

## **Exhibit B Project Description**

### **Boardman to Hemingway Transmission Line Project**



*1221 West Idaho Street  
Boise, Idaho 83702*

Mark Stokes, Project Leader  
(208) 388-2483  
[mstokes@idahopower.com](mailto:mstokes@idahopower.com)

Zach Funkhouser, Permitting  
(208) 388-5375  
[zfunkhouser@idahopower.com](mailto:zfunkhouser@idahopower.com)

*Application for Site Certificate*

*September 2018*

## TABLE OF CONTENTS

1.0	INTRODUCTION .....	B-1
1.1	Project Overview .....	B-1
1.2	Overview of the Need for the Project .....	B-5
2.0	APPLICABLE RULES AND SECOND AMENDED PROJECT ORDER PROVISIONS.....	B-6
2.1	Site Certificate Application Requirements .....	B-6
2.2	Second Amended Project Order Provisions.....	B-8
3.0	ANALYSIS .....	B-9
3.1	Corridor Selection Assessment.....	B-9
3.1.1	Initial Study Area: Constraints and Opportunities.....	B-9
3.1.2	Corridor Selection Process – Phase One (2008–2010) .....	B-24
3.1.3	Corridor Selection Process Phase Two – September 2010 to February 2013 .....	B-34
3.1.4	Corridor Selection Process Phase Three – February 2013 to May 2016.....	B-39
3.1.5	Corridor Selection Process Phase Four – May 2016 to Present.....	B-41
3.1.6	Analysis of Factors from OAR 345-021-0010(1)(b)(D)(i)-(viii) .....	B-42
3.2	Description of Proposed Facility.....	B-48
3.2.1	Electrical Generating Capacity .....	B-48
3.2.2	Major Components .....	B-48
3.2.3	Site Plan and General Arrangement.....	B-68
3.2.4	Fuel and Chemical Storage Facilities .....	B-69
3.2.5	Equipment and Systems for Fire .....	B-69
3.3	Related and Supporting Facilities.....	B-71
3.3.1	Access Roads.....	B-71
3.3.2	Multi-use Areas.....	B-74
3.3.3	Pulling and Tensioning Sites .....	B-77
3.3.4	Communication Station Distribution Lines.....	B-78
3.4	Approximate Dimensions .....	B-78
3.5	Information Required for Transmission Line Projects .....	B-83
3.5.1	Transmission Line Length .....	B-83
3.5.2	Proposed ROW Width .....	B-83
3.5.3	Where Following Public ROW .....	B-84
3.5.4	Pipeline Operating Pressure and Delivery Capacity.....	B-84
3.5.5	Rated Voltage, Load Carrying Capacity Current and Structures.....	B-84
3.6	Construction Schedule .....	B-85
3.7	Limitations on Use of the Right-of-Way (Second Amended Project Order Comments).....	B-85
3.8	Areas of the Site Boundary Where Surveys Have Been Completed.....	B-86
4.0	CONCLUSIONS.....	B-86
5.0	COMPLIANCE CROSS-REFERENCES.....	B-86
6.0	RESPONSE TO NOTICE OF INTENT AND SCOPING MEETING COMMENTS .....	B-89
7.0	REFERENCES .....	B-89

## LIST OF TABLES

Table B-1. Counties in the Study Area.....	B-10
Table B-2. 2008–2010 Siting Constraints Table .....	B-14
Table B-3. Siting Opportunities .....	B-20
Table B-4. Comparison of OAR 345-021-0010(1)(b)(D) Factors by Corridor .....	B-33
Table B-5. Proposed and Alternative Corridor Adjustments since Informational Meetings (August 2010).....	B-34
Table B-6. Proposed and Alternative Corridor Adjustments (macro changes) since Preliminary Application for Site Certificate (February 2013) .....	B-39
Table B-7. Miles of Route Modifications as a Result of BLM Agency Preferred Alternative ...	B-42
Table B-8. Proposed Route Structure Characteristics.....	B-50
Table B-9. Alternative Routes Structure Characteristics.....	B-51
Table B-10. Foundation Excavation Dimensions .....	B-63
Table B-11. Fire Suppression Responsibilities in Oregon .....	B-70
Table B-12. Summary of Access Road Classifications.....	B-72
Table B-13. Project Structures and Visible Feature Dimensions .....	B-78
Table B-14. Compliance Requirements and Relevant Cross-References.....	B-86
Table B-15. Responses to Comment Summaries.....	B-89

## LIST OF FIGURES

Figure B-1. Location Map.....	B-3
Figure B-2. Detail of Alternatives and 230-kV and 138-kV Rebuilds .....	B-4
Figure B-3. Study Area .....	B-11
Figure B-4. Selected Key Constraints.....	B-13
Figure B-5. Goal 3 and Goal 4 Resource Land within the Study Area.....	B-19
Figure B-6. Existing Extra High Voltage Lines in the Study Area .....	B-23
Figure B-7. Community Advisory Process .....	B-24
Figure B-8. Initial CAP Identified Corridors .....	B-26
Figure B-9. Revised CAP Corridors .....	B-27
Figure B-10. Regional Analyses .....	B-29
Figure B-11. Southwest Region Analysis.....	B-30
Figure B-12. Permitting, Construction, and Mitigation Analysis (Southwest Region) .....	B-31
Figure B-13. Alternative Corridors .....	B-32
Figure B-14. Illustration of Transmission Line Components .....	B-49
Figure B-15. Proposed 500-kV Single-Circuit Lattice Steel Structure.....	B-52
Figure B-16. Alternative 500-kV Single-Circuit Tubular Steel Pole Y-Frame Structure .....	B-53
Figure B-17. Proposed/Alternative 500-kV Single-Circuit Tubular Steel Pole H-Frame Structure.....	B-54
Figure B-18. Proposed/Alternative 500-kV Single-Circuit Tubular Steel Pole H-Frame Structure.....	B-55
Figure B-19. Proposed Route Rebuild Single-Circuit 230-kV Steel H-Frame Structure .....	B-56
Figure B-20. Proposed Route Rebuild Single-Circuit 138-kV Wood H-Frame Structure .....	B-57
Figure B-21. 500-kV ROW Designs .....	B-60
Figure B-22. Proposed/Alternative 500-kV ROW Designs.....	B-61
Figure B-23. Alternative 500-kV ROW Designs .....	B-61
Figure B-24. 230-kV and 138-kV ROW Designs.....	B-62
Figure B-25. Typical 500-kV Station .....	B-67
Figure B-26. Typical Communication Station Site Layout.....	B-68
Figure B-27. Multi-use Area Layout .....	B-76
Figure B-28. Light-Duty Fly Yard on Pulling and Tensioning Site Layout .....	B-77

## **LIST OF ATTACHMENTS**

- Attachment B-1. 2010 Siting Study
- Attachment B-2. 2012 Supplemental Siting Study
- Attachment B-3. Comparison of Western, Central, and Eastern Corridors
- Attachment B-4. 2015 Supplemental Siting Study
- Attachment B-5. Road Classification Guide and Access Control Plan
- Attachment B-6. 2017 Supplemental Siting Study
- Attachment B-7a. Wetlands and Waters of the State Areas of the Site Boundary with Completed Surveys
- Attachment B-7b. Cultural Resources Areas of the Site Boundary with Completed Surveys

## ACRONYMS AND ABBREVIATIONS

AC	alternating current
ACEC	Area of Critical Environmental Concern
Amended pASC	Amended Preliminary Application for Site Certificate (July 19, 2017)
ANSI	American National Standards Institute
ASC	Application for Site Certificate
B2H	Boardman to Hemingway Transmission Line Project
BLM	Bureau of Land Management
BPA	Bonneville Power Administration
CAP	Community Advisory Process
DOE	United States Department of Energy
EFSC or Council	Energy Facility Siting Council
EFU	exclusive farm use
EHV	extra high voltage
EIS	Environmental Impact Statement
FERC	Federal Energy Regulatory Commission
GIS	geographic information system
I-84	Interstate 84
ICCP	impressed current cathodic protection
IPC	Idaho Power Company
IRP	integrated resource plan
kV	kilovolt
MW	megawatt
NEPA	National Environmental Policy Act of 1969
NERC	North American Electric Reliability Corporation
NESC	National Electrical Safety Code
NHOTIC	National Historic Oregon Trail Interpretive Center
NOI	Notice of Intent
NWSTF Boardman	Naval Weapons Systems Training Facility Boardman
OAR	Oregon Administrative Rule
OATT	Open Access Transmission Tariff
ODFW	Oregon Department of Fish and Wildlife
ODOE	Oregon Department of Energy
ODOT	Oregon Department of Transportation
OPGW	optical ground wire
ORS	Oregon Revised Statutes
pASC	Preliminary Application for Site Certificate (February 27, 2013)
PAT	Project Advisory Team
PEIS	Programmatic Environmental Impact Statement
PGE	Portland General Electric
Project	Boardman to Hemingway Transmission Line Project
ROW	right-of-way
Second Amended	Second Amended Project Order, Regarding Statutes, Administrative

Project Order	Rules, and Other Requirements Applicable to the Proposed BOARDMAN TO HEMINGWAY TRANSMISSION LINE (July 26, 2018)
USFS	United States Forest Service
WAGS	Washington ground squirrel
WECC	Western Electricity Coordinating Council
WWE	West-wide Energy

## Exhibit B Project Description

### 1.0 INTRODUCTION

Exhibit B provides information about the Boardman to Hemingway Transmission Line Project (Project or B2H), the Project construction schedule, and temporary disturbances of the Project site.

### 1.1 Project Overview

Idaho Power Company (IPC) is proposing to construct, operate, and maintain a high-voltage electric transmission line between Boardman, Oregon, and the Hemingway Substation in southwestern Idaho as an extension of IPC's electric transmission system. This Application for Site Certificate (ASC) seeks authorization for the Project features within the Site Boundary located in Oregon and not Idaho.<sup>1</sup> The Site Boundary for the 500-kilovolt (kV) transmission line is a 500-foot-wide area within which IPC will locate the transmission line and is described in Exhibit C, Section 3.5, Site Boundary. The Site Boundary for the remaining Project features varies by the type of feature (see Exhibit C, Section 3.5, Table C-24).

The Project consists of approximately 296.6 miles of electric transmission line, with 272.8 miles located in Oregon and 23.8 miles in Idaho. The Project includes 270.8 miles of single-circuit 500-kV transmission line, removal of 12 miles of existing 69-kV transmission line, rebuilding of 0.9 mile of a 230-kV transmission line, and rebuilding of 1.1 miles of an existing 138-kV transmission line into a new right-of-way (ROW). Proposed ROW widths are discussed in Section 3.5.2.

The Site Certificate will authorize the following Project features in Oregon:

- **Transmission Lines.** The Proposed Corridor consists of an approximately 270.8-mile-long single-circuit 500-kV electric transmission line, removal of 12 miles of existing 69-kV transmission line, rebuilding of 0.9 mile of a 230-kV transmission line, and rebuilding of 1.1 miles of an existing 138-kV transmission line into a new ROW.<sup>2</sup> The ASC includes four alternative routes of the Proposed Corridor, totaling approximately 33.3 miles of transmission line.
- **Station.** IPC proposes to build a 20-acre switching station (station) located near the Port of Morrow, Oregon. A switching station provides a combination of switching, protection, and control equipment arranged to provide circuit protection and system switching flexibility for the transfer of electric power, but does not incorporate step-down or step-up voltage equipment.<sup>3</sup> The proposed station will serve to connect the Project to other 500-kV transmission lines and the Pacific Northwest power market. For ease of reference, both the proposed switching station and the Hemingway Substation are referred to simply as "stations" throughout this ASC.
- **Communication Station Sites.** Communication station sites will consist of a communication shelter and related facilities. The Project will include 10 communication station sites of less than 1/4-acre in size and 2 alternative communication station sites.

<sup>1</sup> ODOE has jurisdiction over the features located in Oregon and not Idaho. While the ASC discusses the Project features located in Idaho, it does so only to provide context for the analysis related to the Oregon Project features.

<sup>2</sup> The Project features located in Idaho would include an additional 23.8 miles of transmission line leading to the Hemingway Substation.

<sup>3</sup> A switching station is not a substation, which provides the additional function of stepping voltage up and down to allow for distribution to customers. The Project does not include a substation.

- **Related and Supporting Facilities.** The Project will include permanent access roads for the Proposed Route, including 206.3 miles of new roads and 223.2 miles of existing roads requiring substantial modification, and for the alternative routes including 30.2 miles of new roads and 22.7 miles of existing roads requiring substantial modification (see Attachment B-5 – Road Classification Guide and Access Control Plan).
- **Temporary Features.** The Project will include 30 temporary multi-use areas and 299 temporary pulling and tensioning sites, of which four will have light-duty fly yards within the pulling and tensioning sites.

A map of the Project location is set forth in Figure B-1 and details of the alternatives and rebuild routes are shown in Figure B-2. Additional information regarding the location of the Project features is set forth in Exhibit C.



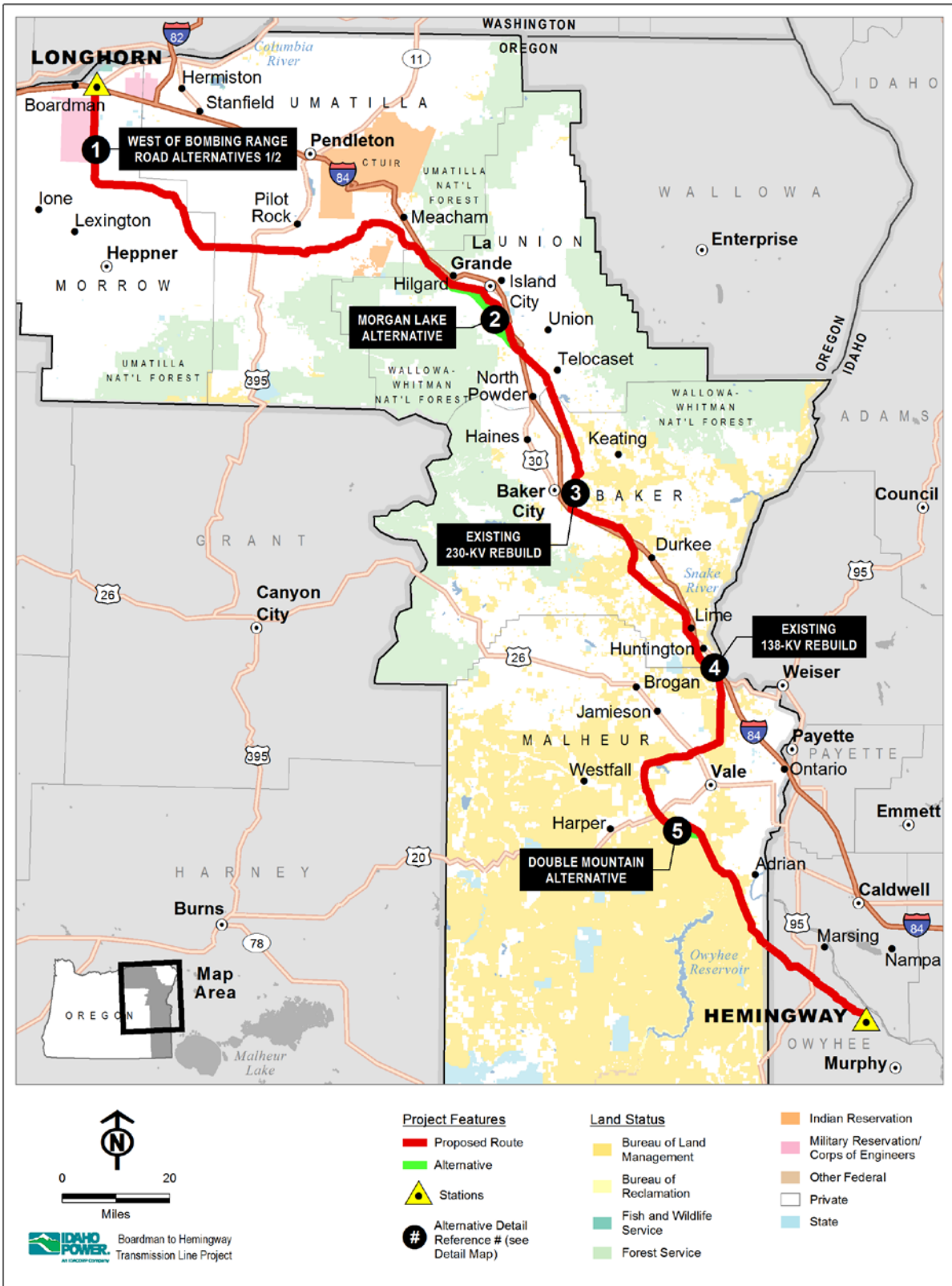

Figure B-1. Location Map

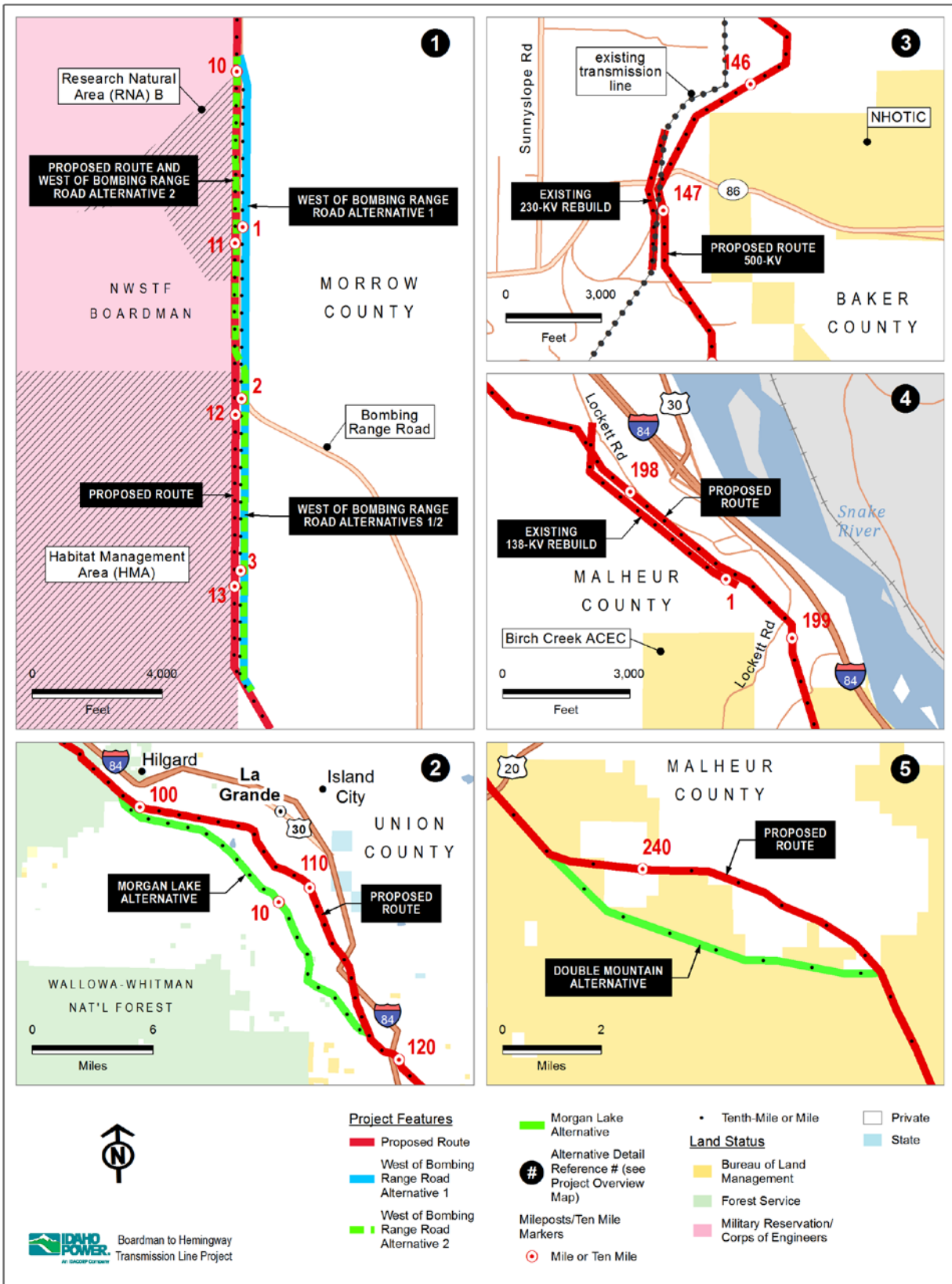

Figure B-2. Detail of Alternatives and 230-kV and 138-kV Rebuilds

## 1.2 Overview of the Need for the Project

As described in greater detail in Section 3.1 (Corridor Selection Assessment), the location of the Proposed Corridor for the Project has been both driven and limited by the nature of IPC's need for the Project. In order to provide enough background and context to support the Corridor Selection Assessment in Section 3.1, this section provides a high-level summary of IPC's need for the Project. For a detailed technical analysis of how the Project complies with the Energy Facility Siting Council's (EFSC or Council) "need" standard, see Exhibit N.

IPC is required, by both federal and state laws, to plan for and meet load and transmission requirements. Through those planning efforts, IPC identified a 500-kV transmission line between southwest Idaho and the Boardman area in north-central Oregon as a least-cost resource that would enable IPC to meet forecasted load and transmission obligations. Accordingly, IPC has identified a transmission line (now known as the B2H Project) as a critical component of an overall resource portfolio that best balances both cost and risk for more than a decade. As explained in detail in Exhibit N, Section 3.2.2, both the Idaho and Oregon public utility commissions have repeatedly acknowledged resource portfolios that identify the Project as a key resource.

The Project will enable IPC to accomplish the following three critical objectives:

- **Serve Native Loads.** The primary objective of the Project is to create additional transmission capacity that would allow IPC to import power from the Pacific Northwest market to serve its retail customers located in the states of Idaho and Oregon. Historically, IPC has been a "summer peaking" utility, while most other utilities in the Pacific Northwest experience system peak loads during the winter. Currently, however, IPC does not have adequate transmission capacity to increase its on-peak power purchases on the western side of its system. As described in the Company's 2013 and 2015 Integrated Resource Plans (IRP), the Project will remedy this transmission constraint by allowing IPC to import an average of 350 megawatts (MW) (500 MW in the summer, 200 MW in the winter) of market purchases to serve its native load (IPC 2013, 2015). In this way, the Project is properly viewed as a supply-side resource, similar to a generation plant, which will allow IPC to meet its expected loads. Further, better access to the Pacific Northwest power market is critical because that market is very liquid with a high number of participants and transactions. On the other hand, the accessible power markets south and east of IPC's system tend to be smaller, less liquid, and have greater transmission distances. Historically, during IPC's peak-hour load periods, off-system market purchases from the south and east have proven to be unavailable or very expensive. Many of the utilities to the south and east of IPC also experience a summer peak, and the weather conditions that drive IPC's summer peak-hour load are often similar across the Intermountain Region. Therefore, IPC imports from the Intermountain Region are not a viable alternative to the Project.
- **Meet Transmission Reliability Standards.** The Project is an integral component of regional transmission planning because it will serve as a crucial high-capacity connection between two key points in the existing bulk electric system that currently lack sufficient transmission capacity. The Project will relieve congestion of the existing transmission system and enhance the reliable, efficient, and cost-effective energy transfer capability between the Pacific Northwest and Intermountain regions. The addition of B2H to the regional grid would create additional redundancy in pathways that will enable IPC and other transmission providers to maintain reliable electric service pursuant to the standards set forth by the North American Electric Reliability Corporation (NERC) and implemented by the Western Electricity Coordinating Council (WECC).

- **Provide Transmission Service to Wholesale Customers.** The Project allows IPC to comply with the requirements of the Federal Energy Regulatory Commission (FERC), which require IPC to construct adequate transmission infrastructure to provide service to wholesale customers in accordance with IPC's Open Access Transmission Tariff. IPC expects interconnection and transmission requests to continue as renewable resources are developed throughout the region.

Through study and planning, IPC concluded that the three Project objectives—to provide additional capacity for the delivery of up to 500 MW of needed energy to IPC's service area, alleviate reliability constraints, and relieve existing transmission congestion in the region—would best be met by connecting IPC's existing transmission system to the existing Pacific Northwest 500-kV transmission grid. These three Project objectives led directly to the identification of the Project's north and south endpoints. IPC identified one endpoint in the Boardman, Oregon, area because it is the easternmost point at which IPC can feasibly interconnect to the Pacific Northwest market. Through system modeling and coordination with other transmission providers, IPC identified two possible interconnection points in the Boardman area (the Boardman–Slatt 500-kV transmission line or the McNary-Coyote Springs 500-kV transmission line). IPC identified the other endpoint as IPC's existing Hemingway Substation because it is the westernmost point in IPC's existing transmission system that could accommodate termination of a 500-kV transmission line.

With these two key endpoints in mind, IPC's corridor selection process involved evaluation of an 11-county study area as shown in Figure B-3 (in Section 3.1.1) and a virtually unlimited number of possible corridors that could connect the identified endpoints. As illustrated in a broad sense in Figure B-4 (in Section 3.1.1.1), which shows selected key constraints, the study area identified by IPC includes an extremely complex assortment of siting constraints, including the following:

- Extensive areas of agricultural land and land zoned exclusive farm use (EFU);
- Areas of the National System of Public Lands administered by the Bureau of Land Management (BLM), United States Forest Service (USFS), and other federal agencies charged with managing the numerous resources in the mountains and high desert; and
- The presence of many sensitive resources, including key wildlife habitat, protected areas, and cultural resources.

The Proposed Corridor described in this ASC is the result of an extensive corridor selection process that has occurred over 9 years and three phases, described more fully in Section 3.1.

## **2.0 APPLICABLE RULES AND SECOND AMENDED PROJECT ORDER PROVISIONS**

### **2.1 Site Certificate Application Requirements**

Oregon Administrative Rule (OAR) 345-021-0010(1)(b) provides Exhibit B must include the following information about the proposed facility, construction schedule, and temporary disturbances of the site:

*(A) A description of the proposed energy facility, including as applicable:*

...

*(ii) Major components, structures, and system, including a description of the size, type and configuration of equipment used to generate electricity and useful thermal energy;*

- (iii) A site plan and general arrangements of buildings, equipment and structures;*
- (iv) Fuel and chemical storage facilities, including structures and systems for spill containment;*
- (v) Equipment and systems for fire prevention and control.*

...

*(B) A description of major components, structures, and systems of each related or supporting facility.*

*(C) The approximate dimensions of major facility structures and visible features.*

*(D) If the proposed energy facility is a pipeline or a transmission line or has, as a related or supporting facility, a transmission line or pipeline that, by itself, is an energy facility under the definition in ORS 469.300, a corridor selection assessment explaining how the applicant selected the corridor(s) for analysis in the application. In the assessment, the applicant shall evaluate the corridor adjustments the Department has described in the project order, if any. The applicant may select any corridor for analysis in the application and may select more than one corridor. However, if the applicant selects a new corridor, then the applicant must explain why the applicant did not present the new corridor for comment at an informational meeting under OAR 345-015-0130. In the assessment, the applicant shall discuss the reasons for selecting the corridor(s), based upon evaluation of the following factors:*

- (i) Least disturbance to streams, rivers and wetlands during construction.*
- (ii) Least percentage of the total length of the pipeline or transmission line that would be located within areas of Habitat Category 1, as described by the Oregon Department of Fish and Wildlife.*
- (iii) Greatest percentage of the total length of the pipeline or transmission line that would be located within or adjacent to public roads and existing pipeline or transmission line rights-of-way.*
- (iv) Least percentage of the total length of the pipeline or transmission line that would be located within lands that require zone changes, variances or exceptions.*
- (v) Least percentage of the total length of the pipeline or transmission line that would be located in a protected area as described in OAR 345-022-0040.*
- (vi) Least disturbance to areas where historical, cultural or archaeological resources are likely to exist.*
- (vii) Greatest percentage of the total length of the pipeline or transmission line that would be located to avoid seismic, geological and soils hazards.*
- (viii) Least percentage of the total length of the pipeline or transmission line that would be located within lands zoned for exclusive farm use.*

*(E) If the proposed energy facility is a pipeline or transmission line or has, as a related or supporting facility, a transmission line or pipeline of any size:*

- (i) The length of the pipeline or transmission line.*
- (ii) The proposed right-of-way width of the pipeline or transmission line, including to what extent new right-of-way will be required or existing right-of-way will be widened.*

(iii) If the proposed transmission line or pipeline corridor follows or includes public right-of-way, a description of where the transmission line or pipeline would be located within the public right-of-way, to the extent known. If the applicant proposes to locate all or part of a transmission line or pipeline adjacent to but not within the public right-of-way, describe the reasons for locating the transmission line or pipeline outside the public right-of-way. The applicant must include a set of clear and objective criteria and a description of the type of evidence that would support locating the transmission line or pipeline outside the public right-of-way, based on those criteria.

(iv) For pipelines, the operating pressure and delivery capacity in thousand cubic feet per day and the diameter and location, above or below ground, of each pipeline.

(v) For transmission lines, the rated voltage, load carrying capacity, and type of current and a description of transmission line structures and their dimensions.

(F) A construction schedule including the date by which the applicant proposes to begin construction and the date by which the applicant proposes to complete construction. Construction is defined in OAR 345-001-0010. The applicant shall describe in this exhibit all work on the site that the applicant intends to begin before the Council issues a site certificate. The applicant shall include an estimate of the cost of that work. For the purpose of this exhibit, "work on the site" means any work within a site or corridor, other than surveying, exploration or other activities to define or characterize the site or corridor, that the applicant anticipates or has performed as of the time of submitting the application.

## 2.2 Second Amended Project Order Provisions

The Second Amended Project Order states that all paragraphs of OAR 345-021-0010(1)(b) apply to the Project, except paragraphs (A)(i), (vi), (vii), and (viii). The Second Amended Project Order also includes the following discussion:

*The description of the proposed facility in the application will form the basis for the description of the facility in the site certificate. The site certificate will require that IPC build the facility "substantially as described." Exhibit B will also provide the basis for the facility description in the notice of application that ODOE will issue to reviewing agencies and public. Therefore, Exhibit B shall describe the facility in enough detail for members of the public and reviewing agencies to make informed comments. Exhibit B shall describe the facility sufficiently for ODOE staff to verify that the constructed project will meet any representations that are the basis for findings of compliance with applicable regulations for standards. It is recommended IPC not include descriptive material that IPC would not want to be held to in a site certificate condition.*

*The application must clearly describe the width of the corridor in which the micro-siting corridor right-of-way would be sited along the length of the proposed line. The application must specify the width of the permanent right-of-way IPC will request, and must justify that width.*

*The application shall describe all related or supporting facilities that the applicant proposes to be included in and governed by the site certificate, including proposed multiple use areas, fly yards, and access roads. For existing roads or road segments that will be included as related or supporting facilities, include a general description of the proposed modifications and improvements. For multiple use areas and fly yards, include a description of the activities that are expected to occur at these areas.*

*The alternatives analysis described in section OAR 345-021-0010(1)(b)(D) must be consistent with the analysis required by ORS 215.275 and the required information in this rule. The Council recognizes that some of the factors in this rule compete with one another (for example, the requirements to both avoid habitat and avoid agricultural land), but expects the application to demonstrate that all required factors were considered.*

(Second Amended Project Order, Section III(b)).

### 3.0 ANALYSIS

Exhibit B describes how and why IPC selected the Project and its Proposed Corridor, and provides information regarding the Project facilities (major components, structures, and systems).<sup>4</sup> Section 3.0 provides the information required by OAR 345-021-0010(1)(b) in the following order:

- Section 3.1 Corridor Selection Assessment
- Section 3.2 Description of the Proposed Facility
- Section 3.3 Related and Supporting Facilities
- Section 3.4 Approximate Dimensions
- Section 3.5 Information Required for Transmission Line Projects
- Section 3.6 Construction Schedule
- Section 3.7 Limitations on Use of the Right-of-Way

#### 3.1 Corridor Selection Assessment

OAR 345-021-0010(1)(b)(D): If the proposed energy facility is a pipeline or a transmission line or has, as a related or supporting facility, a transmission line or pipeline that, by itself, is an energy facility under the definition in ORS 469.300, a corridor selection assessment explaining how the applicant selected the corridor(s) for analysis in the application. . .

IPC's corridor selection process occurred primarily in four phases: Phase One between 2008 and 2010, Phase Two between 2010 and 2012, Phase Three between 2012 and 2015, and Phase Four in 2016. In 2010, IPC developed the original Siting Study detailing the company's siting process for the Project (see Attachment B-1, 2010 Siting Study). IPC developed three supplements to the Siting Study, describing changes to the Project corridor and location of the Project features (see Attachment B-2, 2012 Supplemental Siting Study; Attachment B-4, 2015 Supplemental Siting Study; and Attachment B-6, 2017 Supplemental Siting Study).<sup>5</sup> The following discussion summarizes IPC's general approach to siting, each phase of IPC's corridor selection process, and how IPC selected its Proposed Corridor based on careful consideration of numerous siting criteria, including the eight factors set forth in OAR 345-021-0010(1)(b)(D) and the six factors in Oregon Revised Statutes (ORS) 215.275.

##### 3.1.1 Initial Study Area: Constraints and Opportunities

Initially, IPC studied an area extending from Morrow County, Oregon, to the Hemingway Substation in Owyhee County, Idaho. The area included much of eastern Oregon and southwest Idaho as shown in Figure B-3. The study area comprised all or portions of the 11

<sup>4</sup> The specific details regarding the location of the Project and the Project Site Boundary are discussed in Exhibit C.

<sup>5</sup> In the siting studies, the term "route" is used in instead of "corridor." The use of the term "route" in those studies should be considered synonymous with "corridor" for the purposes of this Exhibit.

counties listed in Table B-1 and covered approximately 31,422 square miles, of which 43 percent is privately owned and 57 percent is government-owned.

**Table B-1. Counties in the Study Area**

<b>Oregon Counties</b>	<b>Idaho Counties</b>
Morrow County	Washington County
Umatilla County	Canyon County
Union County	Payette County
Baker County	Owyhee County
Malheur County (portion)	
Grant County	
Harney County (portion)	

The study area included the agricultural area south of the Columbia River, Blue Mountains, high desert, Owyhee Canyon country, and large areas of irrigated farmland on both sides of the Snake River. Urban development is greatest in the Snake River Valley, especially on the Idaho side of the river, and along Interstate 84 (I-84) around Baker City, La Grande, Pendleton, Hermiston, and Boardman. There are four national forests covering large portions of the central mountainous area that are managed by the USFS for a large number of biological, scenic, recreation, and other resources. BLM manages a variety of resources on a large portion of the high desert areas in the southern half of the study area.



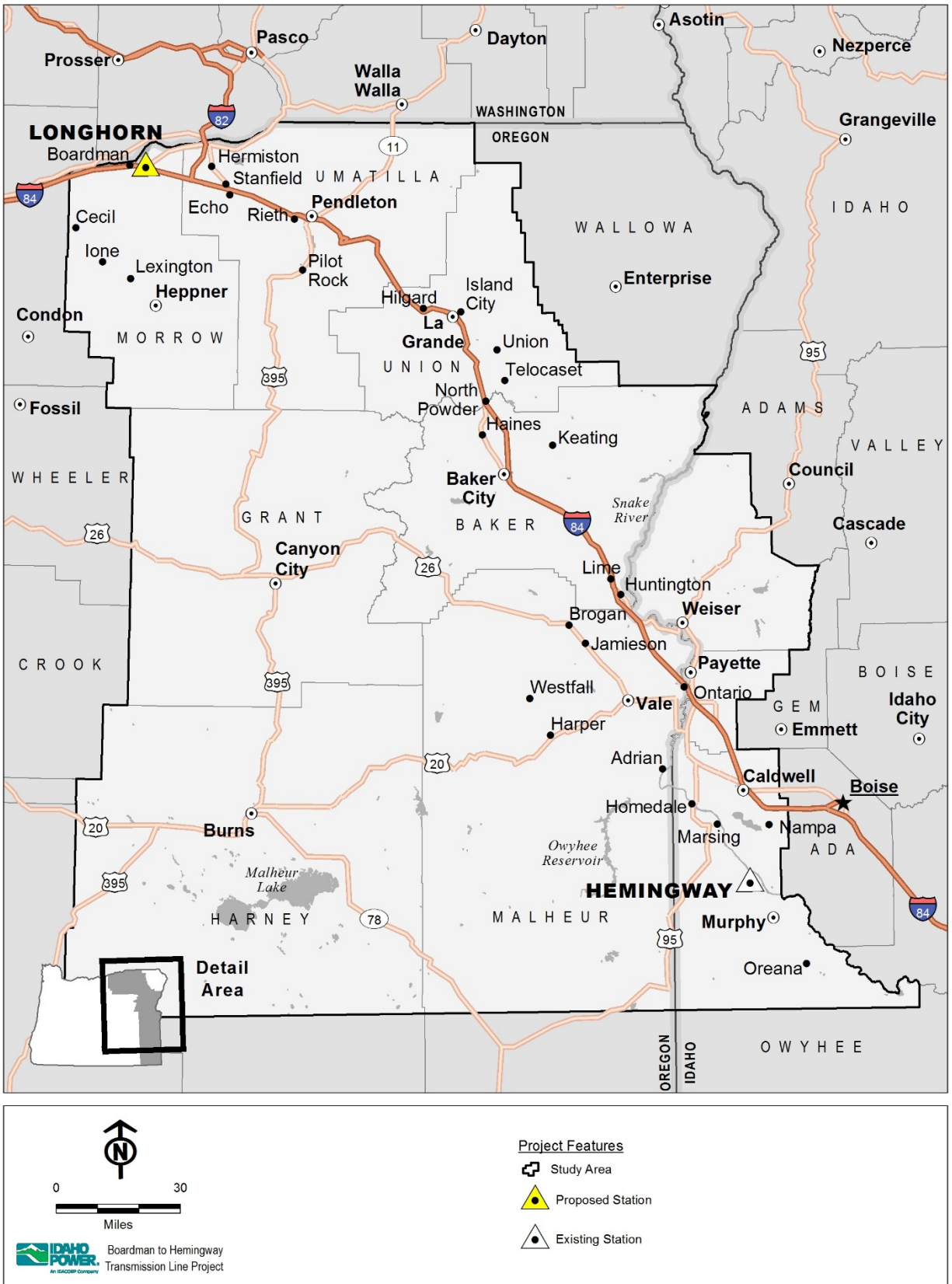

Figure B-3. Study Area

### 3.1.1.1 Constraints

IPC considered certain constraints to identify and evaluate feasible corridors for the development of a new transmission line. IPC defined “constraints” as resources or conditions that potentially limit transmission line siting because of relative sensitivity to facility construction or operation and/or regulatory restrictions. Data collection and meetings with stakeholders resulted in over 200 data sets and helped establish the level of permitting importance from the stakeholder perspective of each constraint for siting alternative corridors. The following is a summary description of the constraints:

**Agricultural Areas** – There are large agricultural areas in the north, in the south, and in Union, Baker and Malheur counties. Northern Morrow and Umatilla counties include many farms with pivot irrigation as well as extensive areas of dryland farming. Union, Baker, and Malheur counties have substantial irrigated agricultural areas in the valley bottoms near the communities of La Grande, Baker City, and Vale. In the south, conditions are similar except that there is more development especially in the Idaho portion of the study area.

**High Desert** – Areas of high desert extend across much of the southern half of the study area up into Baker and Grant counties. Much of the land is managed by BLM and is designated as Areas of Critical Environmental Concern (ACECs), wilderness study areas, and other special resource management areas; there are also large areas of sage-grouse habitat. There are a number of small cities and towns but overall development occupies a small percentage of the high desert.

**Mountainous Area** – The mountainous areas such as the Blue Mountains present very challenging topography with many areas of steep slopes in excess of 35 percent and other areas of unstable slopes presenting design and construction challenges. National forests including the Wallowa-Whitman, Malheur, Umatilla, and Ochoco occupy much of the forested mountainous area (see Figure B-4). Some examples of the most challenging constraints in this area include wilderness areas, wilderness study areas, wild and scenic rivers, special status streams, inventoried roadless areas, and USFS visual quality objectives.

**Land Use Zones** – Under Oregon law, counties are required to zone agricultural lands to achieve compliance with Statewide Planning Goal 3 (Agriculture). Similarly, counties are required to zone forest lands to achieve compliance with Statewide Planning Goal 4 (Forest Lands). The land in the study area is zoned primarily for agricultural and forest uses; urban and non-resource lands are scarce (see Figure B-5). As shown in Figure B-5, Goal 3 resource lands include all lands designated by counties as either a qualifying exclusive farm use zone or a hybrid agriculture/forest zone. Accordingly, the terms “exclusive farm use” or “EFU” are used in this Exhibit to refer to all Goal 3 resource lands (including hybrid zones). Avoidance of EFU land, and particularly irrigated agricultural lands, was a key siting objective. However, because EFU lands cover approximately 77 percent of the study area in Oregon, avoidance of EFU lands was not possible (see Exhibit K, Section 6.3).

**Site-specific Constraints** – Many other more site-specific constraints were considered such as the growing number of wind energy facilities, government-managed lands such as the Naval Weapons System Training Facility Boardman (NWSTF Boardman), historic resources such as the Oregon National Historic Trail, and habitat for protected species such as the Oregon-listed Washington ground squirrel.

Figure B-4 provides an overview of certain key constraints in the Project study area. Table B-2 includes a list of each constraint considered. Figure B-5 identifies the location of Goal 3 or Goal 4 resources in the study area.

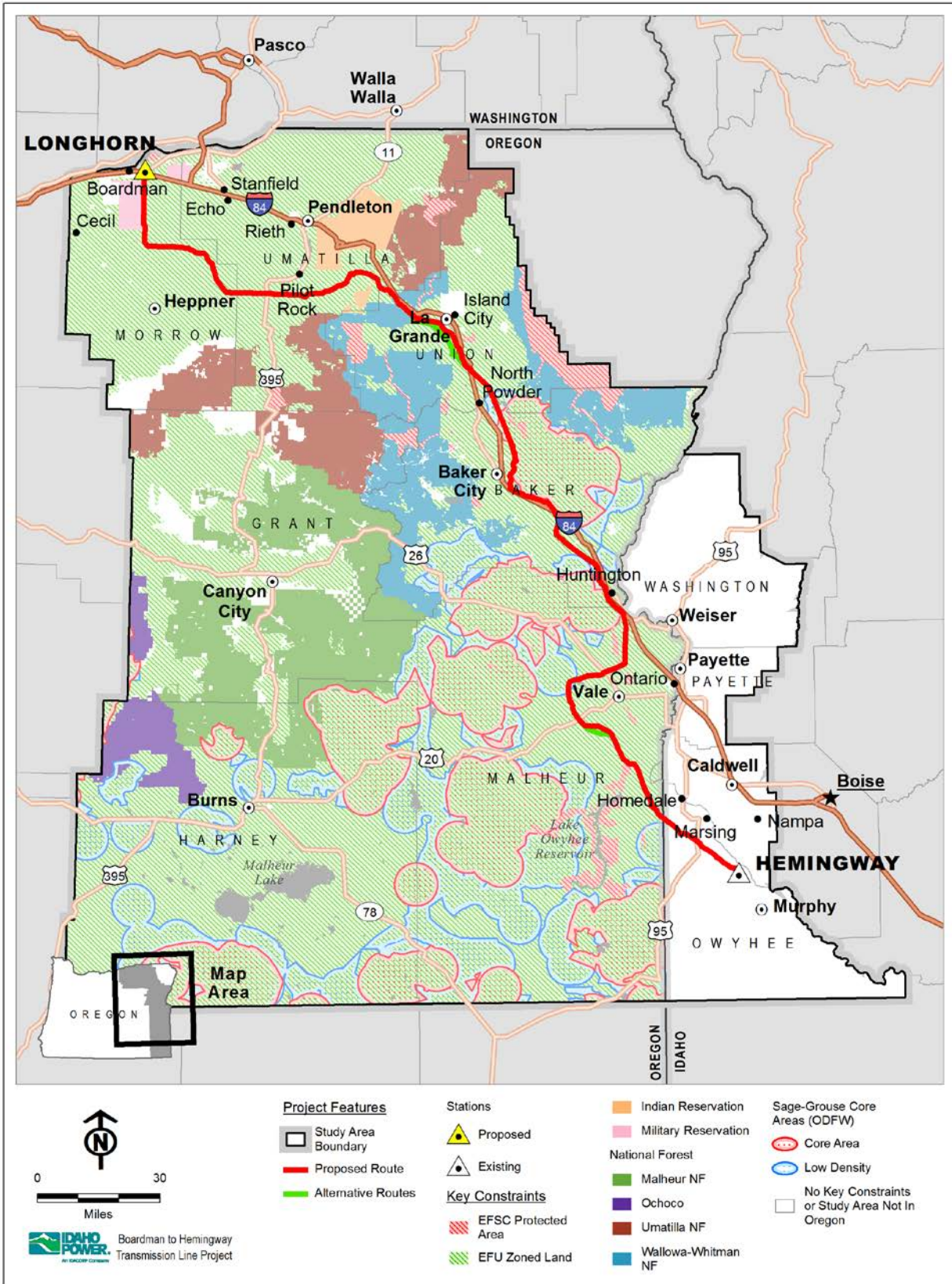

Figure B-4. Selected Key Constraints

**Table B-2. 2008–2010 Siting Constraints Table**

<b>Constraint</b>	<b>Potential OAR 345-021-0010(1)(b)(D) Siting Factor</b>
<b>Cultural Resources</b>	
Burns District Archaeological Site	vi
Burns District Traditional Use Areas	vi
Cemetery	vi
Intact Oregon Trail Segment (Oregon BLM)	vi
National Historic Oregon Trail Interpretive Center	vi
National Register Historic Point Site	vi
Oregon Trail	vi
Oregon Trail Brochure – Trail rut	vi
Vale District Archaeological Site	vi
Within 0.5 mile of National Register Historic Place Buffer	vi
Within 1,200 foot Historic Trail Buffer	vi
Within 500 feet of Cemetery	vi
<b>Fish and Wildlife</b>	
Burns District Bald Eagle Site	ii
Burns District Raptor Site	ii
ODFW Big Game Deer Winter Range	ii
ODFW Big Game Elk Winter Range	ii
ODFW Bighorn Sheep Range	ii
ODFW Conservation Opportunity Area	ii
ODFW Sage-grouse Lek	ii
Prineville District Fish Restoration Area	ii
Prineville District Wildlife Habitat Seasonal Closure Area	ii
Sage-grouse Core Area 1: Sagebrush Habitat (Oregon)	ii
Sage-grouse Core Area 2: Potential Habitat (Oregon)	ii
Sage-grouse Core Area 3: Non-Sagebrush Shrublands and Grasslands (Oregon)	ii
Washington Ground Squirrel 785ft Buffer	ii
Within 2-mile Oregon Sage-grouse Lek Buffer (Occupied but able to be Permitted)	ii
Within 2-mile Oregon Sage-grouse Lek Buffer (Occupied)	ii
Within 2-mile Oregon Sage-grouse Lek Buffer (Unoccupied)	ii
Within 300ft Special Status Stream/Lake: Bull Trout	i
Within 300ft Special Status Stream: Chinook Salmon	i
Within 300ft Special Status Stream: Coho Salmon	i
Within 300ft Special Status Stream: Cutthroat Trout	i
Within 300ft Special Status Stream: Red Band Trout	i
Within 300ft Special Status Stream: Sockeye Salmon	i
Within 300ft Special Status Stream: Steelhead	i

<b>Constraint</b>	<b>Potential OAR 345-021-0010(1)(b)(D) Siting Factor</b>
<b>Geology and Soils</b>	
Erosion Hazard: High (Natural Resources Conservation Service Soil Data – Grant Co, Oregon data NA)	vii
Erosion Hazard: High (Prineville District, Oregon)	vii
Erosion Hazard: Low (NRCS Soil Data – Grant Co., Oregon data NA)	vii
Erosion Hazard: Moderate (NRCS Soil Data – Grant Co, Oregon data NA)	vii
Fault Line	vii
Oregon Landslide Feature: Fan	vii
Oregon Landslide Feature: Landslide	vii
Oregon Landslide Feature: Talus-Colluvium	vii
Prime Farmland/Arable Land: Soils Class 1-4	vii
U.S. Geological Survey Active Mining Area	vii
Within 500ft of Fault Line	vii
<b>Slope</b>	
Slope 0-15%	vii
Slope 15-25%	vii
Slope 25-35%	vii
Slope >35%	vii
<b>Land Use</b>	
Area of Critical Environmental Concern	v
Birch Creek Interpretive Site	v
BLM Recreation Site (Oregon and Idaho)	v
BLM Wild and Scenic River: Recreation	v
BLM Wild and Scenic River: Scenic	v
BLM Wild and Scenic River: Suitable Lands (Prineville District, Oregon)	v
BLM Wild and Scenic River: Wild	v
BLM Wilderness Study Area (Oregon/Idaho)	v
Burns District Off-Highway Vehicle: Limited	O <sup>1</sup>
Burns District Off-Highway Vehicle: Seasonal Closure	O
Burns District ROW Avoidance Corridor	O
Confederated Tribes of the Umatilla Indian Reservation	O
Cropland/Irrigated Agriculture	O
CTWSR Forrest Conservation Area	O
CTWSR Oxbow Conservation Area	O
Forested Land: Private	iv
Forested Land: Public	iv
Grazing/Pasture – Oregon	O
Hells Canyon National Recreation Area	v
Hospitals	O
Howard Meadows	O

<b>Constraint</b>	<b>Potential OAR 345-021-0010(1)(b)(D) Siting Factor</b>
Irrigated Agriculture/Cropland	O
Lands with Wilderness Characteristics (Oregon BLM)	O
Lower Powder River Valley	O
Morrow County Park	v
National Forest Inventoried Roadless Area	v
National Forest Military Operations Area	O
National Forest Old Growth Forest Stand	ii
National Forest Recreation Site	v
National Forest Special Use Areas	v
National Forest Wilderness Area	v
National Forest: Special Interest Area	v
National Wildlife Refuge	v
Naval Weapons System Training Facility	O
North Powder Valley	O
Noxious Weeds (Oregon BLM)	O
ODFW Wildlife Management Area	v
Oregon Fish Hatcheries	v
Oregon State Park	v
Oregon/Idaho Trails	O
Prineville District Lands Proposed for Acquisition by BLM	O
Prineville District Noxious Weeds	O
Prineville District Off-Highway Vehicle: Closed	O
Prineville District Off-Highway Vehicle: Limited Use	O
Prineville District Old Growth Forest	ii
Prineville District Proposed Area of Critical Environmental Concern	v
Prineville District Special Recreation Management Area	O
Proposed Wilderness Study Area Oregon Natural Desert Association	O
Proposed Wind Farm Boundary (Burns District, Oregon)	O
Restricted Airspace – Airport	O
Special Recreation Management Area (Malheur Resource Management Area, Vale District, Oregon)	v
Starkey Game Management Area	v
The Nature Conservancy: Portfolio	O
The Nature Conservancy: Preserve	O
Thief Valley Reservoir	O
Urban Area	O
Urban Growth Boundary – Oregon	O
Vale District Off-Highway Vehicle: Closed	O
Vale District Off-Highway Vehicle: Limited to Designated Routes	O
Vale District Off-Highway Vehicle: Limited to Existing Routes	O
Virtue Flat OHV Park	O

<b>Constraint</b>	<b>Potential OAR 345-021-0010(1)(b)(D) Siting Factor</b>
Wild Horse and Burro Area (Oregon BLM)	O
Wind Farm Boundary	O
<b>Land Ownership/Management</b>	
Bureau of Land Management	O
Bureau of Reclamation	O
Indian Reservation	O
Military Land	O
National Forest Land	O
National Park Service	v
Other Federal Land	O
Private Land	O
State Land	O
US Fish and Wildlife Service Land	O
<b>Visual Resources</b>	
BLM Visual Resource Management Class 1	O
BLM Visual Resource Management Class 2	O
BLM Visual Resource Management Class 3	O
BLM Visual Resource Management Class 4	O
Devine Scenic Corridor (Burns District)	O
National Forest Scenic Visual Corridor	O
National Forest Visual Quality Objective: Maximum Modification	O
National Forest Visual Quality Objective: Modification	O
National Forest Visual Quality Objective: Partial Retention	O
National Forest Visual Quality Objective: Preservation	O
National Forest Visual Quality Objective: Retention	O
Scenic Byway	O
Viewshed Area (Baker County)	O
Within 1200ft Nationally Designated Scenic Byway	O
<b>Water and Wetlands</b>	
303d Lakes	i
303d Streams	i
Floodplain: 500-yr Flood Zone	i
Floodplain: Area Not Mapped	i
Floodplain: Not in Flood Zone	i
Floodplain: Zone A	i
Floodplain: Zone AE	i
Floodplain: Zone ANI	i
Floodplain: Zone AO	i
National Wetland Inventory	i
Oregon State Scenic Waterway	v
Oregon Watershed Restoration Inventory Facility	i

<b>Constraint</b>	<b>Potential OAR 345-021-0010(1)(b)(D) Siting Factor</b>
(within 500ft Buffer of linear feature)	
Oregon Watershed Restoration Inventory Facility (within 500ft of site location)	i
Oregon Watershed Restoration Inventory Facility Area	i
Snake River	i
<b>Zoning</b>	
Airport	iv
Exclusive Farm Use Zone	viii
Forest	iv
Mineral & Aggregate	iv
Natural Resource	iv
Park	iv
Reserve	iv
Rural Commercial	iv
Rural Industrial	iv
Rural Residential	iv
Rural Service Center	iv
Urban	iv

<sup>1</sup> O – Other than one of the eight factors under OAR 345-021-0010(1)(b)(D).

BLM – Bureau of Land Management; ft – feet; NA – not applicable/available; NRCS – Natural Resources Conservation Service





### 3.1.1.2 Opportunities

In addition to constraints, IPC identified and considered siting “opportunities,” which were defined as resources or conditions that could accommodate transmission line construction and operation because of their physical characteristics or regulatory designations. In the study area, existing transportation corridors (I-84), pipelines, electric transmission lines, and agency-designated energy corridors were considered as potential siting opportunities (see Table B-3). The Proposed Corridor parallels existing transmission lines where possible but maintains an approximate 250-foot separation distance,<sup>6</sup> when possible. In evaluating corridor locations, consideration was also given to paralleling the Hemingway to Summer Lake 500-kV line as well as to the location of the West-wide Energy (WWE) corridor and BLM- and USFS-designated utility corridors.

**Table B-3. Siting Opportunities**

Opportunity	Potential OAR 345-021-0010(1)(b)(D) Siting Factor
<b>Existing Corridors</b>	
Vale District Utility Corridor	iii
West-wide Energy Corridor	iii
National Forest Utility Corridor	iii
Interstate 84	iii
500-kV Transmission Lines	iii
138/230-kV Transmission Lines	iii
Large Diameter Pipeline	iii

#### ***Vale District Utility Corridor***

The BLM Vale District Resource Management Plan (BLM 2002) designated two utility corridors in the vicinity of the Owyhee River below the Owyhee Dam. IPC considered these utility corridors as an opportunity for siting the transmission line across the Owyhee River on public lands. The Proposed Route is sited within the Vale District Utility Corridor for approximately 16.8 miles as shown in Exhibit C, Attachment C-2, maps 92 through 95, map 110, maps 117 through 119, and maps 121 through 124.

#### ***West-wide Energy Corridor***

The BLM, in response to Section 368 of the Energy Policy Act of 2005, participated in a programmatic Environmental Impact Statement (PEIS) for the designation of energy corridors on federal land in the 11 western states (DOE/EIS-0386 [DOE and BLM 2008]), commonly known as Section 368 Corridors, in which the U.S. Department of Energy (DOE) and BLM were the lead federal agencies, and the USFS and other agencies were cooperators. The PEIS designated energy corridors and provided guidance, best management practices, and mitigation measures to be used where linear facilities are proposed crossing BLM-managed and National Forest System lands. Notwithstanding the uncertain legal status of the Section 368 Corridors,<sup>7</sup> IPC considered

<sup>6</sup> As discussed below under “500-kV Transmission Lines,” IPC’s preferred separation distance is 1,500 feet. However, the Proposed Route includes a 250-foot, and not a 1,500-foot, separation distance to bring it in line with BLM’s revised Agency Preferred Alternative.

<sup>7</sup> On July 7, 2009, multiple organizations filed a complaint challenging the PEIS. *Wilderness Society, et al. v. United States Department of the Interior, et al.*, No. 3:09-cv-03048-JW (N.D. Cal.). BLM, USFS, DOE, and the Department of Justice worked collaboratively with the plaintiffs to develop a settlement with specific actions to mutually resolve the challenges in the complaint. The four principal components of the July 3, 2012, Settlement Agreement require the

the Section 368 corridors as siting opportunities on public lands. The Proposed Route is sited within the WWE corridor for approximately 3.9 miles in Baker and Malheur counties as shown in Exhibit C, Attachment C-2, maps 92 through 95, and maps 124 through 125.

### ***National Forest Utility Corridor***

The Wallowa-Whitman National Forest includes a designated utility corridor along I-84 west of La Grande, Oregon, through the Blue Mountains. The utility corridor is designated in order to facilitate authorization of future utility (including transmission) ROWs (USFS 1990) on the Wallowa-Whitman National Forest. The utility corridor currently includes several existing facilities including a 230-kV transmission line, a natural gas pipeline, and a refined petroleum product pipeline. In addition, I-84, segments of old US Route 30, and a Union Pacific railway are also located within this utility corridor. IPC considered the Wallowa-Whitman National Forest utility corridor to provide a key opportunity for siting the transmission line across National Forest System public lands. The Proposed Route is sited within 6.8 miles of the 7.4-mile-long Wallowa-Whitman National Forest utility corridor as shown in Exhibit C, Attachment C-2, maps 46 through 48.

### ***Interstate 84***

The I-84 corridor, in most cases, did not provide an opportunity for siting the transmission line. Several portions of I-84 within the study area are identified in local land use plans as scenic resources. Land use (population centers, occupied structures, irrigated agriculture, and airports), resources (wetlands, floodplains), and topography adjacent to I-84 prevented siting the transmission line in other areas.

Transmission lines and other utilities can be sited along public roads in Oregon as long as they do not obstruct any public road or navigable stream. However, the rights of utilities to construct facilities along public roads are subject to the needs of the public road system (ORS 758.010). If roadway improvements become necessary, relocation of the utility (transmission line) would be subject to the order of the county governing body and the Department of Transportation, and the utility would incur the cost of the relocation.

### ***Extra High Voltage Transmission Lines***

IPC's position throughout the siting of the Project has been that a 1,500-foot minimum separation distance between adjacent extra high voltage (EHV, 230-kV or higher) transmission lines is required to minimize the probability of losing two EHV transmission lines that are a part of the same WECC path in quick succession. The simultaneous loss (N-2 contingency) of the 500-kV B2H Project and another EHV line connecting Idaho to Oregon/Washington possibly would result in significant power outages to customers across Idaho, Wyoming, and Utah, and possibly cascading outages throughout the West (blackouts). Accordingly, throughout the first three siting phases, the proposed transmission line route generally was developed with an approximate 1,500-foot separation distance between adjacent EHV transmission lines.

However, in 2016, the BLM's revised Agency Preferred Alternative included a 250-foot, and not a 1,500-foot, EHV minimum separated distance. Because the Proposed Route follows the revised Agency Preferred Alternative. The Proposed Route now conforms with BLM's directive that the Project use a 250-foot EHV minimum separation distance, which is based on a WECC 2012 whitepaper found at [https://www.wecc.biz/Reliability/FAC-010\\_White%20Paper\\_2-6-13.pdf](https://www.wecc.biz/Reliability/FAC-010_White%20Paper_2-6-13.pdf).

---

federal agencies to complete an interagency Memorandum of Understanding addressing periodic corridor reviews; update agency guidance; update agency training; and complete a corridor study.

There are many EHV transmission lines in Oregon that are along the Columbia River or in the vicinity of the Interstate 84 corridor along the very northern portion of the Study Area (Figure B-6). Those lines run east-west and not south toward the Hemingway Substation. Because the lines in the north do not trend on a path connecting the two Project endpoints, the lines do not provide a siting opportunity that meets the objectives of the Project.

The existing PacifiCorp Hemingway to Summer Lake line is the only EHV transmission line traversing the southern portion of the Study Area (Figure B-6). It too does not trend on a path connecting the Longhorn Station and Hemingway Substation, so the Hemingway to Summer Lake line did not provide an opportunity for siting the majority of the Project. However, the Hemingway to Summer Lake line did provide an opportunity for siting from just inside the eastern edge of Oregon into the Hemingway Substation in southwestern Idaho.

### **230/138/69-kV Transmission Lines**

The Proposed Route is sited within approximately 250 feet of existing 69-kV, 138-kV, or 230-kV transmission lines for 73.6 miles as shown in Exhibit C, Attachment C-2.

### **Large-Diameter Pipeline**

Siting a high-voltage transmission line in close proximity and parallel to a metallic underground pipeline may require the installation or upgrade of protective equipment to mitigate potential corrosion of the pipeline from induced voltage caused by the transmission line. Installation of the protective equipment would require additional infrastructure and ground disturbance associated with the Project.<sup>8</sup> As a general siting principle, IPC carefully scrutinized siting the Project parallel to existing buried pipelines. The cost savings and potential for reduced construction impact of siting adjacent to existing pipelines is weighed against the impact to the underground pipelines and potential mitigation to address the impacts. This has been done to minimize disruption or required modifications to existing protective systems and their supporting infrastructures. As the Project continues to consider new constraint information, IPC will continue to work to avoid interference with underground pipelines as well as other types of existing infrastructure to the maximum extent possible. Where it was not possible to move the Project away from the pipeline, IPC will work with the owner/operator of the pipeline to evaluate the interference from the B2H Project and see that the necessary protection system is put in place to protect the pipeline.

Large-diameter pipelines did not provide a significant opportunity for siting the transmission line. However, the Proposed Route is sited within 250 feet of existing large-diameter gas pipelines for 15.6 miles as shown in Exhibit C, Attachment C-2.

---

<sup>8</sup> Where buried pipelines run parallel to a transmission lines, they are typically protected by an impressed current cathodic protection (ICCP) system, which requires buried anodes connected to a DC-power source, if not already installed by the pipeline owner/operator will generally require construction of a new distribution line to serve the ICCP.

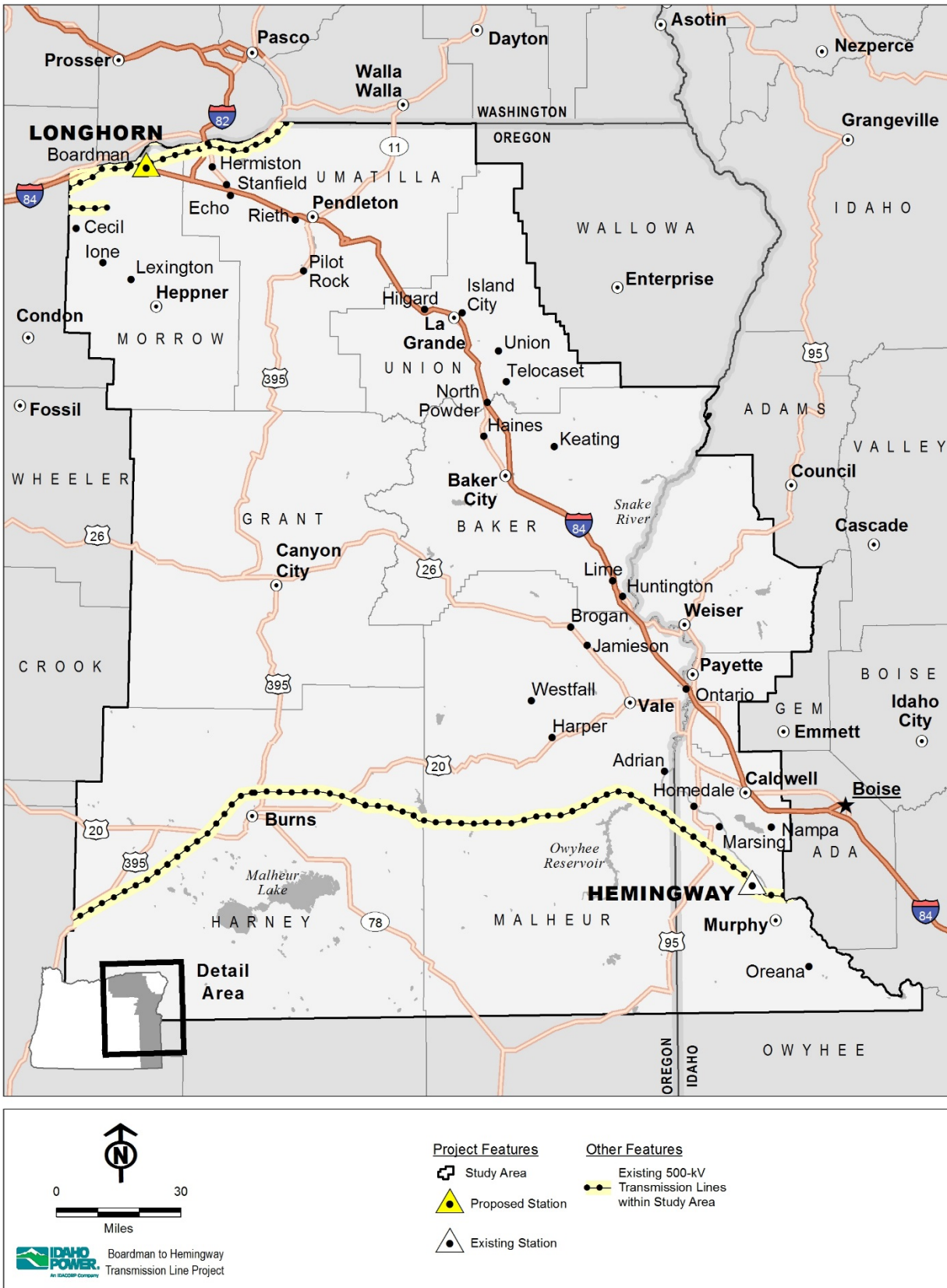
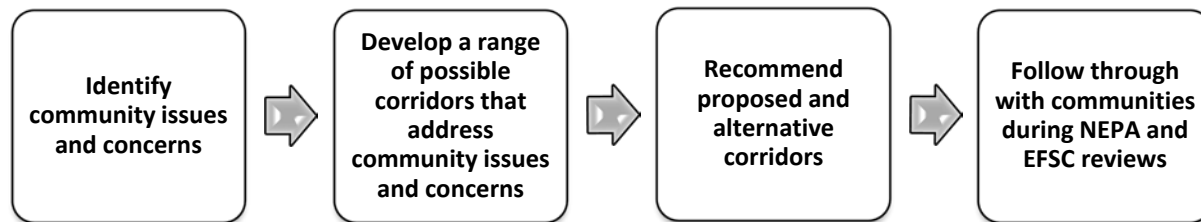

Figure B-6. Existing Extra High Voltage Lines in the Study Area

### 3.1.2 Corridor Selection Process – Phase One (2008–2010)

Phase One of IPC's identification and analysis of potential alternative corridors was accomplished primarily between 2008 and 2010 and involved input from many local citizens residing throughout the 11-county, two-state study area. IPC's originally proposed corridor was presented to the public during scoping meetings conducted by BLM and Oregon Department of Energy (ODOE) in October 2008.<sup>9</sup> Because of the level of public interest, corridor suggestions, and opposition to the originally proposed corridor, IPC initiated a process to engage residents, property owners, business leaders, and local officials in siting the Project. Through this Community Advisory Process (CAP) described below, IPC partnered with communities and other stakeholders from northeast Oregon to southwest Idaho to identify proposed and alternative corridors and station locations for the Project.

IPC's CAP took place in 2009 and early 2010. Project Advisory Teams (PATs) representing five geographic areas were convened for the purpose of identifying, developing, and recommending proposed and alternative corridors for the Project. Figure B-7 shows the process graphically.



**Figure B-7. Community Advisory Process**

The process consisted of the following steps:

1. PATs identified issues and concerns. PATs developed community criteria for evaluating possible corridors and integrated these with regulatory requirements and IPC criteria relating to cost and feasibility.
2. PATs developed a range of possible corridors or corridor segments that addressed community issues and concerns. The PATs developed approximately 48 corridors and corridor segments. Corridors not meeting the community, regulatory or IPC cost/feasibility criteria were removed from further consideration.
3. PATs recommended proposed and alternative corridors were evaluated. IPC analyzed all 48 corridors and corridor segments proposed by the PATs using the processes described in Section 3.1.2.3, and identified three corridors as most constructible, least difficult to permit, and most likely to incur the lowest overall cost.
4. IPC evaluated the three possible corridors based on input received from PATs and selected a proposed corridor. IPC presented three corridors to the PATs for their comments. The resulting comments showed no clear preference for any one of the three corridors. IPC selected the Eastern Corridor as the proposed corridor as described in Section 3.1.2.4.

<sup>9</sup> IPC first submitted a Notice of Intent (NOI) to apply for a site certificate to the ODOE – EFSC in 2008. IPC also submitted applications for the necessary federal ROWs to BLM and USFS, and the federal and state agencies held joint public scoping meetings in October 2008. Following those meetings, IPC initiated a process to re-evaluate the 2008 proposed route and engage residents, property owners, business leaders, and local officials in siting the transmission line. Through the CAP, IPC partnered with communities from northeast Oregon to southwest Idaho to identify potential routes for the Project. Based on input received in the CAP, IPC selected a new proposed route for the Project. Accordingly, IPC withdrew its original NOI and submitted a new NOI to ODOE-EFSC in July 2010, as well as revised applications to BLM, USFS, and Bureau of Reclamation requesting the necessary ROW grants. Both the federal and state application are still pending.

5. Follow through with communities during state and federal reviews. IPC continues communicating with the PATs and public throughout the National Environmental Policy Act of 1969 (NEPA) and ODOE processes. Toward this end, IPC will keep the public and PATs updated on corridor revisions and the rationale for them as well as the status of the regulatory actions, and will continue to receive and address public input.

In addition to PAT meetings, IPC held public meetings throughout the Project area to allow the public to review and comment on the PATs' work and further comment on the Project itself.

### 3.1.2.1 Initial Corridor Selection

IPC compiled a comprehensive geographic information system (GIS) database of constraints and opportunities for the study area. Constraints were then categorized by PATs as exclusion, high avoidance, moderate avoidance, or low avoidance; incorporating input from the PATs, corridor development began with a series of routing meetings and workshops at Baker City, Boardman, and Ontario, Oregon, each of which comprised one evening session followed by a full day of routing. At the evening sessions, IPC educated the participants on the siting process and confirmed community criteria. The next day, individuals and groups of local citizens returned to identify corridor segments or entire corridors between Boardman and Hemingway. Other than providing technical expertise, IPC staff and their contractors did not participate in development of the PAT-derived corridors.

Members of the CAP and other local residents and organizations brought their knowledge of local resources, conditions, and priorities and worked with IPC, GIS analysts and routing experts to identify potential corridors. The GIS analysts, using topographic maps, available aerial photography, and the many GIS layers of constraints and opportunities, worked with participants to identify corridors that avoided exclusion areas and as much as possible minimized crossings of high avoidance constraints and, where practical, moderate and low avoidance areas. In all instances the routing teams were looking for opportunities such as existing transmission lines and the West-wide Energy corridors to parallel or use.

After PATs identified corridors for study in Grant and Harney counties, IPC initiated a formal CAP process and routing sessions were soon held in Mt. Vernon and Hines. Every corridor developed in the five mapping sessions was documented in GIS format and with a form explaining the basis for each corridor or segment. Approximately 47 corridors and corridor segments totaling over 3,000 miles (as shown on Figure B-8) were developed through the CAP.

### 3.1.2.2 Corridor Refinement

Following the routing sessions, IPC reviewed each of the corridors to identify potential issues that could significantly impact the ability to permit a segment or corridor. Each alignment was reviewed using aerial photography, topographic maps, and constraint data. Using aerial photography, houses, barns, and other structures (i.e., wind turbines); irrigation pivots; and other land use constraints could be avoided where practical. Using topographic maps the corridors were adjusted to avoid or minimize distance across very steep slopes and other physical features less desirable for construction and operation of a transmission line. Finally, the corridors were checked against constraint maps to avoid exclusion areas and areas of high permitting difficulty like Oregon Department of Fish and Wildlife (ODFW) Category 1 habitat. In the large majority of instances, changes were made while maintaining the intent of the corridor or corridor segment.

At this time a number of corridors were dropped from further consideration because they did not meet the Project objectives and/or resulted in significantly more environmental impacts and cost. As a result, the miles of corridors for further consideration were reduced to about 2,000 miles. Figure B-9 shows those corridors carried forward as a result of the refinement process.

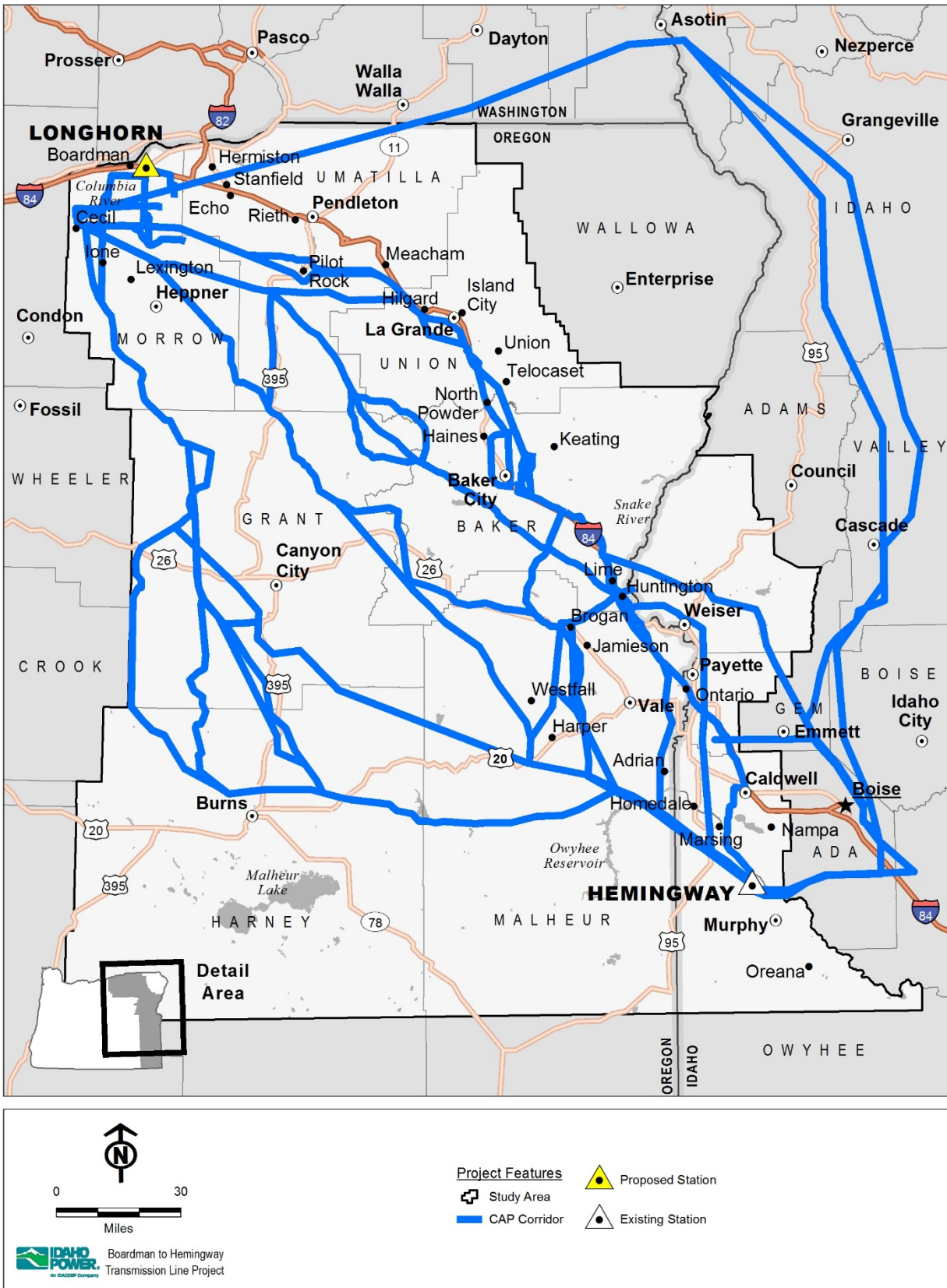

Figure B-8. Initial CAP Identified Corridors



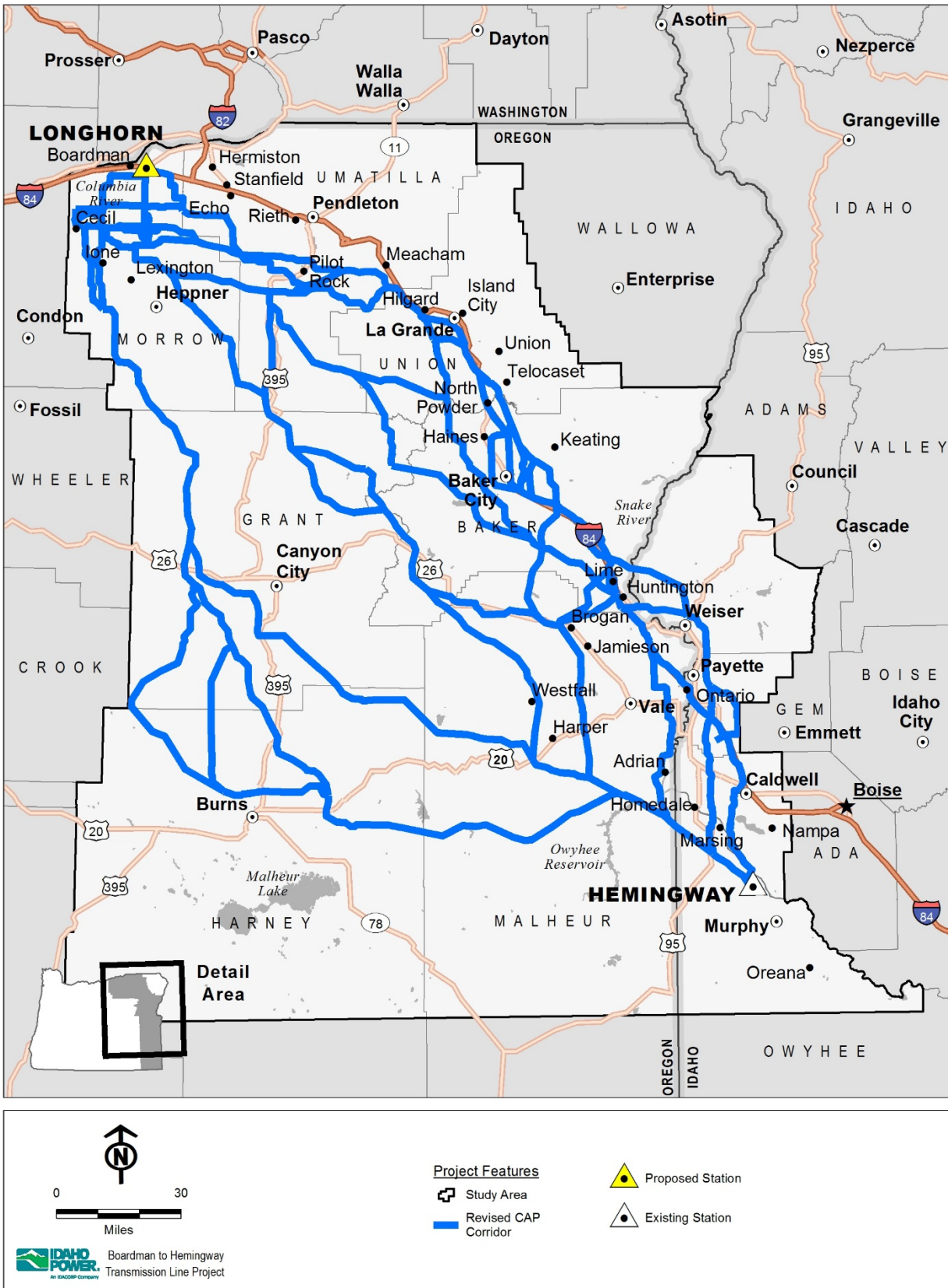

Figure B-9. Revised CAP Corridors

### 3.1.2.3 Regional Analysis

Next, the remaining corridors, where appropriate, were grouped into 14 regions as shown on Figure B-10. Regions were established where two or more corridors extended from one common point to a second common point. For example, in the southwest region, as shown on Figure B-11, four corridors were identified between points GR3 and MA6. Each corridor in this region was then analyzed for permitting difficulty, construction difficulty, and mitigation costs as shown in Figure B-12 for the southwest region (to see regional analysis for each of the 14 regions, see Attachment B-1, 2010 Siting Study, Section 3.3).

In evaluating permitting difficulty, constraints previously identified were categorized as low, moderate, or high permitting difficulty areas or as exclusion areas or opportunities. Next, the miles of each category were measured and totaled and used to compare pairs of corridors within a region. Also, each corridor was analyzed for specific constraints it crossed and these were documented in attribute tables. The tables were reviewed to identify more significant differences between corridors. These two analyses were used to determine the most reasonable corridor in each region.

In evaluating construction difficulty, accessibility, topography, road construction, equipment movement, and many other factors were used to determine low, moderate, and high construction difficulty. Again, these ratings were measured by mile and totaled and used to compare the corridors in a region. In those cases where the permitting analysis was not conclusive, the construction difficulty analysis was considered.

After the permitting and construction difficulty analyses were completed, potential biological mitigation costs were estimated (high, moderate, or low), measured in miles, and totaled for each alternative corridor. Using these three analyses, including the siting factors identified in OAR 345-021-0010(1)(b)(D), a more reasonable corridor was selected for each region and, combining the selected corridors with those unique segments between two points, three corridors were determined for further analysis as shown on Figure B-13.

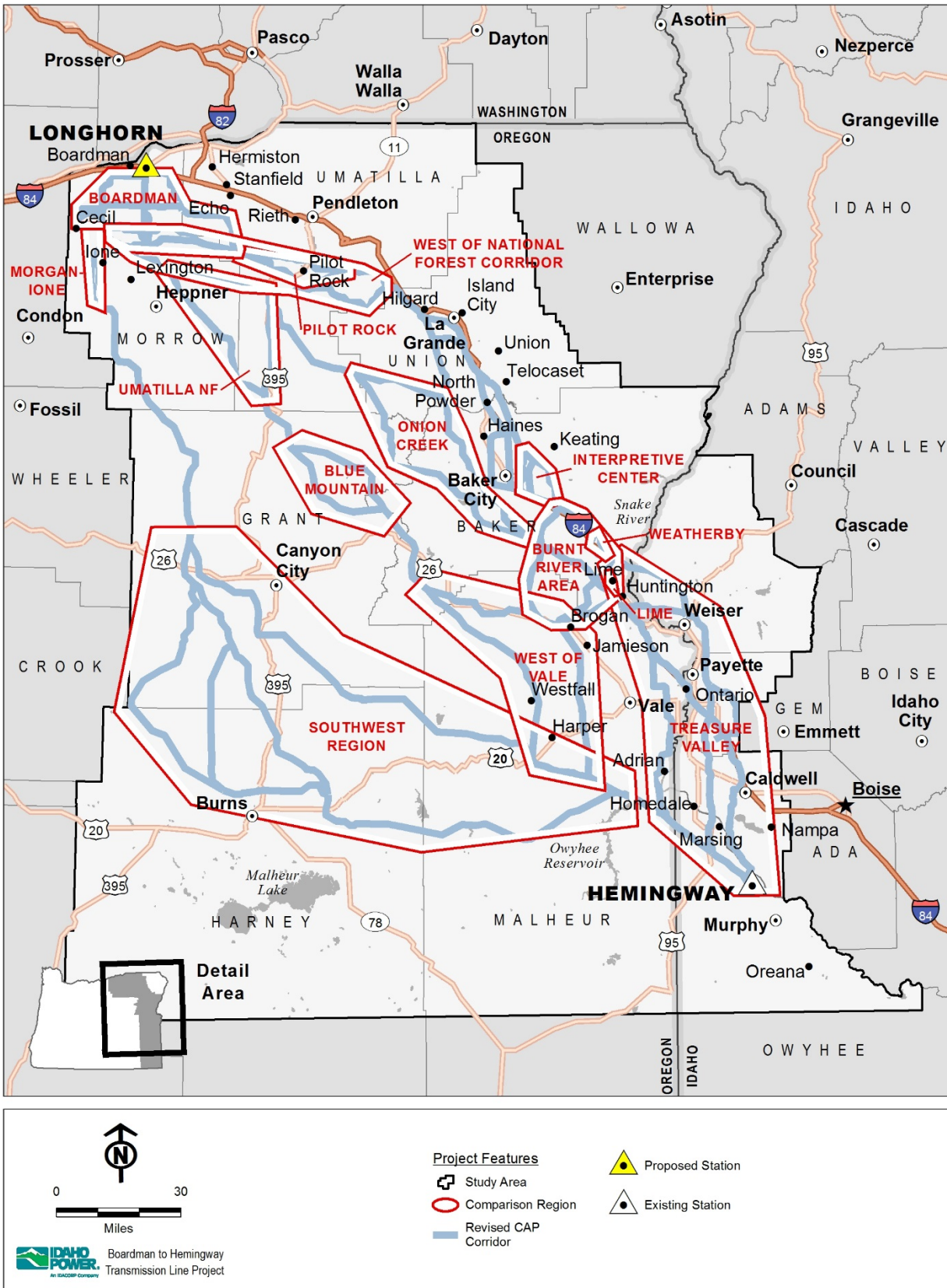

Figure B-10. Regional Analyses

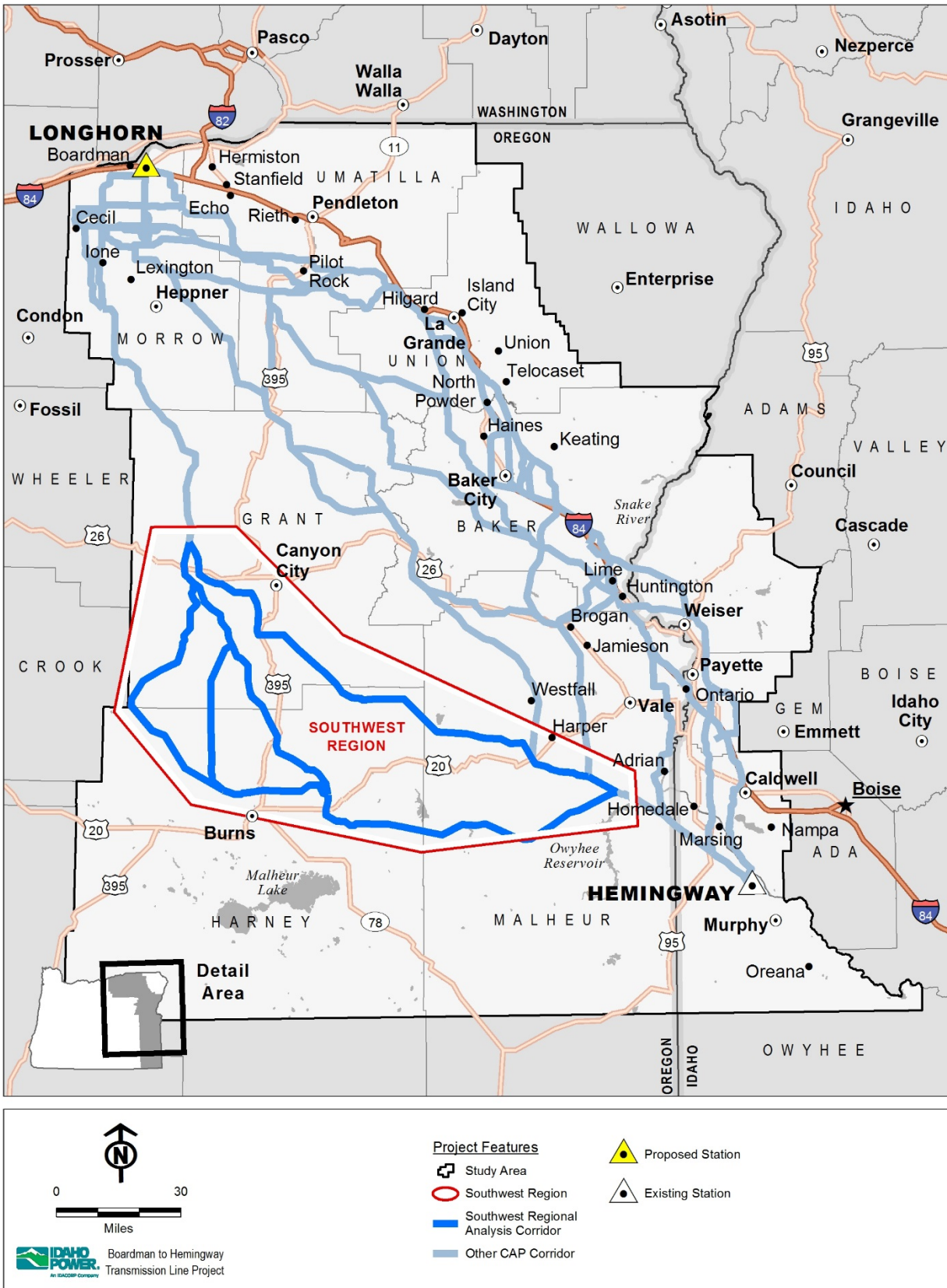
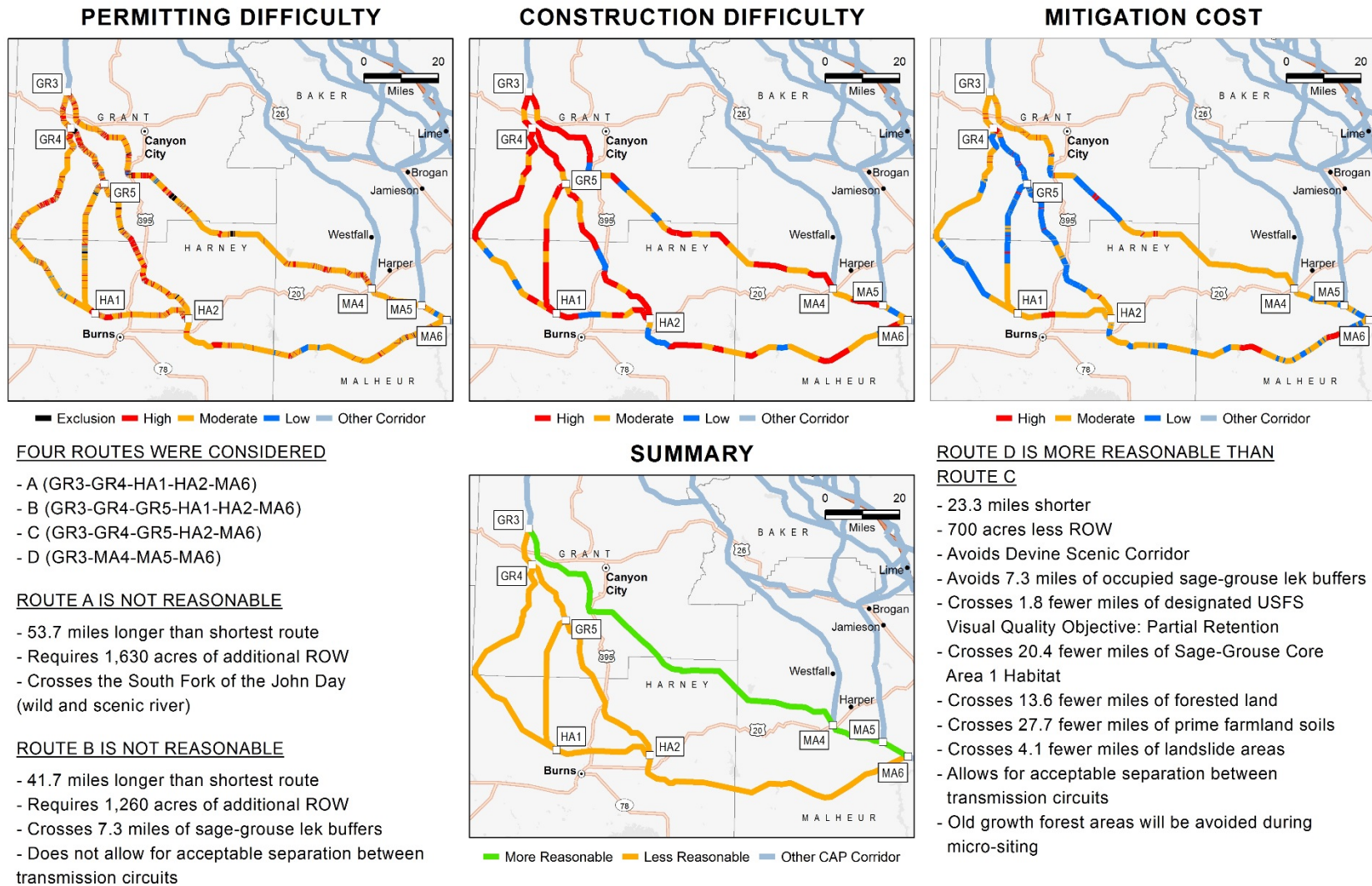

Figure B-11. Southwest Region Analysis



1 **Figure B-12. Permitting, Construction, and Mitigation Analysis (Southwest Region)**

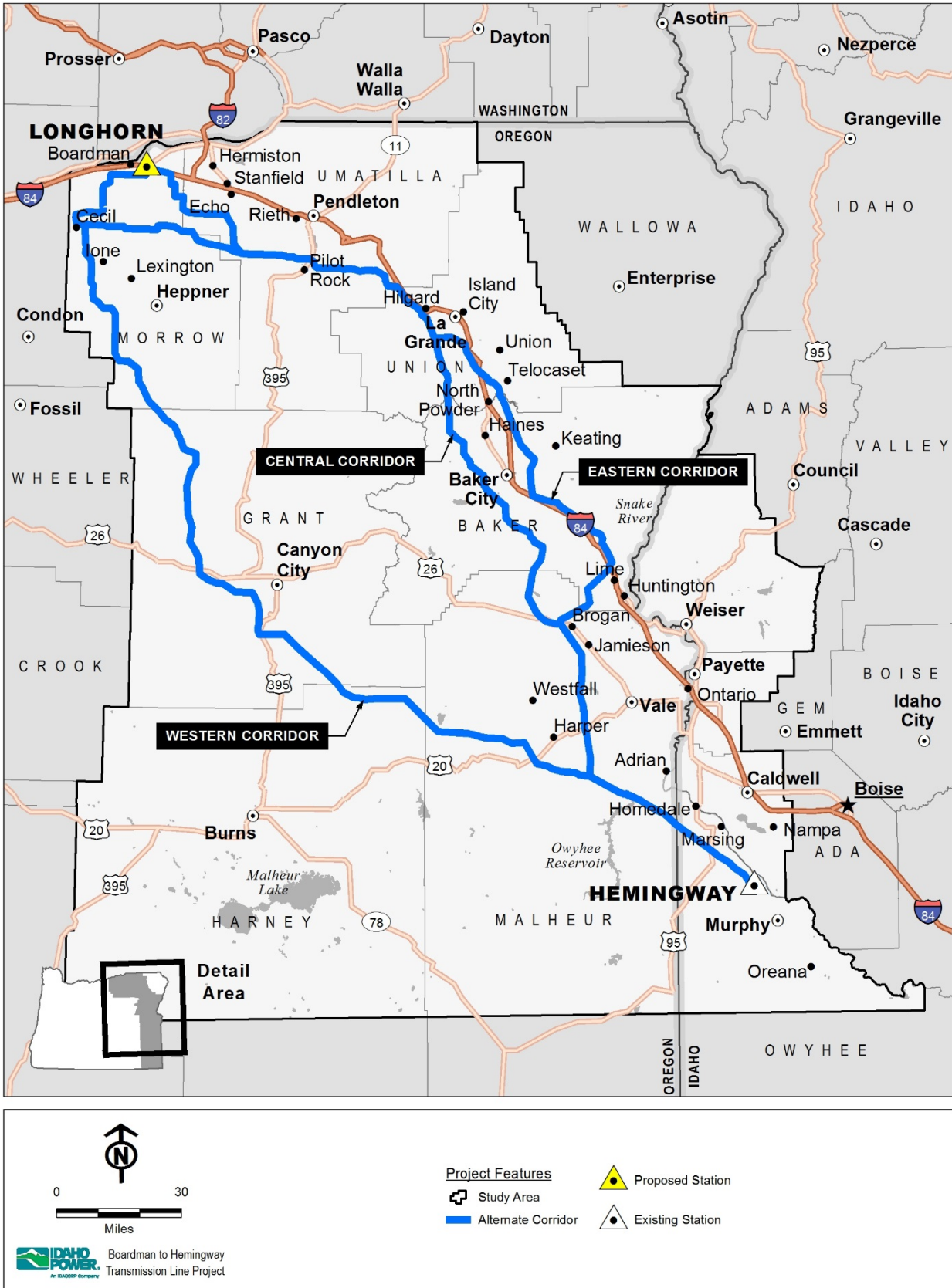

Figure B-13. Alternative Corridors

### 3.1.2.4 Analysis of Three Alternative Corridors

As shown on Figure B-13, IPC identified three alternative corridors—Eastern, Central, and Western. For detailed discussion of the analysis, see Attachment B-1.

As a result of the analysis of the three corridors, IPC selected the Eastern Corridor as the basis for its Proposed Corridor.<sup>10</sup> When compared to the Central and Western corridors, the Eastern Corridor:

- Would require over 35 fewer miles of new corridor,
- Would parallel existing utility corridors for over 50 miles more,
- Would require over 1,000 fewer acres of clearing,
- Would be significantly less difficult to construct, and
- Would avoid creating a new 30- to 45-mile utility corridor through one or more National Forests.

While it would avoid new impacts on rugged forest lands, the Eastern Corridor would cross approximately 75.8 more miles of EFU-zoned land than the Western Corridor, and 18.4 more miles than the Central Corridor. Compared to the Central Corridor, the Eastern Corridor would cross 33.1 fewer miles designated as high construction difficulty and 21.1 fewer miles designated high permitting difficulty and it would not require plan amendment to designate a utility corridor in the Wallowa-Whitman National Forest. The Western Corridor would have a similar degree of permitting difficulty as the Eastern Corridor, but would have required plan amendments for utility corridors crossing the Malheur and Wallowa-Whitman National Forests. The Western Corridor would also traverse 55.1 more miles designated high construction difficulty.

Table B-4 compares each corridor across all resource factors listed in Attachment B-3. The total of OAR 345-021-0010(1)(b)(D) factors encountered are categorized as more, less, or least reasonable when the corridors are compared to each other. In other words, the Eastern Corridor was the best corridor for avoiding impacts to 38 resources, the second best for another 19 resources, and the least reasonable for 11 resources. The results indicate an overall lower potential for resource impact for the Eastern Corridor. The results also clearly indicate that there was no single corridor that was the best choice for *all* of the resources; as contemplated by OAR 345-021-0010(1)(b)(D), IPC carefully considered and evaluated each corridor against the eight factors and selected the Eastern Corridor as the basis for the Proposed Corridor.

**Table B-4. Comparison of OAR 345-021-0010(1)(b)(D) Factors by Corridor**

<b>Resource Factor Encounters</b>	<b>Western Corridor</b>	<b>Central Corridor</b>	<b>Eastern Corridor</b>
More Reasonable	32	25	38
Less Reasonable	32	26	19
Least reasonable	13	11	11
No encounter	12	27	21
<b>Total Resource Factors</b>	<b>89</b>	<b>89</b>	<b>89</b>

Using the factors presented Tables B-4 and B-5, the Eastern Corridor was selected as the Proposed Corridor with the understanding that additional micrositing would be necessary to avoid and reduce potential impacts. The additional siting work that has been done since 2010 is

<sup>10</sup> Note that the Proposed Corridor differs from the Eastern Corridor in the Boardman area.

described in Section 3.1.3, 3.1.4, and 3.1.5 and in further detail in the 2012, 2015, and 2017 Supplemental Siting Studies (Attachments B-2, B-4, and B-6).

### 3.1.3 Corridor Selection Process Phase Two – September 2010 to February 2013

Having selected a Proposed Corridor for the Project, IPC submitted its Notice of Intent (NOI) to apply for a Site Certificate for the Project in July 2010. The ODOE held public informational meetings regarding IPC's Proposed Corridor in August 2010, and IPC prepared a Siting Study detailing the first phase of its Corridor Selection Process in August 2010 (Attachment B-1).

During the time between IPC's submittal of its July 2010 NOI and the 2010 Siting Study (Attachment B-1) and filing of the preliminary ASC (pASC) in February 2013, IPC engaged in extensive discussions with landowners and performed more detailed engineering and constructability analyses that suggested corridor adjustments and changes. In addition, IPC identified alternatives to the northern terminus of the Project. IPC proposed to remove approximately 4.8 miles of existing 138-kV line and build approximately 4.1 miles of 500-kV line on the ROW. In order to do this, IPC would have to rebuild approximately 5.0 miles of single-circuit 69-kV transmission line onto double-circuit 138/69-kV structures within the existing 69-kV ROW. An additional 0.3 mile of new 138-kV single-circuit transmission line would have to be built to tie the 138-kV part of the double-circuit line back to the existing 138-kV line.

These steps resulted in over 48 adjustments of the Proposed Corridor and alternative corridor segments, as well as identification of two alternative station locations. OAR 345-021-0010(1)(b)(D) required IPC to discuss reasons for selecting corridors not presented at the informational meetings described in OAR 345-015-0130. Table B-5 identifies changes and revised corridors developed after the informational meetings. Table B-5 also lists the reasons for the changes and their relationship to the eight siting factors identified in OAR 345-021-0010(1)(b)(D) (see additional discussion in Section 3.1.2 above, 3.1.4, and 3.1.5 and Attachment B-2, Appendix C for associated maps). The process leading to the selection of the 2012 Proposed Corridor and the alternative corridor segments for portions of the Proposed Corridor is described in Attachment B-2, 2012 Supplemental Siting Study.

**Table B-5. Proposed and Alternative Corridor Adjustments since Informational Meetings (August 2010)**

Map Label ID	Map Number Reference from Attachment B-2, Appendix C	Approximate Milepost (MP) Location relative to June 2012 Proposed and Alternative Corridors	IPC Corridor Change Description	IPC Basis for Corridor Change	Potential OAR 345-021-0010(1)(b)(D) Siting Factor
1	Map 1	Grassland Station – Proposed Corridor MP 8	Proposed Corridor shifted north to follow Boardman to Slatt Existing Line	Avoids crossing north edge of The Nature Conservancy Grassland Preserve with Washington ground squirrel (WAGS) colonies	ii
2	Map 1	Proposed Corridor MP 6.8	Added Horn Butte Station as potential Project termination and interconnection to Boardman to Slatt existing transmission line	Shortens overall length of transmission line and avoids WAGS colonies	ii



Map Label ID	Map Number Reference from Attachment B-2, Appendix C	Approximate Milepost (MP) Location relative to June 2012 Proposed and Alternative Corridors	IPC Corridor Change Description	IPC Basis for Corridor Change	Potential OAR 345-021-0010(1)(b)(D) Siting Factor
3	Map 1	Proposed Corridor MP 6.8-34.1	Added Horn Butte Alternative	Connect to Alternative Station	NA
4	Map 1	Proposed Corridor MP 12-18	Shifted Proposed Corridor to stay closer to Boardman Grasslands Preserve	Adjusted corridor per landowner discussion	ii
5	Map 1	Proposed Corridor MP 20-23	Shifted Proposed Corridor to stay on Property Boundary	Adjusted corridor per landowner discussion	NA
6	Map 1	Proposed Corridor MP 33.5-39	Proposed Corridor Centerline Adjustment	Landowner request to shift around proposed wind turbines	NA
7	Map 1-2	Proposed Corridor MP 39-43	Proposed Corridor Centerline Adjustment	Avoid pivot irrigation; property line offset adjustments; maximize structure offset distances, tower spotting analysis/engineering assessment to improve constructability	NA
8	Map 1-2	Grassland Substation – Proposed Corridor MP 56.5	Eliminated Segment of July 2010 NOI Proposed Corridor (Northern Approach to Grassland Station)	2011 surveys identified potential WAGS colonies (Category 1 habitat); alternative Longhorn Station would preclude need to have a northern corridor to the proposed Grassland Station	ii
9	Map 1	Longhorn Alternative MP 0	Added Longhorn Station as potential Project termination and interconnection to McNary to Coyote Springs existing transmission line	Alternative Longhorn Station would preclude need to have a northern corridor to the proposed Grassland Station	NA
10	Map 1	Longhorn Alternative MP 0-18.4	Added Longhorn Alternative	Connect to Alternative Station	NA
11	Map 2	Proposed Corridor MP 44-50	Proposed Corridor Centerline Adjustment	Engineering assessment to improve constructability	vii
12	Map 2	Proposed Corridor MP 51-56.5	Shifted Proposed Corridor to stay on north side of Slusher Canyon	Avoids crossing Slusher Canyon twice and stream crossings	i and vii

<b>Map Label ID</b>	<b>Map Number Reference from Attachment B-2, Appendix C</b>	<b>Approximate Milepost (MP) Location relative to June 2012 Proposed and Alternative Corridors</b>	<b>IPC Corridor Change Description</b>	<b>IPC Basis for Corridor Change</b>	<b>Potential OAR 345-021-0010(1)(b)(D) Siting Factor</b>
13	Map 2	Proposed Corridor MP 63-67	Proposed Corridor Centerline Adjustment	Engineering assessment to improve constructability	vii
14	Map 2	Proposed Corridor MP 68-70	Proposed Corridor Centerline Adjustment	Engineering assessment to improve constructability	vii
15	Map 2	Proposed Corridor MP 74-76	Proposed Corridor Centerline Adjustment	Engineering assessment to improve constructability	vii
16	Map 2-3	Proposed Corridor MP 78-85	Shifted Proposed Corridor South	Landowner request to avoid homes, avoids difficult terrain, less access roads, avoids access off of Indian Reservation	vii
17	Map 3	Proposed Corridor MP 86-91	Shifted Proposed Corridor North	Adjusted to avoid canyon crossings	vii
18	Map 3	Proposed Corridor MP 93-96.5	Proposed Corridor Centerline Adjustment	Better use of existing access roads, engineering assessment to improve constructability	vii
19	Map 3	Proposed Corridor MP 100-103	Proposed Corridor Centerline Adjustment	Avoid State Park, engineering assessment to improve tower locations	v
20	Map 3	Proposed Corridor MP 106-108.5	Proposed Corridor Centerline Adjustment	Adjust alignment to follow WECC offset criteria from existing lines	iii
21	Map 3	Proposed Corridor MP 109-116	Proposed Corridor shifted east ~3 miles	Adjusted line corridor to follow existing BPA line corridor and utilize existing access roads per landowner request, avoid adding access roads in timbered areas	iii
22	Map 3-4	Glass Hill MP 5 – Proposed MP 124	Eliminated portion of Glass Hill Alternative	Difficult terrain forced alternative to tie back into Proposed Corridor at earlier point	vii
23	Map 3-4	Proposed Corridor MP 116-126	Shifted Proposed Corridor Southwest	Avoid Oregon State University Research Forest, adjusted per landowner discussions, difficult terrain, engineering assessment to improve constructability	vii

<b>Map Label ID</b>	<b>Map Number Reference from Attachment B-2, Appendix C</b>	<b>Approximate Milepost (MP) Location relative to June 2012 Proposed and Alternative Corridors</b>	<b>IPC Corridor Change Description</b>	<b>IPC Basis for Corridor Change</b>	<b>Potential OAR 345-021-0010(1)(b)(D) Siting Factor</b>
24	Map 4	Proposed Corridor MP 126-130	Eliminated Clover Creek Valley Alternative	No environmental advantage to alternative which also requires two crossings of existing 230-kV line	NA
25	Map 4	Proposed Corridor MP 127-128	Proposed Corridor Centerline Adjustment	Avoid crossing ODOT gravel pit/blasting area	NA
26	Map 4	Proposed Corridor MP 130-134	Shifted Proposed Corridor North	landowner request to shift alignment to avoid potential new structure location	NA
27	Map 5	Proposed Corridor MP 151-152	Proposed Corridor Centerline Adjustment	Avoid crossing occupied Sage-grouse lek 2-mile buffers	ii
28	Map 5	Proposed Corridor MP 154-157	Shifted Proposed Corridor East	Adjusted corridor to reduce visibility from NHOTIC	vi
29	Map 5	Proposed Corridor MP 154-170	Eliminated Virtue Flat Alternative	Alternative could not be sited to avoid occupied Sage-grouse lek 2-mile buffers in effect at time of elimination	ii
30	Map 5	Proposed Corridor MP 158.5-164	Proposed Corridor Centerline Adjustment	Engineering assessment to improve constructability	vii
31	Map 5	Proposed Corridor MP 165-168	Proposed Corridor Centerline Adjustment	Improve crossing of 69kV and better utilize existing 138-kV corridor	iii
32	Map 5-6	Proposed Corridor MP 168-170	Shifted Proposed Corridor South	Landowner request to shift alignment farther from existing residence	NA
33	Map 6	Proposed Corridor MP 180-183	Proposed Corridor Centerline Adjustment	Adjusted per landowner discussion concerning avoidance of natural amphitheater	NA
34	Map 6	Proposed Corridor MP 186-187.5	Proposed Corridor Centerline Adjustment	Adjusted corridor per landowner discussion	NA
35	Map 6	Proposed Corridor MP 186-191	Eliminated Weatherby Alternative	Difficult terrain, Proposed 138/69-kV Rebuild a better option	iii and vii

Map Label ID	Map Number Reference from Attachment B-2, Appendix C	Approximate Milepost (MP) Location relative to June 2012 Proposed and Alternative Corridors	IPC Corridor Change Description	IPC Basis for Corridor Change	Potential OAR 345-021-0010(1)(b)(D) Siting Factor
36	Map 6	Proposed Corridor MP 188-193	Added Proposed Double-Circuit 138/69-kV Rebuild. 500-kV line to be built within existing 138-kV ROW; existing 138-kV and 69-kV lines to be rebuilt as double circuit structures in existing 69-kV ROW	Difficult terrain	vii
37	Map 7	Proposed Corridor MP 205.5-216	Shifted Proposed Corridor North and West	Avoid crossing occupied Sage-grouse lek 2-mile buffers, adjusted per landowner discussions, engineering assessment to improve constructability across canyon	ii and vii
38	Map 7-8	Proposed Corridor MP 216-229.5	Shifted Proposed Corridor West	Avoid crossing occupied sage-grouse lek 2-mile buffer identified in 2011 survey season	ii
39	Map 7-8	Proposed Corridor MP 199.5-229.5	Added Willow Creek Alternative	Avoid crossing occupied Trail Gulch sage-grouse lek 2-mile buffer	ii
40	Map 8	Proposed Corridor MP 233-238	Shifted Proposed Corridor West	Engineering assessment to improve constructability	vii
41	Map 8	Proposed Corridor MP 238-240	Proposed Corridor Realignment across Malheur River	Avoid cultural resources and golden eagle nest found during 2011 surveys	vi
42	Map 8-9	Proposed Corridor MP 240-273	Shifted Proposed Corridor East	Avoid areas inventoried as having wilderness characteristics, avoid ACEC, follow Vale District Utility Corridor	iii and v
43	Map 8-9	Proposed Corridor MP 243-272	Added Malheur S Alternative	Avoid areas inventoried as having wilderness characteristics, minimizes ACEC crossing	v
44	Map 8-9	Proposed MP 245-252	Added Double Mountain Alternative	Avoid private land/stay on BLM-managed land	NA
45	Map 9	South of Malheur S Alternative MP 18-23	Eliminated Owyhee River Below Dam Alternative	Relocation of Proposed Corridor – no need for alternative	NA
46	Map 10	Proposed Corridor MP 275-277	Shifted Proposed Corridor South	Avoid crossing EFU-zoned land	viii

Map Label ID	Map Number Reference from Attachment B-2, Appendix C	Approximate Milepost (MP) Location relative to June 2012 Proposed and Alternative Corridors	IPC Corridor Change Description	IPC Basis for Corridor Change	Potential OAR 345-021-0010(1)(b)(D) Siting Factor
47	Map 10	Proposed Corridor MP 281-285	Shifted Proposed Corridor South	Avoid private land, follow WECC offset criteria from existing lines	iii
48	Map 10	Proposed Corridor MP 286-289.5	Shifted Proposed Corridor North	Idaho Department of Lands request to reduce offset to existing 500-kV line	iii

<sup>1</sup>The adjustments that occurred in the state of Idaho are not included in this table.

ACEC – Area of Critical Environmental Concern; BPA – Bonneville Power Administration; EFU – Exclusive Farm Use; NA – Not Applicable; NHOTIC – National Historic Oregon Trail Interpretive Center; ODOT – Oregon Department of Transportation; WECC – Western Electricity Coordinating Council

### 3.1.4 Corridor Selection Process Phase Three – February 2013 to May 2016

After filing the pASC for the Project in 2013, IPC identified the need to perform additional analysis and revision to the Project, resulting in some macro (major) and micro (minor) route adjustments. The macro changes included the addition of alternatives and the determination not to carry some alternative and stations forward into the 2017 Amended pASC as shown in Table B-6. The micro changes included making minor line and road location adjustments to avoid sensitive resources, reduce redundancy of project features, and improve the preliminary engineering design.

**Table B-6. Proposed and Alternative Corridor Adjustments (macro changes) since Preliminary Application for Site Certificate (February 2013)**

Map Number Reference from Attachment B-4	IPC Corridor Change Description	IPC Basis for Corridor Change	Potential OAR 345-021-0010(1)(b)(D) Siting Factor
Figure 3.1-1 Morrow County	Proposed Station and Proposed Corridor changed due to cancellation of the Portland General Electric's Cascade Crossing transmission line.	Longhorn Station is IPC's proposed station because Grassland and Horn Butte do not provide an adequate electrical connection to meet the needs of the Project. The West of Bombing Range Road is the proposed corridor due to Longhorn Station being the proposed station. Minimizes impacts to agricultural and WAGS and other existing infrastructure.	ii
Figure 3.1-2 Union County	Glass Hill Alternative Corridor Segment not carried forward.	Glass Hill Alternative Corridor Segment was not carried forward by BLM as the agency preferred route.	ii
Figure 3.1-3 Baker County	Virtue Flat and Durkee Alternative not carried forward.	Virtue Flat and Durkee alternatives were not carried forward by BLM as the agency preferred routes due to sage-grouse issues.	ii

Map Number Reference from Attachment B-4	IPC Corridor Change Description	IPC Basis for Corridor Change	Potential OAR 345-021-0010(1)(b)(D) Siting Factor
Figure 3.1-4 Malheur County	Brogan 2012 Proposed Corridor, Willow Creek, Malheur A and Malheur S Alternatives not carried forward.	Brogan 2012, Willow Creek, Malheur A and Malheur S alternatives were not carried forward by BLM as the agency preferred route.	ii

<sup>1</sup> The adjustments that occurred in the state of Idaho are not included in this table.

WAGS – Washington ground squirrel

The 2015 Supplemental Siting Study (Attachment B-4) explains why IPC was required to modify the Project following filing of its 2013 pASC, as identified below:

- 1) BLM’s identification of a preliminary preferred route that included several segments not analyzed in the pASC:** In May 2013, BLM identified the preliminary preferred alternative for the Project in advance of public release of the Draft Environmental Impact Statement (EIS). BLM selected a preliminary preferred alternative that resulted in the lowest impact on the natural, human, and cultural environment that best protects, preserves, and enhances historic, cultural, and natural resources.

BLM released the Draft EIS in December 2014 identifying the agency preferred alternative as the same as the environmentally preferred alternative alignment. BLM selected the agency preferred alternative that it believes would fulfill the statutory mission and responsibilities of the agencies while giving consideration to economic, environmental, technical, and other considerations. In addition to the key resources listed above in selecting the environmentally preferred alternative, BLM also identified the following criteria for consideration while identifying the recommended agency preferred alternative:

- Land Use (ACEC values, lands with wilderness characteristics, and wild and scenic suitable rivers)
- Agriculture
- Use of corridors (designated corridors including the WWE corridor, the BLM Vale District corridor, and USFS corridors; proximity to existing roads including I-84; parallel to and in proximity of existing transmission lines)
- Socioeconomics
- Technical and other considerations (military operations, constructability, and Resource Management Plan and USFS plan conformance)

- 2) Formal guidance from ODFW regarding its interpretation of its Habitat Mitigation policy and sage-grouse guidance:** IPC received a letter from ODFW in August 2013 stating that the ODFW Habitat Mitigation Policy (OAR 635-415-0025) does not draw a distinction between direct and indirect impacts to Category 1 habitat. The letter also stated that ODFW understands that IPC may be faced with rerouting the Project based on their guidance. Without a change in both BLM and ODFW’s current positions on sage-grouse habitat, it is highly unlikely that either the federal or state agencies involved will authorize the Virtue Flats and Durkee Alternative Corridor Segments of the Proposed Corridor. These segments were therefore not analyzed in the Amended pASC.

- 3) Further coordination with the Bonneville Power Administration (BPA), PacifiCorp, and other utilities in Boardman area:** In order for the Project to meet its objective of adding approximately 1,000 MW of bi-directional capacity between the Pacific Northwest

and Intermountain West regions, the point of interconnection at the northern terminus must provide sufficient capacity to: 1) transfer an additional 1,050 MW of power from the BPA 500-kV transmission system in the Pacific Northwest west-to-east across the Idaho-Northwest transmission path; 2) transfer an additional 1,000 MW of power east-to-west across the Idaho-Northwest transmission path; and 3) allow for actual power flows on the B2H line of up to approximately 1,500 MW, accounting for variations in actual power flows of the various transmission lines comprising the Idaho-Northwest transmission path.

When IPC began the federal permitting process for B2H in 2007, other transmission development projects were being proposed in the Pacific Northwest that influenced Idaho Power's northern terminus location options for the Project. Portland General Electric's (PGE) Cascade Crossing 500-kV project was of particular note. In fact, in 2008, IPC and PGE executed a Memorandum of Understanding concerning Boardman area transmission development, with the intent of sharing development plans and developing facilities collaboratively to assist each company in fulfilling their respective service and system reliability obligations. The proposed Grassland Station was contemplated as an interconnection point between the two projects that could help each company with their respective project objectives. In IPC's 2013 pASC, the proposed termination point in the Boardman area was the Grassland Station.

However, since the 2013 pASC, the transmission development landscape has changed. Several of the development projects under consideration during the time of original application have subsequently been cancelled. Notably, in 2013, PGE indefinitely suspended the Cascade Crossing project. Even though the Grassland Station has been developed in connection with PGE's Carty Generating station, with the cancellation of the Cascade Crossing project, additional 500-kV transmission infrastructure would have been required to provide connection into the transmission grid to meet the needs of the Project. Therefore, the Grassland Station will not be analyzed in the ASC as a termination point. Rather, IPC is proposing to terminate the Project at the Longhorn Station.

- 4) Continued engineering to minimize impacts and improve design:** Since submittal of the 2012 Supplemental Siting Study as part of the pASC, IPC has performed more detailed engineering analyses that resulted in corridor adjustments and changes to avoid sensitive resources as well as improve constructability (see Attachment B-4, 2015 Supplemental Siting Study).

### **3.1.5 Corridor Selection Process Phase Four – May 2016 to Present**

In March 2016, the BLM requested additional input from stakeholders on the alternatives being considered in the NEPA process. BLM took the information provided by the stakeholders and developed a revised Agency Preferred Alternative. The revised BLM Agency Preferred Alternative resulted in 147.4 miles of route modifications in Oregon to the IPC Proposed Route as presented in the 2017 Amended pASC and this ASC (see Attachment B-6, 2017 Supplemental Siting Study). The majority of the route modifications occurred in Morrow, Umatilla, Union, and Baker counties (Table B-7).

**Table B-7. Miles of Route Modifications as a Result of BLM Agency Preferred Alternative**

County	Miles of Route Modifications
Morrow	31.4
Umatilla	30.5
Union	32.3
Baker	47.2
Malheur	6.0
<b>Total</b>	<b>147.4</b>

IPC made minor changes to the sections of the Proposed Route that were submitted in the 2017 Amended pASC and this ASC that were not eliminated by the new BLM Agency Preferred Alternative. These included minor line and road location adjustments as well as adjustments to avoid sensitive resources, reduce redundancy of project features, and improve the preliminary engineering design. In addition, in coordination with permitting partners PacifiCorp and BPA and other stakeholders, IPC also added two alternatives in Morrow County and one alternative in Union County.

### 3.1.6 Analysis of Factors from OAR 345-021-0010(1)(b)(D)(i)-(viii)

OAR 345-021-0010(1)(b)(D): In the assessment, the applicant shall evaluate the corridor adjustments the Department has described in the project order, if any. The applicant may select any corridor for analysis in the application and may select more than one corridor. However, if the applicant selects a new corridor, then the applicant must explain why the applicant did not present the new corridor for comment at an informational meeting under OAR 345-015-0130. In the assessment, the applicant shall discuss the reasons for selecting the corridor(s), based upon evaluation of the following factors:

- (i) Least disturbance to streams, rivers and wetlands during construction.
- (ii) Least percentage of the total length of the pipeline or transmission line that would be located within areas of Habitat Category 1, as described by the Oregon Department of Fish and Wildlife;
- (iii) Greatest percentage of the total length of the pipeline or transmission line that would be located within or adjacent to public roads and existing pipeline or transmission line rights-of-way.
- (iv) Least percentage of the total length of the pipeline or transmission line that would be located within lands that require zone changes, variances or exceptions.
- (v) Least percentage of the total length of the pipeline or transmission line that would be located in a protected area as described in OAR 345-022-0040.
- (vi) Least disturbance to areas where historical, cultural or archaeological resources are likely to exist.
- (vii) Greatest percentage of the total length of the pipeline or transmission line that would be located to avoid seismic, geological and soils hazards.
- (viii) Least percentage of the total length of the pipeline or transmission line that would be located within lands zoned for exclusive farm use.

The following section describes IPC's reasons for selecting the Proposed Corridor, based upon evaluation of the factors identified in OAR 345-021-0010(1)(b)(D). It is important to note that these



factors do not comprise an EFSC siting standard and IPC is not required to satisfy these factors to meet any EFSC standard; rather, the rule simply requires that IPC discuss the factors in the application. In other words, consideration of the factors in a corridor selection assessment is best viewed as a process and informational requirement, not a substantive requirement or standard.

As described in earlier sections of this Exhibit, the corridor selection process to move from a two-state, 11-county study area comprising over 31,000 square miles to 3,000 miles of preliminary corridors in 2010, to selection of a Proposed Corridor in 2012, to modification of that Proposed Corridor based on input from the BLM and other new developments in 2015 and 2016, has been a complex process with extensive public and agency input. From the beginning of the process, IPC has employed the eight factors identified in OAR 345-021-0010(1)(b)(D) to filter through the various alternatives at an increasing level of detail. In the initial phase, more than 225 constraints to, and opportunities for, siting were identified including 124 that were directly related to the eight factors discussed below (see Tables B-2 and B-3). Using these constraints and opportunities and working with the local citizens, over 3,000 miles of alternative corridor were identified for further analysis.

Each alternative was again reviewed to improve the ability to permit and construct each corridor and corridor segment. Again the eight factors were applied to refine the corridors. In particular, IPC used aerial photography to identify and avoid, where practical, irrigation pivots, houses, barns, private runways, other structures (i.e., wind turbines), and land use features. The corridors were adjusted using topographic maps to avoid or minimize distance across very steep slopes and other physical features (factor vii) less desirable for transmission line construction and operation. Finally, the corridors were again checked against the constraint and opportunity GIS database to avoid, where possible, exclusion areas and areas of high permitting difficulty such as potential ODFW Category 1 habitats (factor ii). As a result of this analysis, the miles of alternative corridor still under consideration were reduced to about 2,000.

The alternative corridors were then grouped into 14 regions (see Figure B-10) and evaluated on the basis of permitting difficulty, construction difficulty and mitigation costs (see example, Figure B-12). Using the constraint database, which included the eight siting factors, the alternatives were reviewed to determine the most reasonable corridor within each region.

The most reasonable corridor segments from each region were combined to form three complete corridors spanning from the Boardman area to the Hemingway Substation. These three corridors were evaluated against the constraint database. This analysis resulted in a recommendation of the Eastern Corridor for reasons such as use of existing utility and transportation corridors for 50 additional miles (factor iii), crossing 20 fewer miles of 25 percent slopes (factor vii), and crossing 38 fewer special status streams (factor i).

After IPC submitted its 2010 NOI, it continued its siting process to further reduce potential impacts, eliminate some alternative corridor segments, and add several more substantial alternative corridor segments. These changes occurred as a result of extensive field studies, environmental analysis to better define areas of impact, and more detailed engineering studies to better define construction and operation requirements. The changes are documented in Attachment B-1, 2010 Siting Study, and Attachment B-2, 2012 Supplemental Siting Study. As a result, alignments have been shifted and access roads and structure sites have been moved to avoid or reduce impacts to the resources, including but not limited to those relevant to the eight factors.

Following IPC's submittal of a pASC in 2013, the third phase of Project siting occurred. Again during this phase, IPC undertook significant evaluation of resources and made many changes to the Project location, both macro and micro, to avoid and minimize impacts to resources

identified by one or more of the eight factors in OAR 345-021-0010(1)(b)(D). This third phase of siting is documented in Attachment B-4, 2015 Supplemental Siting Study.

In 2016, the fourth phase of Project siting occurred with the BLM's development of a revised Agency Preferred Alternative. The BLM refined the Agency Preferred Alternative based on input from public comments received on the Draft EIS, with IPC providing input on the eight factors in OAR 345-021-0010(1)(b)(D). This fourth phase of siting is documented in Attachment B-6, 2017 Supplemental Siting Study.

As described below, IPC has carefully considered and weighed the eight factors in OAR 345-021-0010(1)(b)(D) at both the macro- and the micro-siting levels.

**(i) Least disturbance to streams, rivers and wetlands during construction.** IPC has designed the Project to avoid impacts to streams, rivers, and wetlands to the maximum extent practicable. Streams, rivers, and wetlands have been considered in the siting and evaluation process since the initiation of siting at both the macro- and micro-siting level. As shown in Attachment B-3, six different categories of Special Status streams and National Wetland Inventory wetlands were used in the evaluation of the Eastern, Central, and Western corridors. In Phase One of siting the Project, IPC determined that the Eastern Corridor would cross 8 Special Status streams and 0.7 mile of wetland, compared to 13 crossings and 0.7 mile for the Central Corridor, and 46 crossings and 0.4 mile for the Western Corridor. Among those three corridors, the Eastern Corridor would result in the least disturbance to these resources.

During Phase Two of the siting process, in 2011 and 2012, IPC performed stream, river, and wetland mapping and delineation surveys of the proposed and alternative corridors. Based upon these data, adjustments were made to the proposed facilities to avoid or minimize project impacts to stream, river, and wetland resources.

During Phase Three and Phase Four of the siting process, in 2013, 2014, and 2016, IPC performed additional stream, river, and wetland mapping and delineation surveys of new alternative corridors. The results of these surveys were used to modify the location of proposed facilities to avoid or minimize impacts to stream, river, and wetland resources along these alternative corridors.

**(ii) Least percentage of total length of pipeline or transmission line that would be located within areas of Habitat Category 1, as described by the Oregon Department of Fish and Wildlife.** Category 1 habitat has been an important factor in IPC's evaluation and siting of the Project, and IPC has avoided impacts to known Category 1 habitat to the maximum extent practicable. Nonetheless, the Project area includes potential Category 1 habitat for Washington ground squirrels (WAGS) and greater sage-grouse (sage-grouse).

Category 1 WAGS habitat occurs within the Project Site Boundary near NWSTF Boardman. The portion of the Project within WAGS Category 1 habitat consists of the removal of the existing 69-kV transmission line along the southeastern boundary of NWSTF Boardman. Ground-disturbing activities will be temporary and will result in the removal of the 69-kV H-frame structures. Removal of the 69-kV H-frame structures will eliminate an existing raptor perching opportunity from which WAGS hunting could occur. IPC will work with ODFW to determine appropriate timing and methods for the removal of the 69-kV transmission line that will result in the least potential impact to WAGS and WAGS Category 1 habitat.

Designing the Project to avoid impacts to Category 1 sage-grouse habitat has been extremely challenging, in large part because of the dynamic and evolving nature of Oregon's sage-grouse habitat protection policy. In selecting and finalizing its 2010 Proposed Corridor, IPC based its efforts to avoid Category 1 sage-grouse habitat on ODFW guidance that Category 1 sage-grouse habitat comprised all habitat within 2 miles of leks, unless site-specific habitat conditions,

terrain, or existing man-made features potentially would reduce the category level. Consequently, the 2010 Proposed Corridor avoided most of the many 2-mile lek buffers in the Project vicinity.

In October 2012, IPC was advised that ODOE and ODFW determined that ODFW's core area approach to categorizing sage-grouse habitat must be applied to the Project, as set forth in the *Greater Sage-Grouse Conservation Assessment and Strategy for Oregon: A Plan to Maintain and Enhance Populations and Habitat* (ODFW 2011), referred to hereafter as the "2011 Strategy." Under the 2011 Strategy, ODFW designated "core areas" of sage-grouse habitat. ODFW recommends that all mapped core areas be identified as Category 1 habitat, subject to site-specific analysis and possible recategorization as Category 2 based on actual habitat conditions (degraded habitat, existing infrastructure or other disturbances, etc.). Consequently, the Proposed Corridor in IPC's 2013 pASC did not entirely avoid Category 1 sage-grouse habitat. To address this issue, IPC worked with ODFW to determine the precise extent of Category 1 sage-grouse habitat within the Site Boundary, and made every effort to micro-site to achieve the least disturbance of Category 1 habitat. Concurrently with IPC's siting efforts, BLM also engaged in siting work that resulted in its development of two new alternatives designed to avoid sage-grouse habitat, and identification of preliminary preferred alternatives that differed from IPC's 2012 proposed corridor.

In July 2015, the Oregon Fish and Wildlife Commission adopted new mitigation policies for addressing impacts to sage-grouse habitat (see OAR 635-140-000, -0002, -0010, -0015, and -0025). The new policies provide mitigation measures for avoiding and minimizing sage-grouse habitat impacts, and compensating for unavoidable impacts (see OAR 635-140-0025(2)). Then Governor Brown ordered all state agencies to update by July 1, 2015, their regulatory programs to be consistent with the new ODFW sage-grouse mitigation policies (see Executive Order No. 15-18). Accordingly, the new policies will dictate the Project's sage-grouse mitigation requirements and the Fish and Wildlife Habitat Mitigation Policy (OAR 635-415-0000) habitat categories (e.g., Category 1 habitat) will no longer apply to sage-grouse. Importantly, on October 19, 2015, ODFW filed a temporary rule exempting pending EFSC applications such as this Project from the avoidance and certain minimization provisions of ODFW's new sage-grouse policies (see OAR 635-415-0025(7)).

Regardless of the exemption, the history of the Project demonstrates that IPC—in response to ODFW and BLM input—has developed routes and changed the Project numerous times to avoid and minimize impacts to sage-grouse habitat. While the Proposed Corridor will impact some sage-grouse habitat, there is no reasonable alternative location that would avoid the habitat, and the public benefits of the Project outweigh the adverse effects on the same.

As illustrated by IPC's diligent siting efforts during all three phases of siting, IPC selected the Proposed Corridor based on careful consideration of the extent to which it achieves the least percentage of total length of transmission line located within areas of Habitat Category 1, as described by the ODFW.

**(iii) Greatest percentage of the total length of the transmission line that would be located within or adjacent to public roads, as defined in ORS 368.001 and existing transmission line rights-of-way.** IPC has designed the Project to be located adjacent to public roads and existing transmission line ROWs to the maximum extent practicable. The Project is too large to be entirely located within existing public ROWs; however, IPC has treated existing public roads and utility ROWs as siting opportunities, as reflected in the Exhibit B, Attachment B-2, 2012 Supplemental Siting Study. As a result, the Proposed Corridor is located parallel to over 100 miles of public roads (I-84) and/or existing transmission lines. This is considerably more than the other corridors under consideration, which was a significant factor in IPC's selection of the Proposed Corridor.

Since IPC submitted its NOI, it has considered additional locations in which the Project could be located adjacent to existing roads and utility ROWs. IPC has proposed to remove 12 miles of existing 69-kV transmission line and use its existing 90-foot ROW for the 500-kV transmission line. The existing 90-foot 69-kV ROW will not be widened. IPC has proposed to rebuild 0.9 mile of a 230-kV transmission line into a new 125-foot ROW. The existing 230-kV ROW will be widened to 250 feet to accommodate placement of the 500-kV transmission line. IPC has also proposed to rebuild approximately 1.1 miles of an existing 138-kV line into a new 100-foot ROW, and use approximately 0.8 mile of this ROW for the 500-kV transmission line. The existing 100-foot 138-kV ROW will be widened to 250 feet for 0.8 mile to accommodate placement of the 500-kV transmission line. Proposed ROW widths are discussed in Section 3.5.2.

**(iv) Least percentage of the total length of transmission line would be located within lands that would require zone changes, variances or exceptions.** IPC has, to the maximum extent practicable, designed the Project to avoid lands for which a zone change, variance, or land use exception would be required. Much of the Project is located on EFU-zoned lands, a zone for which a transmission line is a permitted use if siting the line on EFU is “necessary” for the Project (ORS 215.283; ORS 215.275). However, as described in detail in Exhibit K, Section 7.0, the Project will require a Goal 4 exception for the portions of the Site Boundary located in Goal 4 forest lands in Umatilla and Union counties. For most of the Project, no zone change, variance, or exception is required.

**(v) Least percentage of the length of the pipeline or transmission line that would be located in a protected area as described in OAR 345-022-0040.** As described in detail in Exhibit L, Section 3.3, IPC’s Proposed Corridor was developed to avoid protected areas to the maximum extent practicable. There are approximately 82 protected areas within 20 miles of the Site Boundary, and all were considered constraints during the siting process. The Proposed Corridor crosses the corner of the Blue Mountain Forest State Scenic Corridor. This crossing is discussed further in Exhibit L, Section 3.5, and Exhibit R, Section 3.3. The fact that the Proposed Corridor avoids 81 of the 82 protected areas within the study area was a strong factor in support of its selection.

**(vi) Least disturbance to areas where historical, cultural or archaeological resources are likely to exist.** To the extent possible, IPC has designed the Project to avoid disturbance to areas where historical, cultural, or archaeological resources were known or likely to exist. Historic, cultural, and archeological resources were important considerations in corridor selection and, where possible, these resources were avoided during the siting process. Five cultural resource factors were considered in evaluating the three corridors at the macro level: As shown in Attachment B-3, these included the “Burns District Archaeological Site,” locations “within 1,200 foot Historic Trail Buffer,” “within .5 mi of a National Register Historic Place Buffer,” crossings of “Intact Oregon Trail Segments”, and “Oregon Trail Brochure – Trail rut” Only locations “within 1,200 foot of historic trail buffer” show a significant difference in the corridor analysis. For this category, the Eastern Corridor is within 1,200 feet of a historic trail for about 4.5 miles more than the Central and Western corridors. Detailed field studies have been completed to identify additional historical, cultural, or archaeological resources. When these resources cannot be avoided, impacts can be addressed by spanning these resources, separating structures by up to 1,500 feet or more, and by other means such as relocating access roads and construction areas. When avoidance does not eliminate the potential for disturbance, treatment plans can be developed to mitigate impacts.

During Phase Two of the siting process, IPC performed cultural resource surveys of the proposed and alternative corridors. Based upon these data, adjustments were made to the proposed facilities to avoid or minimize impacts to historic, cultural, and archeological

resources. Exhibit S, Section 3.3 provides additional information on the avoidance of impact to these resources.

During Phase Three and Phase Four, IPC performed additional cultural resource surveys of new alternative corridors. The results of these surveys were used to modify the location of proposed facilities to avoid or minimize impacts to historic, cultural, and archeological resources along these alternative corridors. Exhibit S, Section 3.3 provides additional information on the avoidance of impact to these resources.

**(vii) Greatest percentage of the total length the transmission line would be located to avoid seismic, geologic and soils hazards.** As described in detail in Section 3.3 of both Exhibits H and I, IPC has designed the Proposed Corridor to avoid seismic, geologic, and soils hazards to the maximum extent practicable. In the corridor selection process there were 17 factors in the list of constraints associated with seismic, geologic, and soils hazards that were used to evaluate the proposed and alternative corridors (see Attachment B-3). Of these factors, four were encountered along the three final corridors considered at the macro level. For slopes greater than 35 percent, high erosion hazard, and landslides, the steeper terrain along the Central and Western corridors indicated a higher potential for impact. The Eastern Corridor showed a higher potential to be near fault lines. As part of micrositing, these factors have been considered in the siting of transmission structures, access roads, and other Project features to minimize seismic, geologic, and soils hazards. Prior to construction, a comprehensive geotechnical investigation will be conducted to further reduce such potential impacts.

**(viii) Least percentage of the length of the transmission line located within lands zoned as exclusive farm use.** As described in detail in Exhibit K, Sections 4.1 and 6.3, IPC has attempted to design the Proposed Corridor to avoid lands zoned EFU to the maximum extent practicable. However, as illustrated by Figure B-4 and in Exhibit K, Figure K-3 any corridor that meets the Project's stated purpose—connecting IPC's existing Hemingway Substation to the Longhorn Station near Boardman, Oregon—cannot avoid crossing lands zoned EFU. The predominance of land zoned EFU in the study area (approximately 77 percent in Oregon) makes it absolutely necessary for the Project to “cross land in one or more areas zoned for EFU in order to achieve a reasonably direct route.” Accordingly, as discussed in detail in Exhibit K, the lack of available non-EFU land is the primary reason that the Project is “locationally dependent” on EFU zones, and is therefore a “utility facility necessary for public service” within the meaning of ORS 215.275. Despite IPC's best efforts to design the Project to avoid EFU-zoned lands, the entire length of the Proposed Corridor in Oregon is zoned EFU or a hybrid farm-forest zone.

Nonetheless, and although not required by ORS 215.275, IPC's extensive siting process has prioritized avoiding impacts to irrigated and other high value farmland to the maximum extent possible.<sup>11</sup> As explained in detail in Attachment B-1, Appendix C, IPC identified irrigated farmland as a “high avoidance” constraint throughout its siting process. In order to both achieve the Project's objective and avoid impacts to the many protected resources in the study area (see discussion of factors i through vii), IPC's 2010 Proposed Corridor crossed 17.8 miles of irrigated farmland. During micrositing, IPC continued to refine its Proposed Corridor in response to site-specific information and landowner requests; these micrositing changes included

---

<sup>11</sup> IPC's efforts to minimize impacts to EFU-zoned lands are driven by its own siting objectives as well as OAR 345-021-0010(1)(b)(D)(viii), but not ORS 215.275. ORS 215.275 does not require a “utility facility necessary for public service” that is locationally dependent on EFU to further demonstrate that it has minimized impacts on EFU land. See *WKN Chopin LLC v. Umatilla County*, LUBA Opinion No. 2012-016 at page 17 (“ORS 215.275(2) requires consideration of alternatives to siting the proposed facility ‘in an exclusive farm use zone.’ There are no such alternatives in this case. ORS 215.275 simply does not require that an applicant proceed through additional inquiries that are designed to minimize impacts on EFU-zoned land, where non-EFU-zoned alternatives are not available.”)

changes to minimize impacts to irrigated agriculture and agricultural operations. The Project currently crosses 6.6 miles of irrigated farmland. Additionally, in Exhibit K, Section 4.1.2, IPC provides the six factor analysis required by ORS 215.275(2).

In an effort to further reduce impacts to agricultural land, IPC developed the West of Bombing Range Road Alternative (see Attachment B-4, 2015 Supplemental Siting Study). Working with BPA, IPC developed the West of Bombing Range Road Alternative, which takes advantage of an existing 69-kV transmission line ROW and was sited to minimize impacts to agriculture and NWSTF Boardman flight operations, and reduce impacts to WAGS habitat (through micrositing). The West of Bombing Range Road Alternative significantly reduced, but did not completely eliminate, impacts to agricultural lands and operations.

After completion of the corridor selection process, IPC performed more detailed engineering analyses of the Proposed Corridor that resulted in adjustments and changes to avoid sensitive resources as well as improve constructability. With the completion of these adjustments to the Proposed Corridor, IPC developed the Proposed Route that is analyzed in the ASC.

### 3.2 Description of Proposed Facility

OAR 345-021-0010(1)(b)(A) requires a description of the Project. The following section describes the transmission, station, communication, and related or supporting facilities proposed for this Project. Project dimensions are listed in Section 3.4, Table B-13. Detailed maps showing temporary and permanent facility locations are contained in Exhibit C, Attachments C-1 and C-2.

The information herein and in subsequent sections is based on the preliminary design that has been completed. The exact quantity, size, description, distance between, and placement of the structures and components will depend on the final detailed design of the transmission line, which is influenced by the terrain, land use, and economics.

#### 3.2.1 Electrical Generating Capacity

OAR 345-021-0010(1)(b)(A)(i): The nominal electric generating capacity and the average electrical generating capacity, as defined in ORS 469.300.

OAR 345-021-0010(1)(b)(A)(i) is not applicable to the Project, because the Project will not generate electricity.

#### 3.2.2 Major Components

OAR 345-021-0010(1)(b)(A)(ii): Major components, structures and systems, including a description of the size, type and configuration of equipment used to generate electricity and useful thermal energy.

The Project does not include equipment used to generate electricity or useful thermal energy. Therefore, OAR 345-021-0010(1)(b)(A)(ii) does not apply to the Project.

##### 3.2.2.1 Transmission Line System

The Project is an approximately 296.6-mile-long, electric transmission line. Approximately 272.8 miles of the transmission line are in Oregon and 23.8 miles are in Idaho. The Project is primarily a single-circuit 500-kV electric transmission line with 270.8 miles of single-circuit 500-kV electric transmission line, removal of 12 miles of existing 69-kV transmission line, rebuilding of 0.9 mile of a 230-kV transmission line, and rebuilding of 1.1 miles of an existing 138-kV transmission line.

The transmission line system is made up of ROW, transmission and foundation structures, conductors, grounding system, communication station sites, and associated hardware. Figure B-14 illustrates the typical transmission line construction activities including foundation and roads.

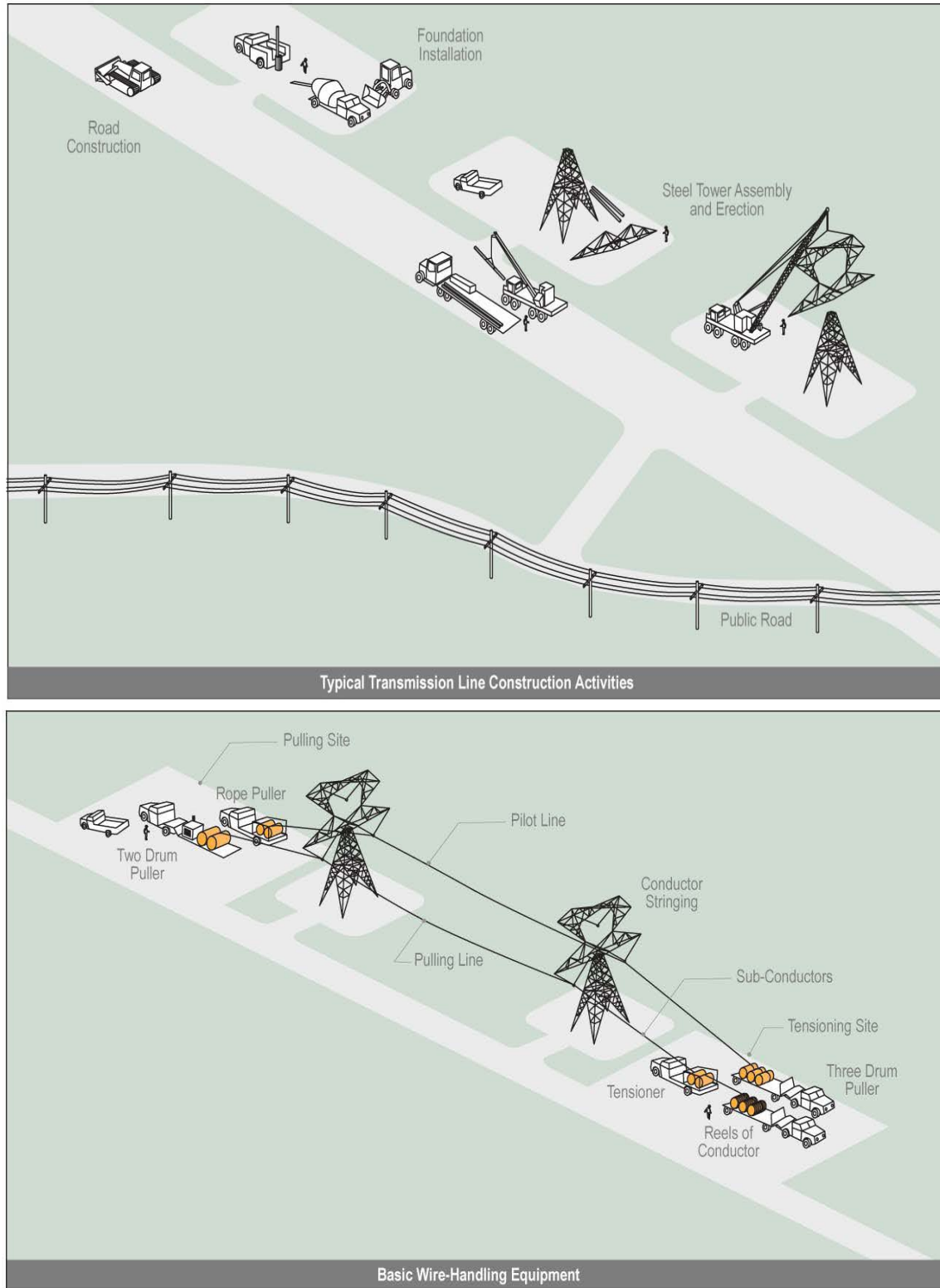

Figure B-14. Illustration of Transmission Line Components

## Transmission Structures

Table B-8 describes structure characteristics for the Proposed Route. Table B-9 describes the structure characteristics for the alternatives. The majority of the proposed transmission line circuits will be supported by 500-kV single-circuit steel lattice towers.

Figure B-15 illustrates the proposed 500-kV single-circuit lattice steel structure configuration. Figure B-16 illustrates the alternative 500-kV single-circuit tubular steel pole Y-frame structure that would be used along the east edge of the NWSTF Boardman for West of Bombing Range Road Alternatives 1 and 2 where shorter structure heights are required. Figure B-17 illustrates the proposed/alternative 500-kV single-circuit tubular steel pole H-frame structure. Figure B-18 illustrates the alternative 500-kV single-circuit H-frame structure that will be used to reduce visual impacts to protected areas. Figure B-19 provides an illustration of a typical 230-kV single-circuit H-frame structure. Figure B-20 illustrates the proposed route rebuild single-circuit 138-kV wooden H-frame structure that would be used for approximately 1.1 miles.

**Table B-8. Proposed Route Structure Characteristics**

Structure Type	Number of Structures	Height (ft)	Distance Between Structures (ft)	Construction Disturbance Area per Structure (ft)	Operational Disturbance Area per Structure (ft)
Proposed 500-kV Single-Circuit Lattice Steel Structure (Figure B-15)	1,076	109-200	1,200-1,800	250 x 250 (1.4 acres)	50 x 50 (0.06 acre)
Proposed/Alternative 500-kV Single-Circuit Tubular Steel Pole H-Frame Structure (NWSTF Boardman area) (Figure B-17)	70	65-105	350-950	90 x 250 (0.5 acre) on NWSTF <u>and</u> 150 x 250 (0.9 acre) off NWSTF	40 x 10 (0.001 acre)
Proposed Route Rebuild Single-Circuit 138-kV Wood H-Frame Structure (Figure B-20)	9	51-61	500-750	250 x 150 (0.9 acre)	16.5 x 5 (0.001 acre)
Proposed/Alternative 500-kV Single-Circuit Tubular Steel Pole H-Frame (Figure B-18)	6	65-105	450-900	250 x 250 (1.4 acre)	40 x 10 (0.001 acre)
Proposed Route Rebuild Single-Circuit 230-kV Steel H-Frame Structure (Figure B-19)	5	57-75	400-1,200	250 x 100 (0.6 acre)	25 x 5 (0.01 acre)
500-kV Single-Circuit H-Frame	5	85-145	950-1650	250 x 250 (1.4 acres)	40 x 10 (0.001 acre)
Proposed 230-kV Single-Circuit Tubular Steel 3-Pole Dead-end	4	61-66	NA	250 x 150 (0.9 acre)	130 x 40 (0.01 acre)
Proposed 500-kV Single-Circuit Tubular Steel 3-Pole Dead-end	4	115	NA	250 x 250 (1.4 acres)	90 x 10 (0.02 acre)
Proposed 500-kV Single Circuit Tubular Steel 3-Pole Dead-end (NWSTF Boardman area)	3	115	NA	90 x 250 (0.5 acre)	90 x 10 (0.02 acre)
Proposed 500-kV Single-Circuit Tubular Steel 3-Pole Dead-end	3	75-90	NA	250 x 250 (1.4 acres)	90 x 10 (0.02 acre)



Structure Type	Number of Structures	Height (ft)	Distance Between Structures (ft)	Construction Disturbance Area per Structure (ft)	Operational Disturbance Area per Structure (ft)
138-kV Single-Circuit 3-Pole Dead-end	3	51.5	NA	250 x 150 (0.9 acre)	130 x 30 (0.09 acre)

ft – feet; NA – Not Applicable; NWSTF – Naval Weapons Systems Training Facility

**Table B-9. Alternative Routes Structure Characteristics**

Structure Type	Number of Structures	Height (ft)	Distance Between Structures (ft)	Construction Disturbance Area per Structure (ft)	Operational Disturbance Area per Structure (ft)
Proposed 500-kV Single-Circuit Lattice Steel Structure (Figure B-15)	114	109-200	1,200-1,800	250 x 250 (1.4 acres)	50 x 50 (0.06 acre)
Alternative 500-kV Single-Circuit Tubular Steel Pole H-Frame (NWSTF Boardman area) (Figure B-18)	33	90-100	550-1100	90 x 250 (0.5 acre) on NWSTF <u>and</u> 150 x 250 (0.9 acre) off NWSTF	40 x 10 (0.001 acre)
Alternative 500-kV Single-Circuit Tubular Steel Pole Y-Frame (NWSTF Boardman area) (Figure B-16)	8	85-95	575-980	Varies (0.4 acre)	8 x 8 (0.001 acre)
500-kV Single-Circuit, H-Frame Dead-end (NWSTF Boardman area)	2	95-100	NA	90 x 250 (0.5 acre)	50 x 10 (0.01 acre)
500-kV Single-Circuit, 3-Pole Dead-end (NWSTF Boardman area)	2	115	NA	90 x 250 (0.5 acre)	90 x 10 (0.02 acre)

ft – feet; NA – Not Applicable; NWSTF – Naval Weapons Systems Training Facility

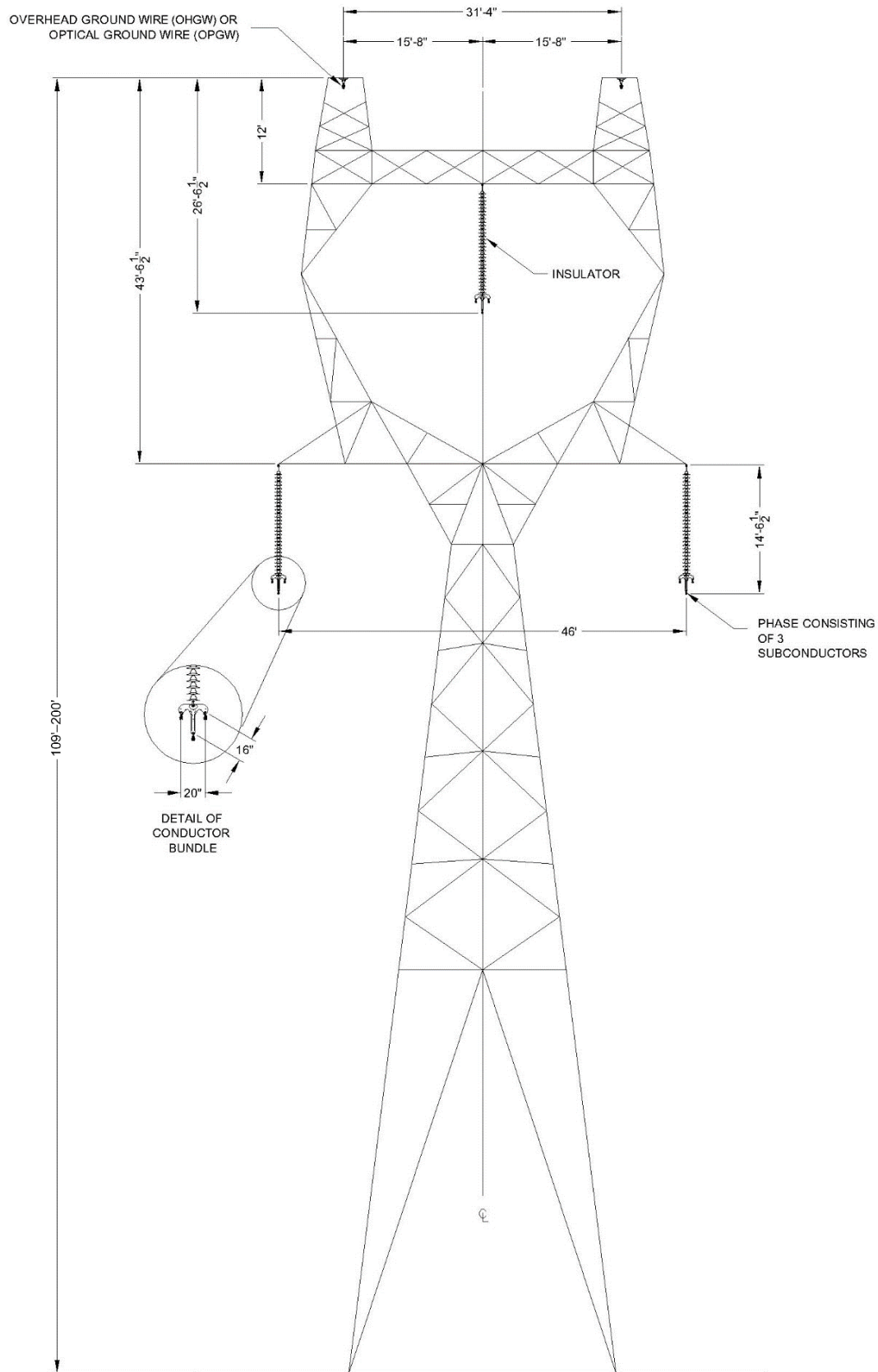
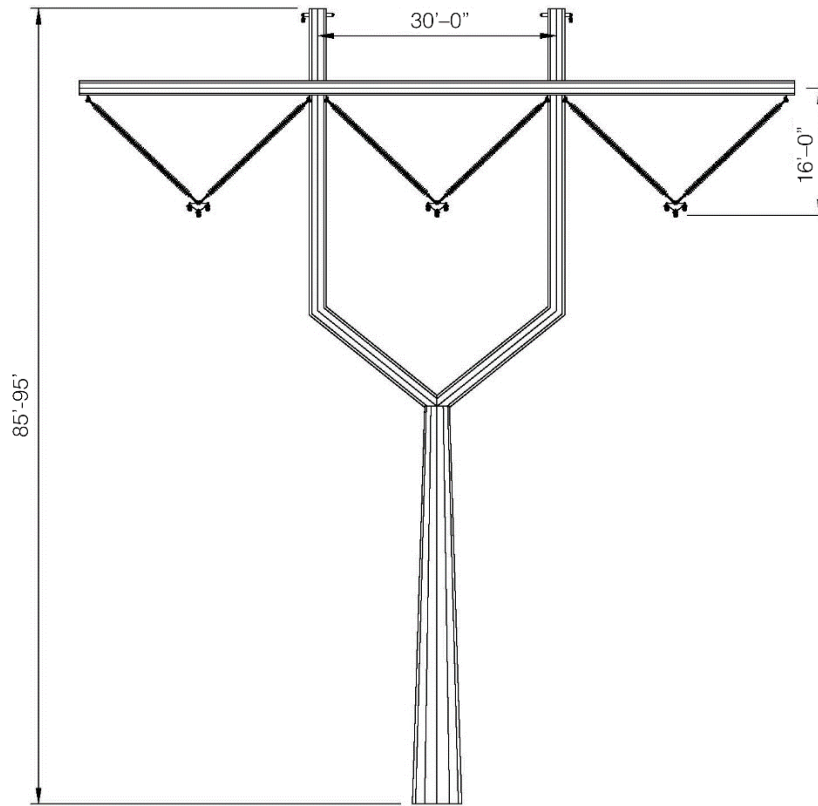
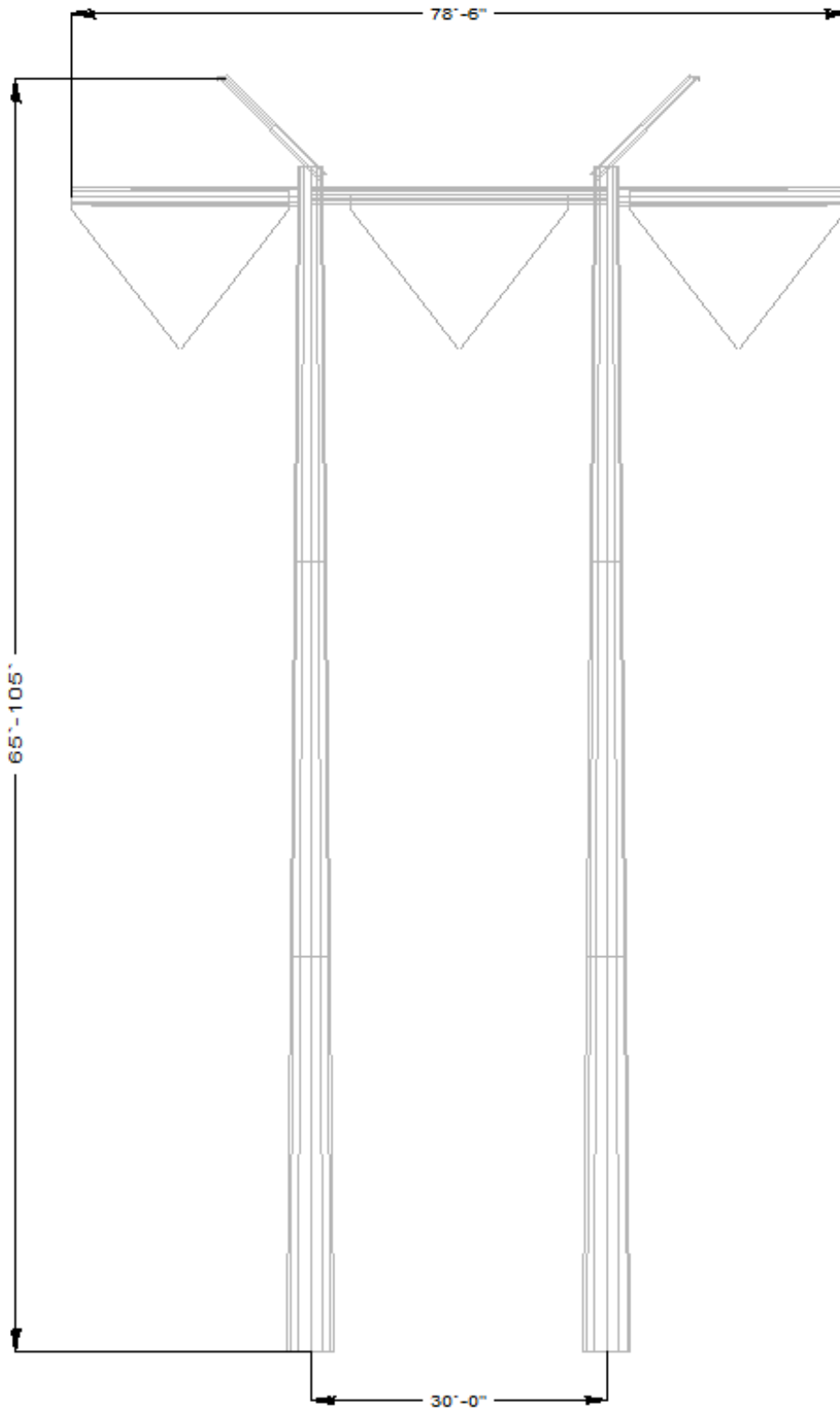

Figure B-15. Proposed 500-kV Single-Circuit Lattice Steel Structure



**Figure B-16. Alternative 500-kV Single-Circuit Tubular Steel Pole Y-Frame Structure**



**Figure B-17. Proposed/Alternative 500-kV Single-Circuit Tubular Steel Pole H-Frame Structure**

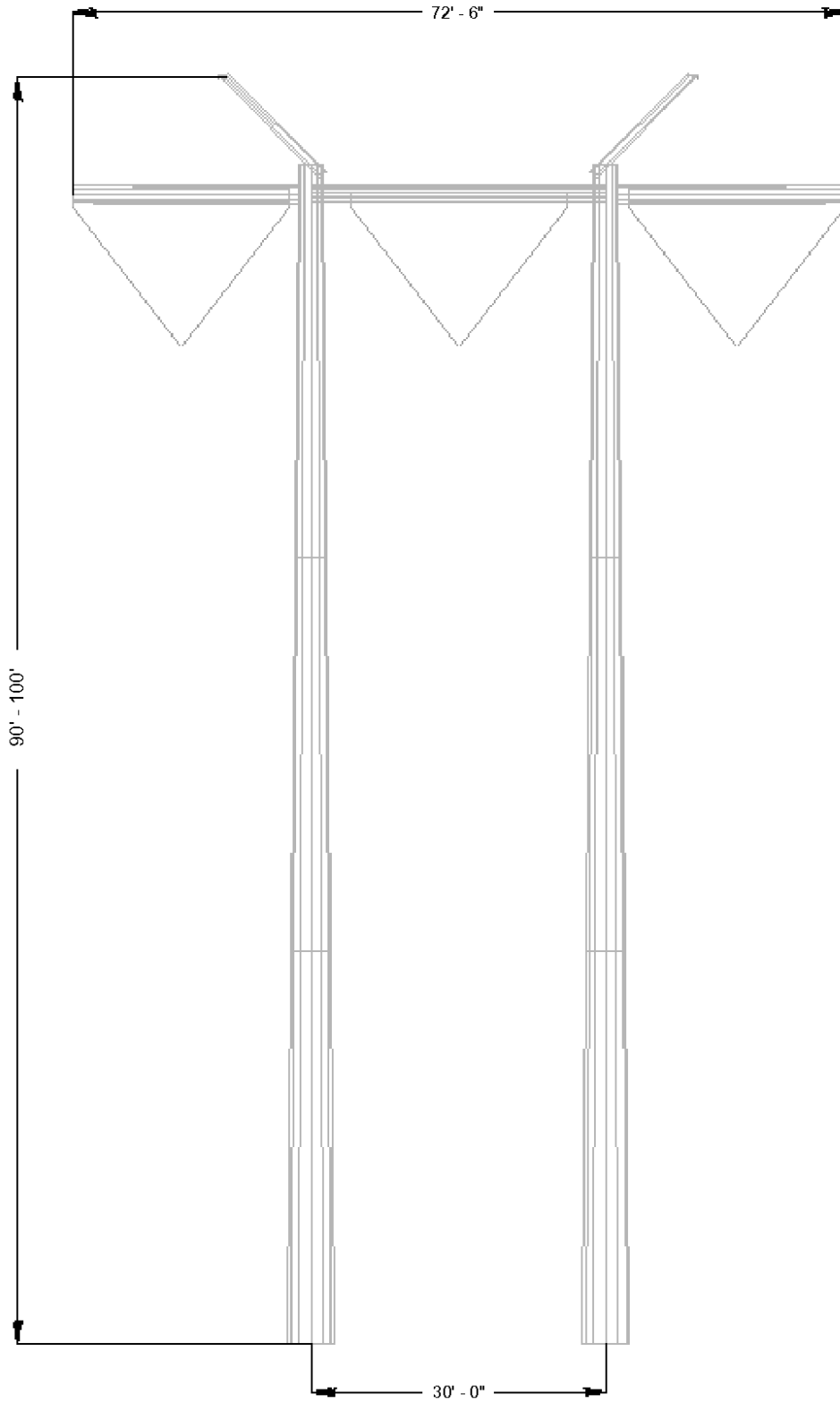

**Figure B-18. Proposed/Alternative 500-kV Single-Circuit Tubular Steel Pole H-Frame Structure**

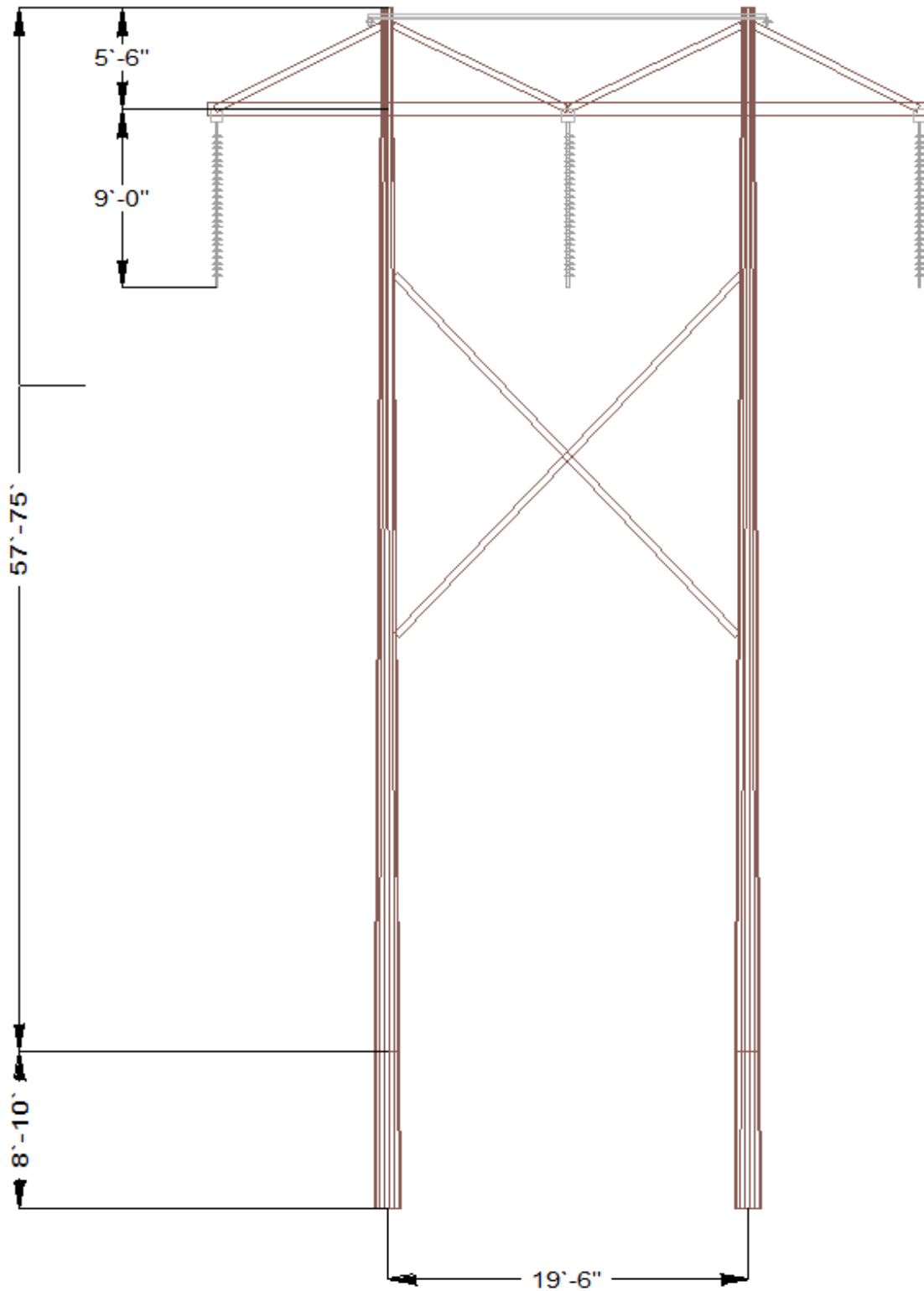
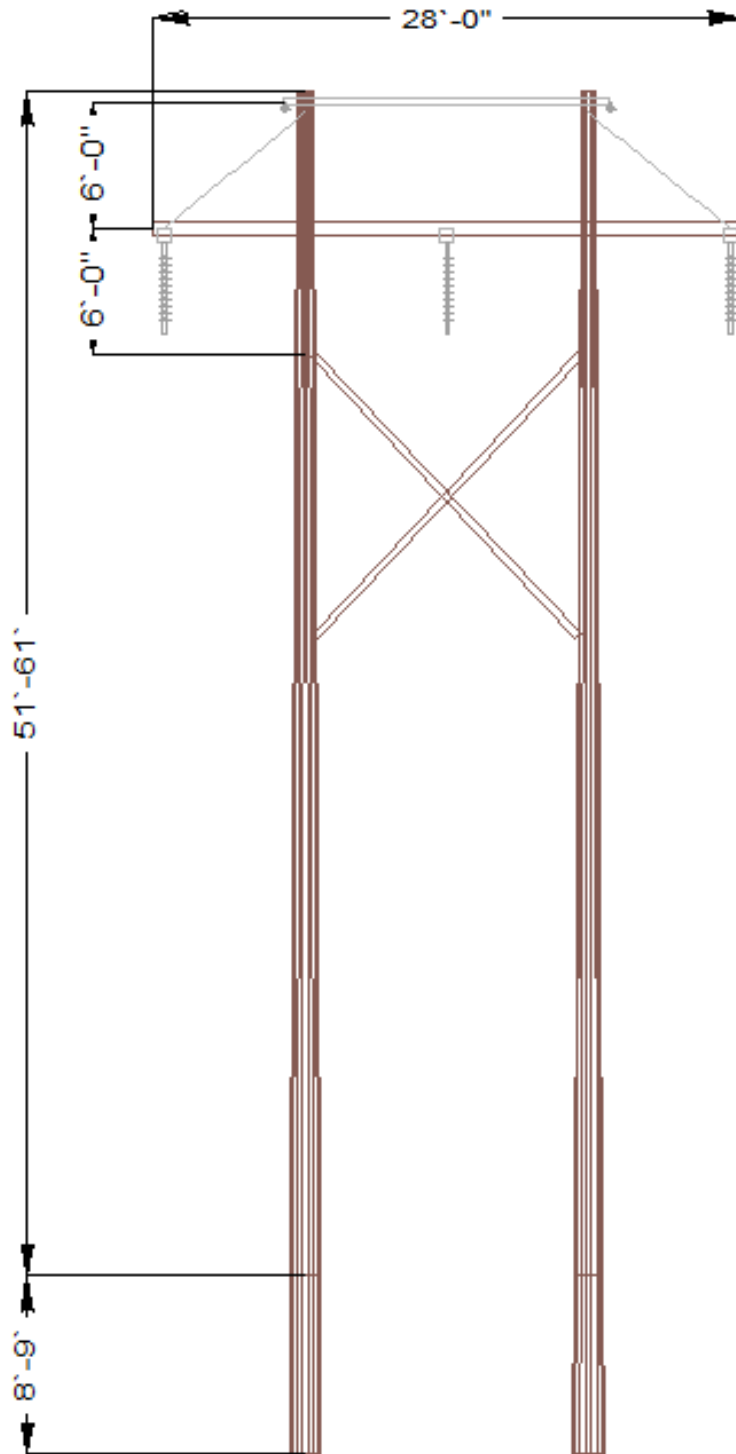

Figure B-19. Proposed Route Rebuild Single-Circuit 230-kV Steel H-Frame Structure



**Figure B-20. Proposed Route Rebuild Single-Circuit 138-kV Wood H-Frame Structure**

IPC will also use several types of support structures for special purposes as described below.

- *Tangent Structures* – Tangent structures are the most common type of structure and will be used along straight sections of the alignment. These structures are designed to support a range of wind and ice loading conditions but will only support loads associated with very slight line angles (0 to 1 degrees).
- *Angle Structures* – Angle structures are used at angle points along the transmission line corridor. Angle structures that are not designed as dead-end or terminal structures are called “running” angle structures. “Running” angle structures are designed to support a range of wind and ice loading conditions and will support loads associated with moderate line angles up to 25 degrees. Angle structures are typically designed for a specific range angles: 3 to 10 degrees, 10 to 25 degrees, etc.
- *Dead-End Structures* – Dead-end structures are generally used at station termination points, line angles greater than 25 degrees, on each end of long spans such as those crossing canyons and wide rivers, and other points along the transmission line where it is appropriate to support the tension in the conductor. Dead-end structures are designed to support the vertical loads, transverse loads, line angle loads (where appropriate), and the longitudinal load of the conductor. Dead-end structures may also be used in situations where maintaining clearance is difficult with tangent structures.
- *Tubular Steel Frames* – Tubular steel structures are fabricated from high strength plate steel formed into tubes. Tubular poles can be fabricated into various structure configurations including the H-frame and Y-frame structures that will be used on this Project. Tubular steel may be painted, galvanized, or made from weathering steel. Tubular H-frame and Y-frame steel structures will be bolted to drilled piers, piles, or a cast-in-place foundation, allowing their use in various soil types.
- *Transmission Line Crossing Structures* – Transmission line crossing structures are fabricated from high strength steel. These structures may be delta configuration lattice steel towers or tubular H-frame structures. Preferably, these structures are located perpendicular to the line being crossed. These structures' arrangements will allow the 500-kV line to cross over the top of lower voltage transmission lines or under other 500-kV lines when necessary. Crossing structures will have the same design properties as other transmission structures.
- *Transposition Structures* – At certain points along the transmission line corridor, it may be necessary to install transposition structures. A transposition structure is a transmission structure used to “transpose” each of the three phases (or conductors) in the transmission circuit so that each phase changes its relative place in the transmission circuit. Transposition structures used on the Project will be modified dead-end structures with added arms and insulator strings that will allow the phases to move to different positions on the structure. The need to install a transposition structure is dependent on the electrical characteristics and length of the line and the need to balance the electrical impedance of the transmission line between stations.

### **Removal of Existing 69-kV Structures**

Removal of the existing 69-kV transmission line structures along the eastern boundary of the NWSTF Boardman would be completed using two specific methods. The majority of the structures would be removed by taking down the overhead conductor and removing each of the wooden poles at 3 inches below ground surface. The poles would be lifted by cranes onto trucks and removed from the site.

Removal of three of the H-frame structures that occur in WAGS habitat would be removed by cutting the poles into sections, transporting the pole sections by foot to the nearest existing



road, and driving the pole sections off-site. The construction contractor will climb the poles and remove the sections starting at the top. The poles will be removed down to slightly above ground level in order to eliminate potential raptor perching structures while avoiding ground disturbance. The below grade portions of the poles will be left in place. Alternatively, the wooden pole structures could be removed by using a helicopter in conjunction with hand crews working on the ground.

### **Right-of-Way Width**

The ROW width for the majority of the single-circuit 500-kV line will be up to 250 feet. The ROW width requested along the east edge of NWSTF Boardman will be up to 90 feet. The ROW width for the 1.1-mile rebuilding of existing 138-kV transmission line will be up to 100 feet. The existing 138-kV ROW will be widened to 250 feet to facilitate placement of the 500-kV line within it. The ROW width for the 0.9-mile single-circuit 230-kV rebuilding portion will be up to 125 feet. The existing 230-kV ROW will be widened to 250 feet to facilitate placement of the 500-kV line within it.

Figures B-21 through B-24 illustrate the ROW width requirements for the proposed and alternative tangent structures. The determination of these widths is based on three criteria:

1. Sufficient National Electrical Safety Code (NESC) clearance must be maintained to the edge of the ROW during a wind event when the conductors are blown towards the ROW edge.
2. Sufficient room must be provided within the ROW to perform transmission line maintenance.
3. Sufficient clearances must be maintained from the transmission line to the edge of the ROW where structures or trees may be located and deemed a hazard or danger to the transmission line. A narrower ROW could be accommodated in some areas, but in others the full 250 feet (125 feet on each side of the centerline) would be required. A narrower ROW in forested areas can result in reliability problems. Falling trees are a major cause of outages and damage to transmission lines. In addition, many forest managers are resistant to allowing utilities to remove hazardous trees, which makes reducing the ROW in forested areas not feasible.

Specific localized conditions may result in slightly different ROW widths. These will be finalized during the detailed design.

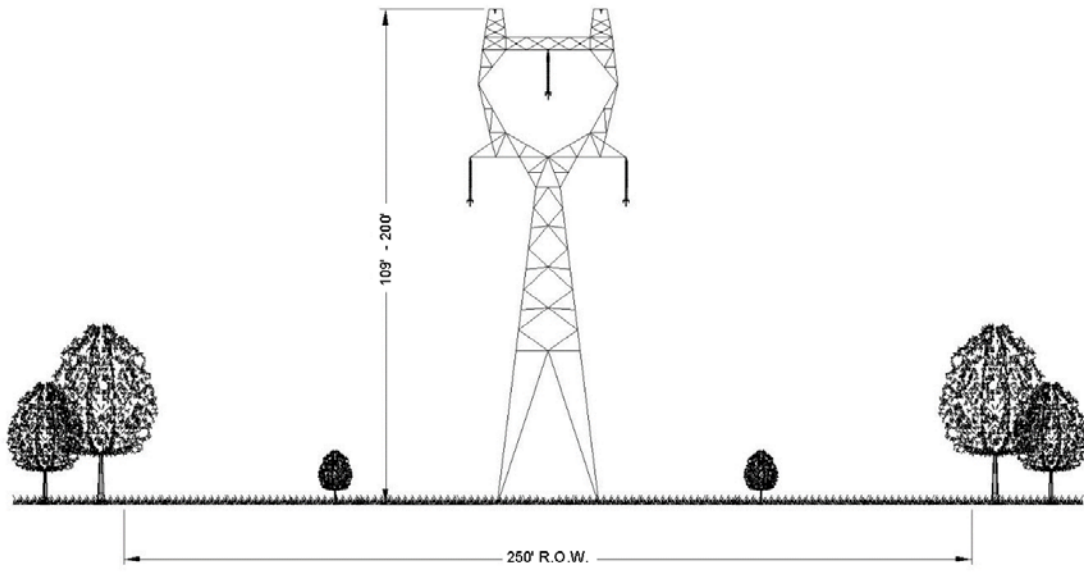

PROPOSED 500-KV LATTICE STEEL ROW DESIGN.

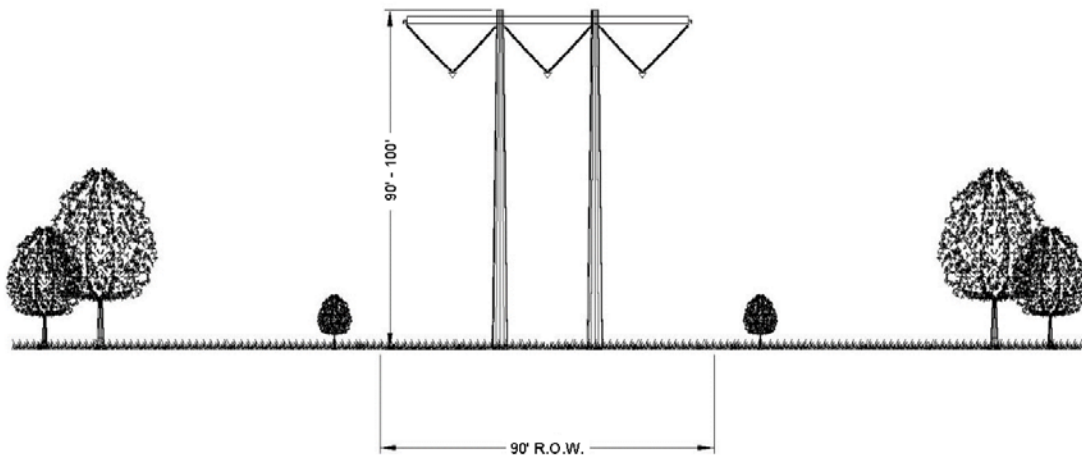

PROPOSED 500-KV STEEL POLE H-FRAME

Figure B-21. 500-kV ROW Designs

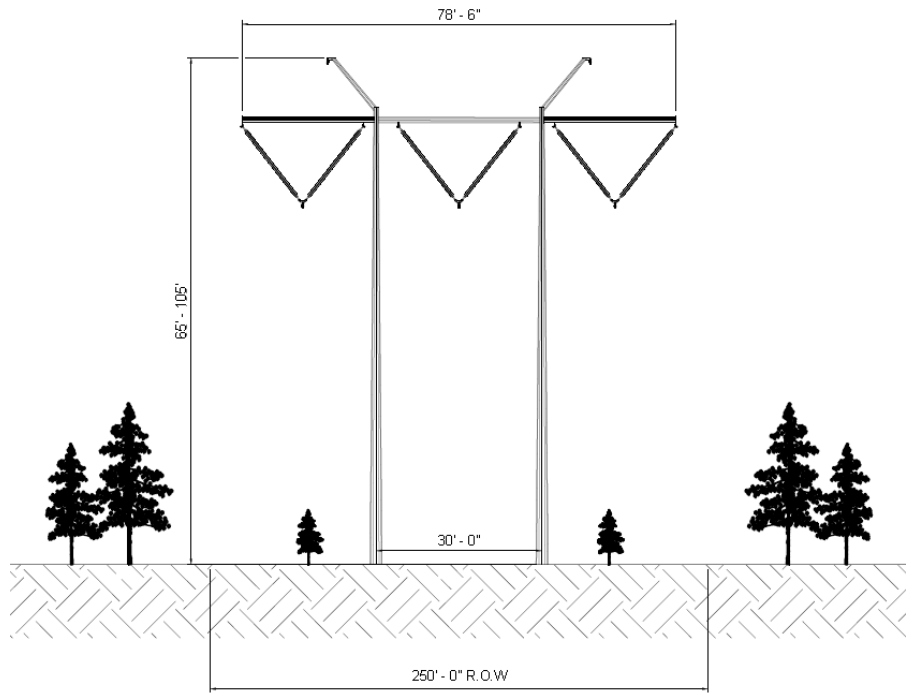

PROPOSED/ALTERNATIVE 500-KV H-FRAME STEEL ROW DESIGN

Figure B-22. Proposed/Alternative 500-kV ROW Designs

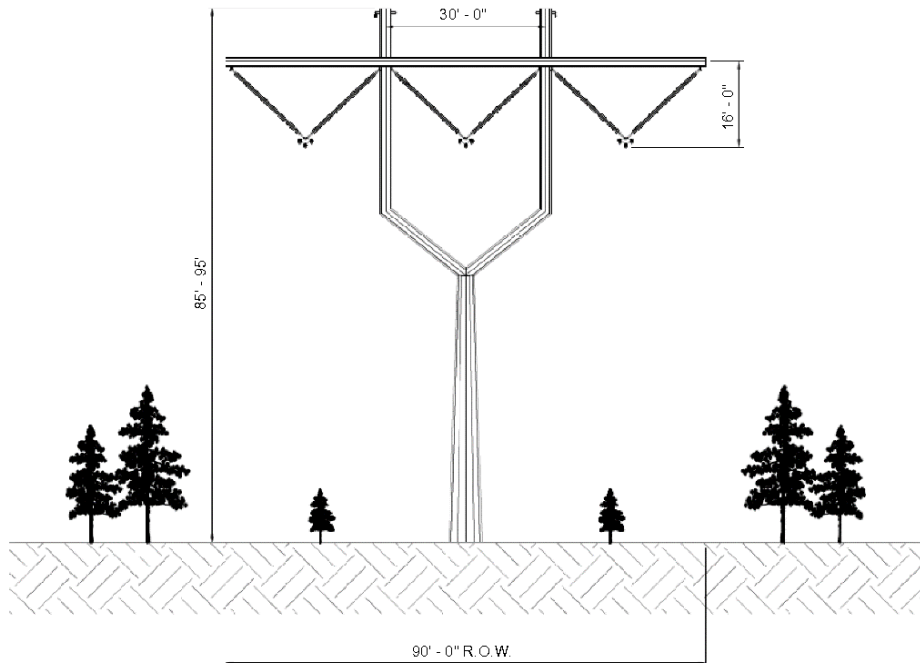

ALTERNATIVE 500-KV Y-FRAME STEEL ROW DESIGN

Figure B-23. Alternative 500-kV ROW Designs

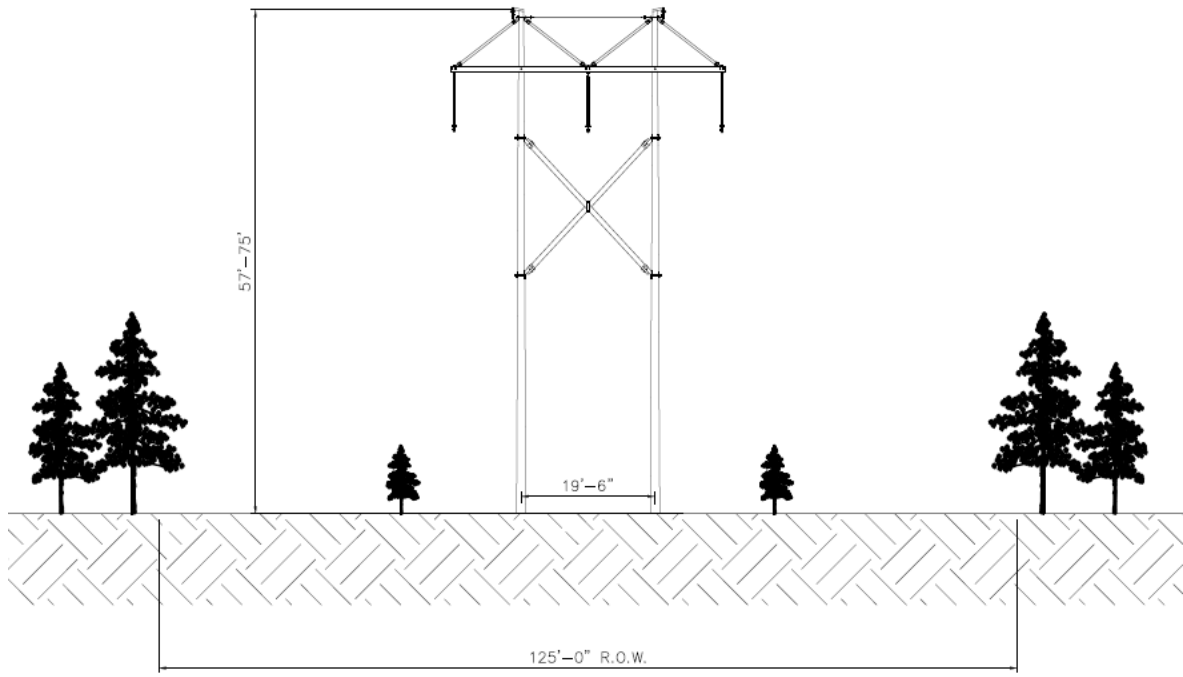

PROPOSED REBUILD 230-KV H-FRAME STEEL ROW DESIGN

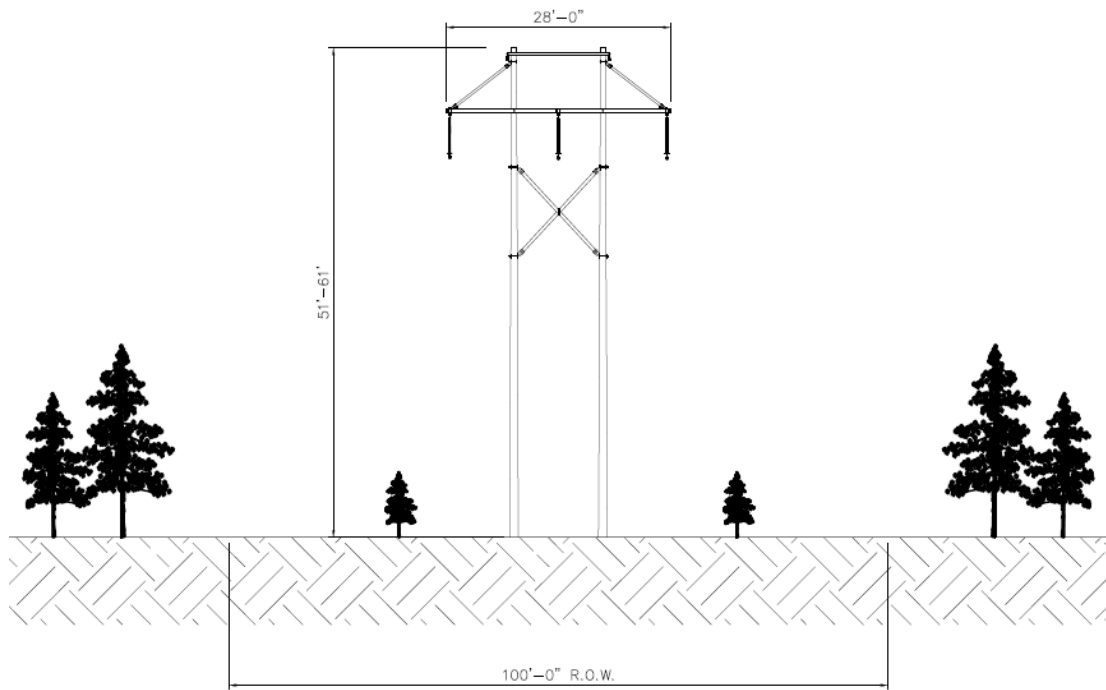

PROPOSED REBUILD 138-KV H-FRAME WOOD ROW DESIGN

Figure B-24. 230-kV and 138-kV ROW Designs

## Structure and Conductor Clearances

Conductor phase-to-phase and phase-to-ground clearance parameters are determined in accordance with IPC company standards and the NESC, ANSI C2, produced by the American National Standards Institute (ANSI). These documents provide minimum distances between the conductors and ground, crossing points of other lines and the transmission support structure, and other conductors, and minimum working clearances for personnel during energized operation and maintenance activities (IEEE 2011). At normal operating conditions, the minimum clearance of conductors above ground is 34.5 feet for 500-kV lines, 27 feet for 230-kV lines, and 30 feet for 138-kV lines.

## Structure Foundations

The 500-kV single-circuit lattice steel structures each require four foundations, one on each of the four corners of the lattice towers. The foundation style, diameter, and depth will be determined during final design and are dependent on structure loading conditions and the type of soil or rock present at each specific site. The preliminary design indicates the foundations for the single-circuit tangent lattice towers will be composed of steel-reinforced concrete drilled piers with a typical diameter of 4 feet and a depth of approximately 15 feet. For the 500-kV H-frame structures, each tangent structure will require two foundations, one for each pole that comprises the H-frame structure. Angle and dead-end structures will use a three-pole structure, each with its own foundation. They will be steel-reinforced drilled piers with a typical diameter of 6 to 8 feet and a depth of approximately 25 to 40 feet. The 138-kV H-frame structures will be direct-embedded wood poles. Tangent structures will be direct-embedded in a single drilled boring, typically 5 feet in diameter and 15 feet deep. Angle and dead-end structures will be on steel-reinforced drilled pier foundations with a typical diameter of 5 to 6 feet and a depth of approximately 20 to 25 feet. For the 230-kV H-frame structures, each of the two poles for tangent structures will be direct-embedded. Each of the three poles that make up the angle and dead-end structures will be direct-embedded and guyed. Typical direct-embedded foundations sizes will be 5 feet in diameter and 12 feet deep.

Typical foundation diameters and depths for the proposed structure families are shown in Table B-10.

**Table B-10. Foundation Excavation Dimensions**

Structure Type	Number of Holes per Structure	Depth (feet)	Diameter (feet)	Concrete (cubic yards)
500-kV Single-Circuit 3-Pole Dead-end	3	30	9	212
500-kV Single-Circuit H-Frame	2	25	8	93
500-kV Single-Circuit Lattice, Heavy Dead-end	4	30	6	126
500-kV Single-Circuit Lattice, Heavy Tangent	4	16	4	30
500-kV Single-Circuit Lattice, Light Tangent	4	16	4	30
500-kV Single-Circuit Lattice, Medium Dead-end	4	22	6	93
500-kV Single-Circuit Lattice, Small Angle	4	16	6	68

Structure Type	Number of Holes per Structure	Depth (feet)	Diameter (feet)	Concrete (cubic yards)
500-kV Single-Circuit Y-Frame, Tangent	1	43	8	80
500-kV Single-Circuit H-Frame, Tangent	2	25	8	93
230-kV Single-Circuit 3-Pole Dead-end, Guyed	3	12	4	NA
230-kV Single-Circuit H-Frame, Tangent	2	12	4	NA
138-kV Single-Circuit 3-Pole Dead-end	3	9	4	NA
138-kV Single-Circuit H-Frame, Tangent	2	9	4	NA

NA – not applicable

### Conductors

The proposed conductor for the 500-kV lattice structure lines is aluminum conductor steel reinforced with trapezoidal aluminum wires. Each phase of a 500-kV three-phase circuit will be composed of three subconductors in a triple bundle configuration. The individual conductors will be bundled in a triangular configuration with spacing of 20 inches between horizontal subconductors and 16 inches of diagonal separation between the top two conductors and the lower conductor (see Figure B-15). The triple-bundled configuration is proposed to provide adequate current carrying capacity and to provide for a reduction in audible noise and radio interference as compared to a single large-diameter conductor. Each 500-kV subconductor will have a 36/7 aluminum/steel stranding, with an overall conductor diameter of 1.300 inches and a weight of 1.616 pounds per foot and a non-specular finish.<sup>12</sup>

Where multiple conductors are utilized in a bundle for each phase, the bundle spacing will be maintained through the use of conductor spacers at intermediate points along the conductor bundle between each structure. The spacers serve a dual purpose: in addition to maintaining the correct bundle configuration and spacing, the spacers are also designed to damp out wind-induced vibration in the conductors. The number of spacers required in each span between towers will be determined during the final design of the transmission line.

The proposed rebuilt 230-kV line will be a three-phase circuit composed of one conductor. Each conductor will have an overall diameter of 1.107 inches and a weight of 1.093 pounds per foot and a non-specular finish.

The proposed 138-kV rebuilt line will have one conductor per phase.

### Other Hardware

#### Insulators

As shown in Figure B-15, the typical insulator assemblies for 500-kV steel lattice tangent structures will consist of an insulator string hung in the form of an "I." As shown in Figures B-16 and B-17, insulator assemblies for 500-kV H-frame structures will consist of two insulator strings

<sup>12</sup> Non-specular finish refers to a "dull" finish rather than a "shiny" finish.

hung in the form of a V. As shown in Figure B-18, insulator assemblies for the alternative 500-kV H-frame will consist of one insulator string hung in the form of an “I” on the outside and two insulator strings hung in the form of “V” on the inside. As shown in Figure B-18, insulator assemblies for 230-kV H-frame structures will consist of a single insulator suspended from the structure cross arm in the form of an “I.” As shown in Figure B-20, insulator assemblies for 138-kV tangent structures will consist of one insulator string hung in the form of an “I” that extend vertically down from the crossbar. Insulators are used to suspend each conductor bundle (phase) from the structure, maintaining the appropriate electrical clearance between the conductors, the ground, and the structure. Dead-end insulator assemblies for the transmission lines will use an I-shaped configuration, which consists of insulators hung from either a tower dead-end arm or a dead-end pole in the form of an “I.” Insulators will be composed of green-tinted toughened glass.

### **Grounding Systems**

Alternating current (AC) transmission lines such as the Project transmission lines have the potential to induce currents on adjacent metallic structures such as transmission lines, railroads, pipelines, fences, or structures that are parallel to, cross, or are adjacent to the transmission line. Induced currents on these facilities will occur to some degree during steady-state operating conditions and during a fault condition on the transmission line. For example, during a lightning strike on the line, the insulators may flash over, causing a fault condition on the line and current will flow down the structure through the grounding system (i.e., ground rod or counterpoise) and into the ground. The magnitude of the effects of the AC induced currents on adjacent facilities is highly dependent on the magnitude of the current flows in the transmission line, the proximity of the adjacent facility to the line, and the distance (length) for which the two facilities parallel one another in proximity.

The methods and equipment needed to mitigate these conditions will be determined through electrical studies of the specific situation. As standard practice and as part of the design of the Project, electrical equipment and fencing at the station will be grounded. All fences, metal gates, pipelines, metal buildings, and other metal structures adjacent to the ROW that cross or are within the transmission line ROW will be grounded as determined necessary. If applicable, grounding of metallic objects outside of the ROW may also occur, depending on the distance from the transmission line as determined through the electrical studies. These actions address the majority of induced current effects on metallic facilities adjacent to the line by shunting the induced currents to ground through ground rods, ground mats, and other grounding systems, thus reducing the effect that a person may experience when touching a metallic object near the line (i.e., reduce electric shock potential). Transmission line public health effects are discussed in Exhibit AA, Section 3.10.

During final design of the transmission line, appropriate electrical studies will be conducted to identify the issues associated with paralleling other facilities and the types of equipment that will need to be installed (if any) to mitigate the effects of the induced currents.

### **Minor Additional Hardware**

In addition to the conductors, insulators, and overhead shield wires, other associated hardware will be installed on the tower as part of the insulator assembly to support the conductors and shield wires. This hardware will include clamps, shackles, links, plates, and various other pieces composed of galvanized steel and aluminum.

A grounding system will be installed at the base of each transmission structure that will consist of copper or copper-clad ground rods embedded into the ground in immediate proximity to the structure foundation and connected to the structure by a buried copper lead. When the resistance to ground for a grounded transmission structure is greater than a specified

impedance value with the use of ground rods, counterpoise will be installed to lower the resistance to below a specified impedance value. Counterpoise consists of a bare copper-clad or galvanized-steel cable buried a minimum of 12 inches deep, extending from structures (from one or more legs of structure) for approximately 200 feet within the ROW.

Other hardware that is not associated with the transmission of electricity may be installed as part of the Project. This hardware may include aerial marker spheres or aircraft warning lighting as required for the conductors or structures per Federal Aviation Administration regulations.<sup>13</sup> Structure proximity to airports and structure height are the determinants of whether Federal Aviation Administration regulations will apply based on an assessment of wire/tower strike risk. IPC does not anticipate that structure lighting will be required because proposed structures will be less than 200 feet tall and will not be near airports that require structure lighting.

### 3.2.2.2 Stations

As explained above in Section 1.2, IPC identified the need for a Project endpoint in the Boardman, Oregon, area because it is the easternmost point at which IPC can feasibly interconnect to the Pacific Northwest market.

#### **Proposed Longhorn Station**

The terminus for the Proposed Route is the proposed Longhorn Station. BPA has planned the Longhorn Station on land it purchased from the Port of Morrow. In this application, IPC is requesting authorization to develop (construct and operate) the Longhorn Station if the BPA does not develop the Longhorn Station on a timely basis.

The Longhorn Station location is described in more detail in Exhibit C, Section 3.2 and in Attachment C-1. For termination of the Project 500-kV line at the Longhorn Station, IPC would install 500-kV circuit breakers, high-voltage switches, bus supports, and transmission line termination structures, a 500-kV series capacitor bank, and 500-kV shunt reactor banks. The 500-kV transmission line termination structures are approximately 125 to 135 feet tall. A control house to accommodate the necessary system communications, control equipment, and a restroom facility will be constructed. A new all-weather access road will be used to reach the site, and the site would be supplied by distribution power brought in from the nearby existing system as necessary. Fiber optic signal communication equipment and a backup propane-powered generator will be installed. Figure B-25 is a photograph of a typical 500-kV station with multiple line connections.

---

<sup>13</sup> U.S. Department of Transportation, Federal Aviation Administration, Advisory Circular AC 70/7460-1K Obstruction Marking and Lighting, August 1, 2000; and Advisory Circular AC 70/7460-2K Proposed Construction or Alteration of Objects that May Affect the Navigable Airspace, March 1, 2000.





**Figure B-25. Typical 500-kV Station**

### 3.2.2.3 *Communication System*

#### ***Optical Ground Wire***

Reliable and secure communications for system control and monitoring is very important to maintain the operational integrity of the Project and of the overall interconnected system. Primary communications for relaying and control will be provided via the optical ground wire (OPGW) that will be installed on the transmission lines; this path is intended for IPC use.<sup>14</sup> No new microwave sites are planned for the Project. Each 500-kV structure will have two lightning protection shield wires installed on the structure peaks (see Figures B-15 and B-16). One of the shield wires will be composed of extra high strength steel wire with a diameter of 0.495 inch and a weight of 0.517 pound per foot. The second shield wire will be an OPGW constructed of aluminum and steel, and will carry 48 glass fibers within its core. The OPGW will have a diameter of 0.646 inch and a weight of 0.407 pound per foot. The glass fibers inside the OPGW shield wire will provide optical data transfer capability among IPC's facilities along the fiber path. The data transferred are required for system control and monitoring.

#### ***Communication Station Sites***

As the data signal is passed through the optical fiber cable, the signal degrades with distance. Consequently, signal communication station sites are required to amplify the signals if the distance between communication station sites exceeds approximately 40 miles. The locations of communication station sites are listed in Exhibit C, Table C-11 and shown on the maps in Attachment C-2. A total of 10 proposed and 2 alternative communication station sites have been identified. Communication station sites will be located on private lands; IPC has located the communication station sites within the ROW for the transmission line.

Facility service power will be required at each of the ten communication station sites ultimately selected for development. Typically, facility service power is provided from a local electric distribution line located in proximity to the station communication station site. The voltage of the

<sup>14</sup> A secondary communication path will be used made up of the existing trunk communications systems currently in use by the BPA and IPC.

distribution supply line is typically 34.5-kV or lower and carried on wood poles. Distribution lines will be developed by local electric service providers; the local electric service providers will be responsible for any additional permitting required to develop distribution lines.

The typical communication station site will be 100 feet by 100 feet, with a fenced area of 75 feet by 75 feet. A prefabricated concrete communications structure with dimensions of approximately 11.5 feet by 32 feet by 12 feet tall will be placed on the site and access roads to the site and power from the local electric distribution circuits will be required. A standby generator with a liquefied propane gas tank will be installed at the site inside the fenced area. Two separate conduit (underground) or aerial cable routes will be used for each fiber optic cable bundle between the transmission line and communication station. Conduit will be 2-inch-diameter polyvinyl chloride and will be buried 3 feet below the surface extending from the communication shelter to two different legs of the transmission structure maintaining a 10-foot separation between the cables. All work will occur within the disturbance footprint for either the communication station or the structure to which the cables will attach. Figure B-26 illustrates the plan arrangement of a typical communications station site layout.

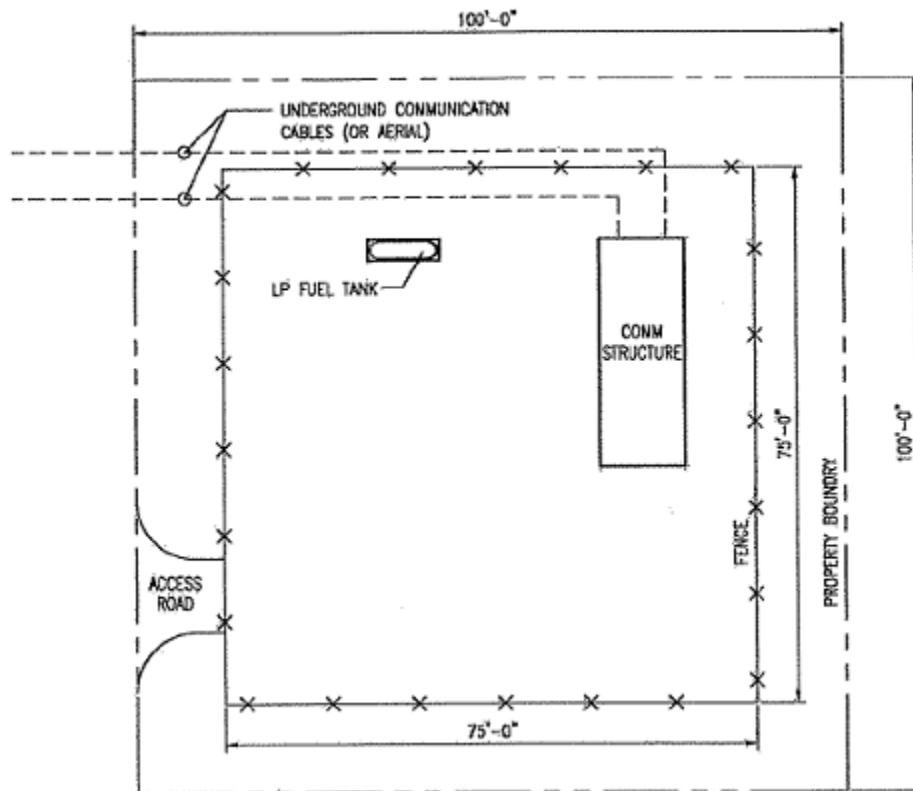

**Figure B-26. Typical Communication Station Site Layout**

### 3.2.3 Site Plan and General Arrangement

OAR 345-021-0010(1)(b)(A)(iii): A site plan and general arrangement of buildings, equipment and structures.

The general arrangement of a station and a communication station are shown in Figures B-25 and B-26. The general arrangement of multi-use areas and pulling and tensioning sites are shown in Figures B-27 and B-28 (see Sections 3.3.2 and 3.3.3 below).

### 3.2.4 Fuel and Chemical Storage Facilities

OAR 345-021-0010(1)(b)(A)(iv): Fuel and chemical storage facilities, including structures and systems for spill containment.

During construction, gasoline, diesel fuel, crankcase oil, lubricants, and cleaning solvents will be present along the transmission line corridor, typically at multi-use areas, and at the Longhorn Station construction site. These products will be used to fuel, lubricate, and clean vehicles and equipment and will be transported in containerized trucks or in other federal and state approved containers. Enclosed containment will be provided for petroleum products and wastes and petroleum-related construction waste will be removed to a disposal facility authorized to accept such materials. Fuel and chemicals will be properly stored to prevent drainage or accidents. A typical example drawing of a spill containment area used during construction, including dimensions of spill containment area, is included in Exhibit G. Where required, preventive measures such as the use of vehicle drip pans for overnight parking areas may be implemented. Routine visual inspection for presence of petroleum leaks will be required for vehicles. Diesel fuel tanks will be located at the multi-use areas for vehicle and equipment fueling. Each fuel tank will be located within secondary containment and each station will be equipped with a spill kit. When on-ROW refueling is necessary, it will be done away from waterways. Accidental releases of hazardous materials will be prevented or minimized through proper containment of these substances during use and transportation to the site. A Spill Prevention, Containment, and Countermeasures Plan has been prepared for this Project (see Exhibit G, Attachment G-4). All hazardous and dangerous materials will be stored and secured in accordance with the appropriate regulations as discussed in Exhibit G.

During operations, no fuels or potentially hazardous materials such as general lubricants, general cleaners, ethylene glycol (antifreeze), vehicle fuel, or herbicides for weed control will be stored on the ROW. When used, they will be stored and disposed of in accordance with applicable local, state, federal environmental laws and regulations, and product labels where applicable. At the communication stations, liquid propane will be stored in approved tanks. Reactors at the termination station will be filled with an insulating mineral oil. Secondary containment structures will be installed to prevent oil from this equipment from reaching ground or water bodies in the event of a rupture or leak. IPC will use a standard type of oil containment consisting of a pit of a calculated capacity under the oil-filled equipment that has an oil-impervious liner. The pit is filled with rock to grade level. In case of an oil leak or rupture, the oil captured in the containment pit is removed and transported to a disposal facility.

Exhibit G, Section 3.3 describes quantities and handling procedures for fuel, lubricating oils, transformer oils, and other petroleum products and chemicals in greater detail.

### 3.2.5 Equipment and Systems for Fire

OAR 345-021-0010(1)(b)(A)(v): Equipment and systems for fire prevention and control.

During construction, the risk of fire danger is related to smoking, refueling activities, operating vehicles and other equipment off improved roadways, welding activities, and the use of explosive materials and flammable liquids. During operation, the risk of fire is primarily from vehicles and maintenance activities that require welding.

All federal, state, and county laws, ordinances, rules, and regulations pertaining to fire prevention and suppression will be strictly adhered to. All personnel will be advised of their responsibilities under the applicable fire laws and regulations.

The prevention and suppression of wildfires in eastern Oregon is carried out by BLM, USFS, and local fire districts and agencies (Table B-11). The agencies' activities are closely coordinated, primarily through the Pacific Northwest Wildfire Coordinating Group. Coordination of firefighting resources also occurs under Oregon's *Emergency Conflagration Act* that allows the state fire marshal to mobilize and dispatch structural firefighting personnel and equipment when a significant number of structures are threatened by fire and local structural fire-suppression capability is exhausted (OSFM 2007).

**Table B-11. Fire Suppression Responsibilities in Oregon**

Who	Where	Miles of Proposed Route
City fire departments and rural fire protection districts in mutual aid with Oregon Department of Forestry	Structures in Oregon's wildland interface areas covered by mutual-aid agreements. Rangeland fire protection associations on rangeland areas of eastern Oregon outside of both a forest protection district and a rural fire district.	193.8
BLM and BOR	National System of Public Lands and BOR-managed lands	69.9
USFS	National Forest and National Grasslands	7.1

BLM – Bureau of Land Management; BOR – Bureau of Reclamation; USFS – United States Department of Agriculture Forest Service

Source: ODEQ 2003

If IPC becomes aware of an emergency situation that is caused by a fire on or threatening BLM-managed or National Forest lands they will notify the appropriate agency contact. Specific construction-related activities and safety measures will be implemented during construction of the transmission line to prevent fires and to ensure quick response and suppression if a fire occurs. Typical practices to prevent fires during construction and maintenance/repair activities include brush clearing prior to work, posting a fire watch, and stationing a water truck at the job site to keep the ground and vegetation moist in extreme fire conditions, enforcing red flag warnings, providing “fire behavior” training to all construction personnel, keeping vehicles on or within designated roads or work areas, and providing fire suppression equipment and emergency notification numbers at each construction site.

IPC will require its contractor to maintain a list, to be provided to local fire-protection agencies, of all equipment that is either specifically designed for, or capable of, being adapted to fighting fires. IPC will require its contractor to provide basic fire-fighting equipment on-site during construction, including fire extinguishers, shovels, axes, and other tools in sufficient numbers so each employee on-site can assist in the event of a fire-fighting operation.

During transmission line operation, the risk of fire danger is minimal. The primary causes of fire on the ROW result from unauthorized entry by individuals for recreational purposes and from fires started outside the ROW. In the latter case, authorities can use the ROW as a potential point of attack for fighting a fire. During transmission line operation, access to the ROW will be restricted in accordance with jurisdictional agency or landowner requirements to minimize recreational use of the ROW.

During maintenance operations, IPC or its contractor will equip personnel with basic fire-fighting equipment, including fire extinguishers, shovels, and polaskis as described above. Maintenance crews will also carry emergency response/fire control phone numbers.

At the Longhorn Station, fire protection systems will be installed. Typical fire protection systems that could be used include:

- Automatic suppression systems such as fire sprinklers, foam, gaseous, explosion suppression, or other specialized extinguishing systems plus appropriate alarms.
- Adequate water supply, storage, and distribution systems are essential elements of water-based extinguishing systems.
- Automatic fire detection, occupant warning, manual fire alarm, and fire alarm reporting systems combined with properly equipped and adequately trained fire departments.
- Fire barrier systems or combinations of physical separation and barriers for outdoor locations.

At communication stations, smoke detectors will be installed that will alarm through the Supervisory Control and Data Acquisition system, which communicates to IPC's System Dispatch Center along the fiber optic lines.

Specific fire protection systems will be determined during final design of these Project facilities.

Exhibit U, Section 3.5.6 provides specific information on the effect of the Project on public and private fire protection providers. Exhibit U, Attachment U-3 contains a project-specific Fire Prevention and Suppression Plan that outlines responsibilities, notification procedures, fire prevention measures and precautions, fire suppression equipment, and initial response procedures.

### 3.3 Related and Supporting Facilities

OAR 345-021-0010(1)(b)(B): A description of major components, structures and systems of each related or supporting facility.

Permanent and temporary related and supporting facilities include access roads, multi-use areas, pulling and tensioning sites, light-duty fly yards within some pulling and tensioning sites, and communication station distribution lines.

#### 3.3.1 Access Roads

The Project will require vehicular access during construction of the station, each communication station site, and each transmission structure, as well as temporary facilities including multi-use areas and pulling and tensioning sites. As described in Attachment B-5, Road Classification Guide and Access Control Plan, access roads included in the Site Boundary include:

- New roads; and
- Existing roads requiring substantial modification.

Existing roads that will be used for construction and operation of the Project but will not require substantial modification are not "related and supporting facilities"<sup>15</sup> and, therefore, are not included in the Site Boundary. Table B-12 provides a summary of the access road classifications.

<sup>15</sup> ORS 469.300(24) and OAR 345-001-0010(51).

**Table B-12. Summary of Access Road Classifications**

Access Road Classification		Site Boundary	Construction Disturbance	Operations Disturbance	Road Prism or Profile Changes	Extent of Work
New Roads	Primitive	200 feet	16 feet	10 feet	Yes	Clearing of vegetation or obstructions. Create roads by direct vehicle travel.
	Bladed	200 feet	16–35 feet	14 feet	Yes	Clearing of vegetation or obstructions. Create roads by cutting/filling existing terrain.
Existing Roads - Substantial Modification	Substantial Modification, 21-70% Improved	100 feet	16 feet	14 feet	Yes	Reconstruct portions of existing road to improve road function. Possible road prism widening, profile adjustments, horizontal curve adjustments, or material placement.
	Substantial Modification, 71-100% Improved	100 feet	16–30 feet	14 feet	Yes	Reconstruct portions of existing road to improve road function. Possible road prism widening, profile adjustments, horizontal curve adjustments, or material placement.
Existing Roads – No Substantial Modification	No Substantial Modification, 0-20% Improved	NA <sup>1</sup>	NA <sup>1</sup>	NA <sup>1</sup>	No	Repair of existing road to maintain original road function. No betterment of existing road function or design.

<sup>1</sup> Existing roads with no substantial modifications are not included in the Site Boundary and do not have an operation or construction disturbance width assigned to them.

IPC applied the following definitions to roads.

**Access Road:** A linear travel route designated to support construction, operation and maintenance of the transmission line.

**Road Surface:** The surface of the road on which vehicles would travel.

**Bladed Road:** Roads constructed using heavy equipment and designed to support vehicular traffic. Bladed road features typically include cuts and/or fills to construct a smooth travel surface and manage surface water drainage and include the manipulation or creation of a road prism and profile.

**Road Alignment:** The series of horizontal curves and tangents that define the travel path.

**Road Prism:** The area consisting of the road surface and any cut slope, fill slope and contiguous drainage features. For primitive roads, the road prism is defined as the travel surface and extent of clearing necessary for horizontal clearance or the extent of modification from the natural condition, whichever is greater.

**Road Profile:** The trace of a vertical plane intersecting the surface along the longitudinal centerline of the roadbed.

**Road Segment:** The length of road between intersecting nodes of a branching road network, between substantially different road surface materials (native and non-native material), or between different road classifications.

### 3.3.1.1 *New Roads*

**New Primitive Roads.** New primitive roads are characterized as follows:

- Created by direct vehicle travel over native material and existing vegetation.
- Disturbance may include clearing of large woody vegetation and other obstructions to ensure safe vehicle operation.
- Will generally be present on the landscape as two-track roads leaving no disturbance beyond the edge of the travel surface.
- May require intermittent maintenance work to support continued safe vehicle passage during construction.
- Typical construction disturbance is 16 feet wide. The operational width is 10 feet. The Site Boundary for a new primitive road will be 200 feet wide (100 feet each side of centerline).

**New Bladed Roads.** New bladed roads are characterized as follows:

- Construction of new road prism across side slope over 8 percent or over rough and uneven terrain.
- Typical construction disturbance is 16 feet wide, but can be up to 35 feet wide as dictated by terrain and soil conditions. The operational width is 14 feet. The Site Boundary for a new bladed road will be 200 feet wide (100 feet each side of centerline).

New roads are identified as being primitive or bladed for purposes of describing the disturbance width. The disturbance width may affect the Project's impact analysis elsewhere in the application, but it does not affect the classification of the roads for purposes of determining whether they are included in the Site Boundary. All new roads—primitive or bladed—are considered related or supporting facilities and are included in the Site Boundary.

### 3.3.1.2 Existing Roads – Substantial Modification

To determine whether existing roads will require improvements, IPC conducted field reconnaissance and surveyed aerial photos of existing road segments. If IPC determined improvements to an existing road will involve one or more of the following activities, the road segment was classified as requiring substantial improvements: (1) increasing the width of the existing road prism, (2) changing the existing road alignment, (3) using materials inconsistent with the existing road surface, (4) changing the existing road profile, or (5) involving repairs to more than 20 percent of the road surface area defined by road prism width and longitudinal distance over a defined road segment.

Existing roads that will require substantial modification are characterized as follows:

- Typical construction disturbance is 16 feet wide, but can be up to 30 feet wide when road modification exceeds 70 percent. The operational width is 14 feet. The Site Boundary for a substantial modification existing road will be 100 feet wide (50 feet each side of centerline).

Existing roads requiring substantial modification are identified as requiring 21–70 percent improvements or 71–100 percent improvements. The distinction between the two improvement categories may affect the Project's impact analysis in other sections of the application, but it does not affect the classification of the roads for purposes of determining whether they are included in the Site Boundary. Each existing road requiring improvements to more than 20 percent of the road is considered a related or supporting facility and is included in the Site Boundary.

### 3.3.1.3 Existing Roads – No Substantial Modification.

IPC classified existing road segments as requiring no substantial improvements if the road segments will meet each of the following criteria:

1. road maintenance activities will be limited to repair of the road prism to (i) produce a stable operating surface, (ii) ensure proper drainage and erosion control, and (iii) establish horizontal clearance;
2. proposed repair and/or construction activities will not (i) increase the width of the existing road prism, (ii) change the existing road alignment, (iii) use materials inconsistent with the existing road surface, and/or (iv) change the existing road profile; and
3. repairs will be limited to 20 percent or less of the road surface area defined by the road prism width and longitudinal distance over a defined road segment.

**Note:** Notwithstanding the above criteria, IPC may request that ODOE consider alternative road classifications and determinations of substantial modification for individual road segments.

After construction is completed, any new roads developed for the Project connecting to multi-use areas will be removed and restored to preconstruction conditions, unless the landowner requests otherwise. Roads developed for pulling and tensioning sites will be permanent because they will also provide access to structures for operations and maintenance. Both categories of access roads are shown on maps in Exhibit C, Attachment C-2.

### 3.3.2 Multi-use Areas

Construction of the Project will begin with the establishment of multi-use areas. The multi-use areas will serve as field offices; reporting locations for workers; parking space for vehicles and equipment; and sites for material delivery and storage, fabrication assembly of towers, cross arms and other hardware, concrete batch plants, and stations for equipment maintenance (see Figure B-27 for complete list of potential activities). Multi-use areas, each of which is about 30



acres in size, will be located approximately every 15 miles along the corridor. Multi-use area locations are listed in Exhibit C, Table C-14 and shown on maps in Exhibit C, Attachments C-2 and C-3 and are subject to change with a final design.

Helicopter operations may be staged out of multi-use areas. Project construction activities facilitated by helicopters may include delivery of construction laborers, equipment, and materials to structure sites; structure placement; hardware installation; and wire stringing operations. Helicopters may also be used to support the administration and management of the Project by IPC, the Construction Contractor, or both. Where construction access by truck is not practical due to steep terrain, all-terrain vehicle trails may be utilized to support maintenance activities. The use of helicopter construction methods for this Project will not change the length of the access road system required for operating the Project because vehicle access is required to each tower site regardless of the construction method employed.

During construction, gasoline, diesel fuel, crankcase oil, lubricants, and cleaning solvents will be stored at multi-use areas. These products will be used to fuel, lubricate, and clean vehicles and equipment and will be transported to the multi-use sites in containerized trucks or in other federal and state approved containers. Enclosed containment will be provided for petroleum products and wastes and petroleum-related construction waste will be removed to a disposal facility authorized to accept such materials. Fuel and chemicals will be properly stored to prevent drainage or accidents. Where required, preventive measures such as the use of vehicle drip pans for overnight parking areas may be implemented. Routine visual inspection for presence of petroleum leaks will be required for vehicles. Diesel fuel tanks will be located at the multi-use areas for vehicle and equipment fueling. Each fuel tank will be located within secondary containment and each station will be equipped with a spill kit. When on-ROW refueling is necessary, it will be done away from waterways. Accidental releases of hazardous materials will be prevented or minimized through proper containment of these substances during use and transportation to the site. A Spill Prevention, Containment, and Countermeasures Plan will be prepared for all hazardous materials. All hazardous and dangerous materials will be stored and secured in accordance with the appropriate regulations.

During operations, no fuels or potentially hazardous materials such as general lubricants, general cleaners, ethylene glycol (antifreeze), vehicle fuel, and herbicides for weed control will be stored on the ROW. When used, they will be transported and disposed of in accordance with applicable local, state, federal environmental laws and regulations, and product labels as appropriate. At the communication stations, liquid propane will be stored in approved tanks.

Multi-use areas will be fenced and their gates locked. Security guards will be stationed where needed. In some cases, the multi-use area may need to be scraped by a bulldozer and a temporary layer of rock laid to provide an all-weather surface. Unless otherwise directed by the landowner, the rock will be removed from the multi-use area upon completion and the area will be restored.

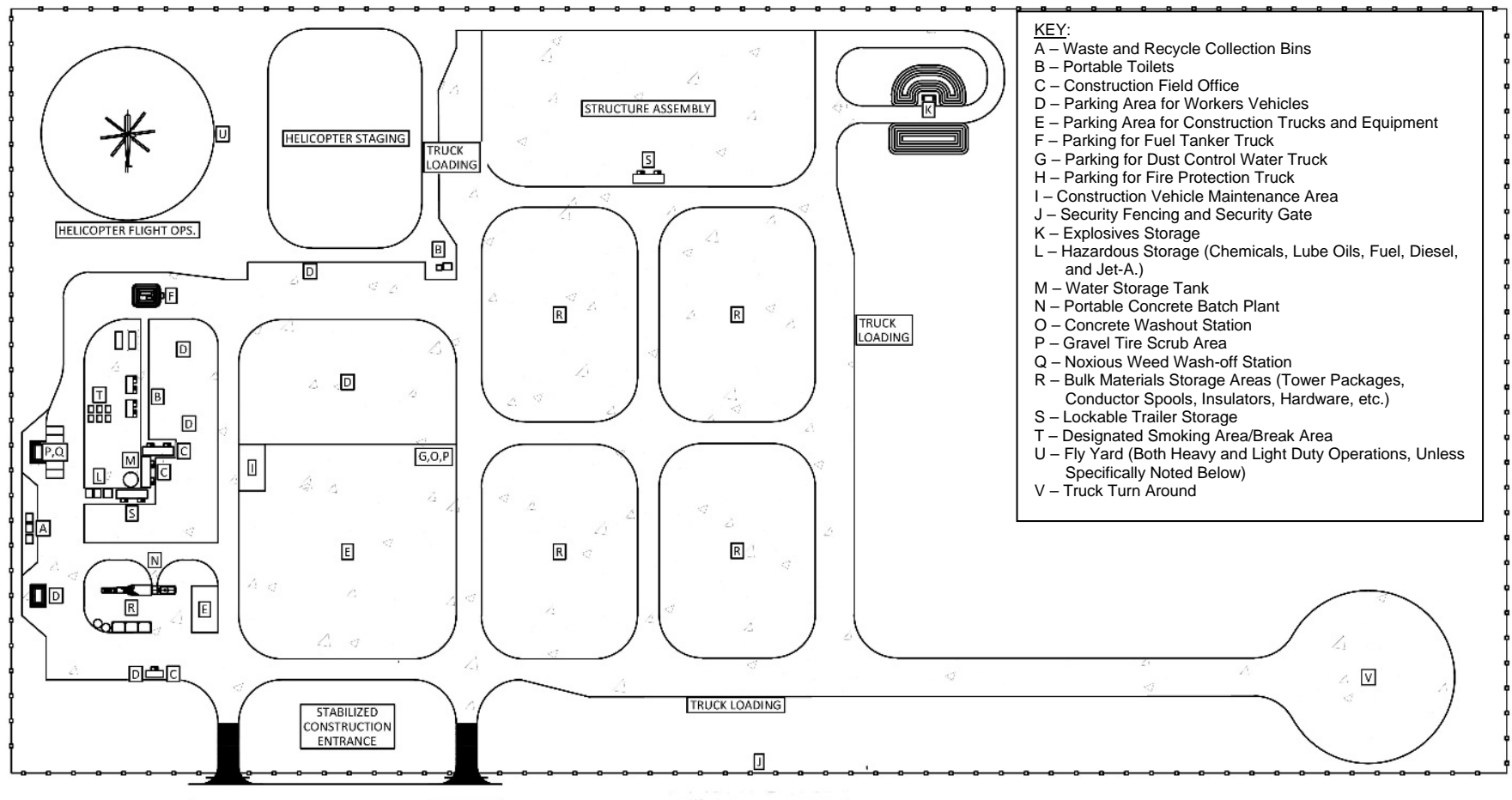

Figure B-27. Multi-use Area Layout

### 3.3.3 Pulling and Tensioning Sites

There will be 299 pulling and tensioning sites required for the Project. Pulling and tensioning sites will be required approximately every 1.5 to 2 miles along the ROW and at angle points greater than 30 degrees and will require approximately 5 acres at each end of the wire section to accommodate required equipment. Equipment at sites required for pulling and tensioning activities will include tractors and trailers with spooled reels that hold the conductors and trucks with the tensioning equipment.

Four pulling and tensioning sites are designated as light-duty fly yards. Light-duty fly yards are similar to the fly yards located in the multi-use areas but are smaller in size (Figure B-28). All of the equipment and activities that occur at a multi-use area may also occur at a light-duty fly yard. The exception would be that no oil and gas or explosive storage will occur and no batch plants will be located at the light-duty fly yards within the pulling and tensioning sites.

Preliminary locations are shown in Exhibit C, Attachment C-2. The light-duty fly yards are located within four specific pulling and tensioning sites along the Project where the spacing between multi-use areas is too great. The light-duty fly yards will be approximately 5-acre sites spaced about 15 miles apart.

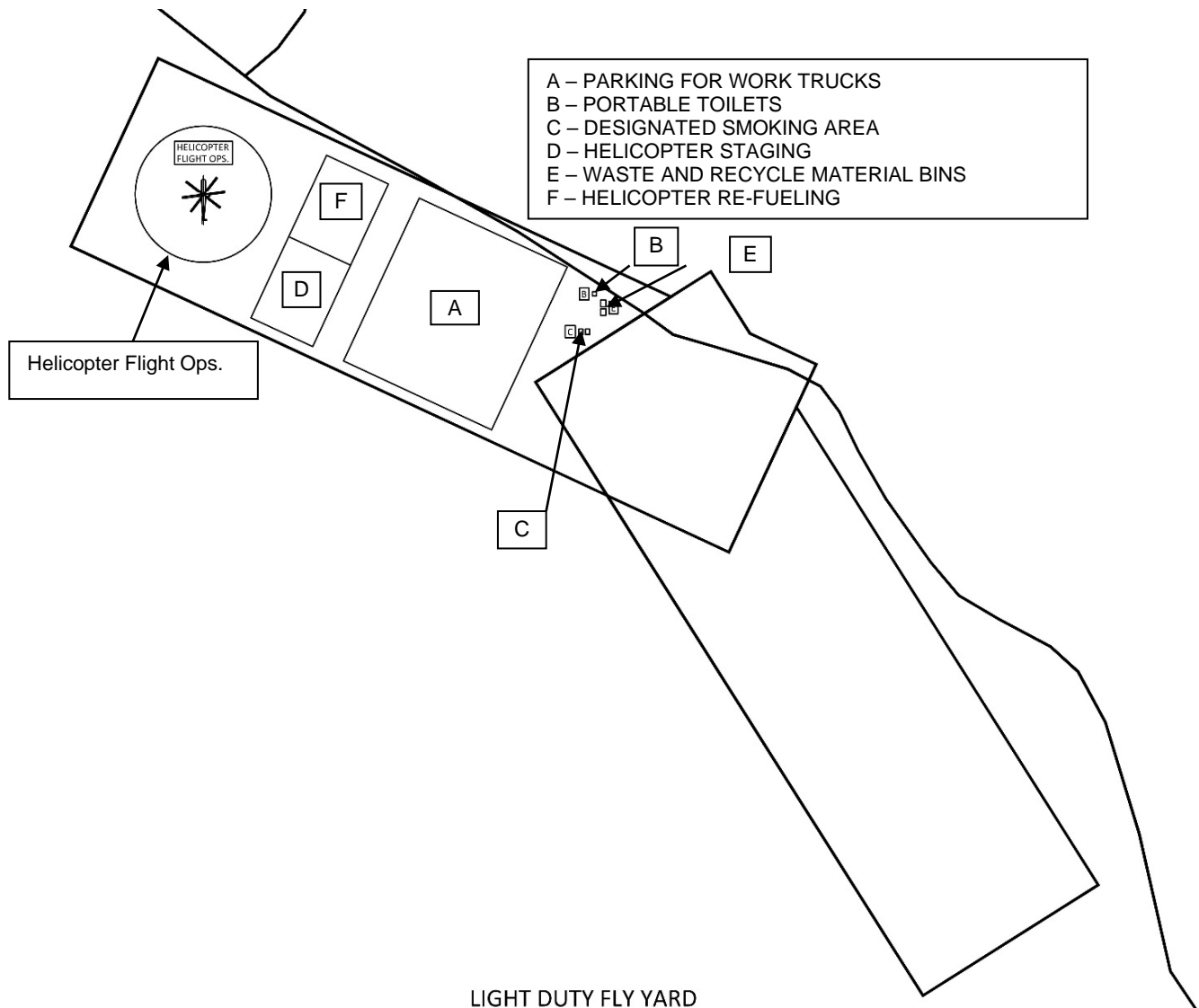

**Figure B-28. Light-Duty Fly Yard on Pulling and Tensioning Site Layout**

### 3.3.4 Communication Station Distribution Lines

As discussed in Section 3.2.2.3, local electric distribution service providers will install distribution lines to serve the Project's communication stations. Where the local service provider is a third party and not IPC, the distribution lines would not be considered related or supporting facilities pursuant to ORS § 469.300(24). However, IPC is the local service provider in Malheur and parts of Baker counties that will be serving communication stations BA-02, and MA-01, MA-02, MA-03, as well as alternative a communication station in Malheur County. Therefore, those distribution lines are considered related or supporting facilities and are included within the Site Boundary.

### 3.4 Approximate Dimensions

OAR 345-021-0010(1)(b)(C): The approximate dimensions of major facility structures and visible features.

Table B-13 describes the dimensions of facility structures and visible features. The final quantity, heights, span lengths, and clearances provided by the structures and ROW widths will depend on the final detailed design of the transmission line.<sup>16</sup>

**Table B-13. Project Structures and Visible Feature Dimensions**

Facility	Description
Longhorn Station Expansion or Construction	<ul style="list-style-type: none"> <li>• Existing access road.</li> <li>• The Bonneville Power Administration Longhorn Station will be built to terminate the Boardman to Hemingway Transmission Line Project line. The fenced area will be approximately 20 acres.</li> <li>• Tie to existing McNary to Coyote Springs high voltage transmission line.</li> <li>• 500-kV circuit breakers and related switching equipment.</li> <li>• Bus and support structures.</li> <li>• 500-kV line termination structures approximately 135 feet in height.</li> <li>• Control, protection, and communications equipment added inside the control building.</li> <li>• 500-kV series capacitor bank.</li> <li>• 500-kV shunt reactor bank.</li> <li>• Existing electric distribution line.</li> </ul>

<sup>16</sup> Note that diagrams of structures in this exhibit are not drawn to scale relative to each other.

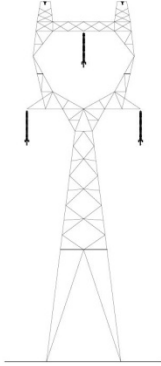
Facility	Description
<p data-bbox="203 235 472 296">Proposed 500-kV Single-Circuit Lattice</p> 	<ul style="list-style-type: none"> <li>• Proposed 500-kV structure type: Self-supporting steel lattice towers having a dulled galvanized steel finish.</li> <li>• Structure heights: lattice tower varies between 109 to 200 feet.</li> <li>• Approximate span distance between structures: lattice: 1,200 to 1,800 feet.</li> <li>• Right-of-way (ROW) width: lattice: nominal 250 feet.</li> <li>• Three-phase 500-kV construction for all tower designs, conductor spacing, and clearances.</li> <li>• Conductors: Non-specular finish.</li> <li>• Subconductor diameter is 1.300 inches.</li> <li>• Bundle spacing: Subconductor bundle has a spacing of 20 inches between horizontal sub-conductors and 16 inches of diagonal spacing between the top two sub-conductors and the lower sub-conductor.</li> <li>• Two Shield Wires: One optical ground wire (OPGW) containing 48 fibers and having a diameter of 0.646 inch. One overhead ground wire (OHGW) made of extra high strength (EHS) steel and having a diameter of 0.5 inch.</li> <li>• Minimum ground clearance: 34.5 feet.</li> <li>• Line length: Approximately 270.8 miles (Oregon only).</li> <li>• The final quantity, heights, span lengths, and clearances provided by the structures and ROW widths will depend on the final detailed design of the transmission line.</li> </ul>

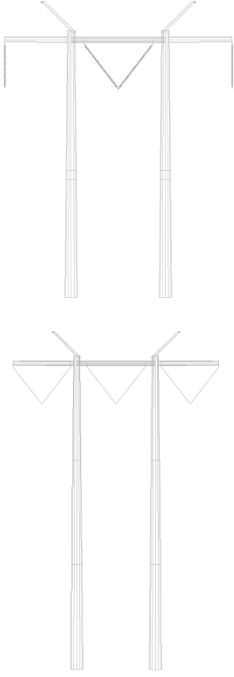
Facility	Description
<p data-bbox="203 235 505 296">Proposed 500-kV Single-Circuit H-Frame</p> 	<ul style="list-style-type: none"> <li>• Proposed 500-kV structure type: Self-supporting tubular steel H-frame structures, having a weathering steel (Corten) finish.</li> <li>• Number of poles per H-frame: 2.</li> <li>• Approximate pole diameters: 48 to 72 inches (at base), 16 to 24 inches (at tip).</li> <li>• Structure heights: 65-105 feet and 90-100 feet.</li> <li>• Approximate span distance between structures: 350 to 1,650 feet.</li> <li>• ROW width: 90-250 feet.</li> <li>• Three-phase 500-kV construction for all tower designs, conductor spacing, and clearances.</li> <li>• Conductors: Non-specular finish.</li> <li>• Subconductor diameter is 1.300 inches.</li> <li>• Bundle spacing: Subconductor bundle has a spacing of 20 inches between horizontal sub-conductors and 16 inches of diagonal spacing between the top two sub-conductors and the lower sub-conductor.</li> <li>• Two Shield Wires: One OPGW containing 48 fibers and having a diameter of 0.646 inch. One OHGW made of EHS steel and having a diameter of 0.5 inch.</li> <li>• Minimum ground clearance: 34.5 feet.</li> <li>• Line length: approximately 13 miles. The final quantity, heights, span lengths, and clearances provided by the structures and ROW widths will depend on the final detailed design of the transmission line.</li> </ul>

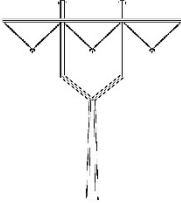
Facility	Description
<p data-bbox="203 233 516 432">Alternative 500-kV Single-Circuit Y-Frame (Applicable to West of Bombing Range Road Alternative 2 in portions of NWSTF Boardman)</p> 	<ul data-bbox="573 233 1425 1123" style="list-style-type: none"> <li>• Proposed 500-kV structure type: Self-supporting tubular steel Y-frame structures, having a weathering steel (Corten) finish.</li> <li>• Number of poles per Y-frame: 1.</li> <li>• Approximate tubular steel pole diameters: 60 to 84 inches at the base.</li> <li>• Structure heights: variable between 85 to 95' feet.</li> <li>• Approximate span distance between structures: 575-980 feet.</li> <li>• ROW width: varies, up to 90 feet.</li> <li>• Three-phase 500-kV construction for all tower designs, conductor spacing, and clearances.</li> <li>• Conductors: Non-specular finish.</li> <li>• Subconductor diameter is 1.300 inches.</li> <li>• Bundle spacing: Subconductor bundle has a spacing of 20 inches between horizontal sub-conductors and 16 inches of diagonal spacing between the top two sub-conductors and the lower sub-conductor.</li> <li>• Two Shield Wires: One OPGW containing 48 fibers and having a diameter of 0.646 inch. One OHGW made of EHS steel and having a diameter of 0.5 inch.</li> <li>• Minimum ground clearance: 34.5 feet.</li> <li>• Line length: Approximately 1.3 miles.</li> <li>• The final quantity, heights, span lengths, and clearances provided by the structures and ROW widths will depend on the final detailed design of the transmission line.</li> </ul>

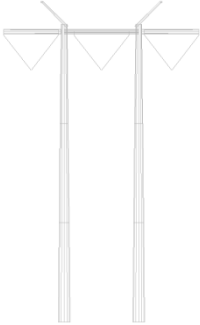
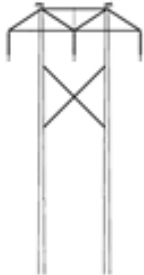
Facility	Description
<p>Alternative 500-kV Single-Circuit Steel Pole H-Frame <i>(Used only if required to address specific land manager requirements or constraints)</i></p> 	<ul style="list-style-type: none"> <li>• Alternative 500-kV structure types: Self-supporting tubular steel H-frame structures, having a weathering steel (Corten) finish.</li> <li>• Approximate tubular steel pole diameters: H-frame structures = 48 to 72 inches (at base), 16 to 24 inches (at tip).</li> <li>• Structure heights: variable between 85 to 165 feet.</li> <li>• Approximate span distance between structures: 600-1,300 feet.</li> <li>• ROW width: nominal 250 feet.</li> <li>• Three-phase 500-kV construction for all tower designs, conductor spacing, and clearances.</li> <li>• Conductors: Non-specular finish.</li> <li>• Subconductor diameter is 1.300 inches.</li> <li>• Bundle spacing: Subconductor bundle has a spacing of 20 inches between horizontal sub-conductors and 16 inches of diagonal spacing between the top two sub-conductors and the lower sub-conductor.</li> <li>• Two Shield Wires: One OPGW containing 48 fibers and having a diameter of 0.646 inch. One OHGW made of EHS steel and having a diameter of 0.5 inch.</li> <li>• Minimum ground clearance : 34.5 feet.</li> <li>• Line length: Undetermined.</li> <li>• The final quantity, heights, span lengths, and clearances provided by the structures and ROW widths will depend on the final detailed design of the transmission line.</li> </ul>
<p>Single-Circuit 230-kV Transmission Line <i>(Applicable to 230-kV rebuild portion of Proposed Route)</i></p> 	<ul style="list-style-type: none"> <li>• Proposed structure type: Steel pole H-frame structures. Tangent H-frame structures are self-supporting, angle and dead-end H-frames will be guyed.</li> <li>• Number of poles per H-frame: Tangent and small angle H-frame structures will require two poles per structure. Medium and large angle structures as well as dead-ends will require three poles per structure.</li> <li>• Structure heights: variable between 57 to 75 feet.</li> <li>• Approximate span distance between structures: 400-1,200 feet.</li> <li>• ROW width: nominal 125 feet.</li> <li>• Conductors: non-specular finish.</li> <li>• Two EHS steel overhead ground wires with a diameter of 0.375 inch.</li> <li>• Minimum ground clearance: 27 feet.</li> <li>• Line length: 0.9 mile.</li> <li>• The final quantity, heights, span lengths, and clearances provided by the structures and ROW widths will depend on the final detailed design of the transmission line.</li> </ul>

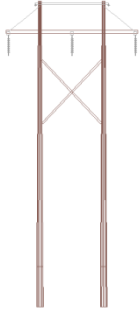

Facility	Description
<p data-bbox="203 235 488 394">Single-Circuit 138-kV Transmission Line (Applicable to 138-kV rebuilding portion of Proposed Route)</p> 	<ul style="list-style-type: none"> <li>• Proposed structure type: Wood-pole H-frame structures. Tangent H-frame structures are self-supporting, angle and dead-end H-frames will be guyed.</li> <li>• Number of poles per H-frame: Tangent and small angle H-frame structures will require two poles per structure. Medium and large angle structures as well as dead-ends will require three poles per structure.</li> <li>• Structure heights: variable between 51 to 61 feet.</li> <li>• Approximate span distance between structures: 500-750 feet.</li> <li>• ROW width for: nominal 100 feet.</li> <li>• Conductors: one conductor per phase.</li> <li>• Conductor Spacing: typical vertical spacing of 5.5 feet between shield wire and 138-kV phase wires, 13.5 feet horizontal spacing between phase wires.</li> <li>• Shield Wire: Two OHGW consisting of EHS steel and having a diameter of 0.375 inch.</li> <li>• Minimum design ground clearance: 30 feet.</li> <li>• Line length: Approximately 1.1 miles.</li> <li>• The final quantity, heights, span lengths, and clearances provided by the structures and ROW widths will depend on the final detailed design of the transmission line.</li> </ul>

EHS – extra high strength; OHGW – overhead ground wire; OPGW – optical ground wire; ROW – right-of-way

### 3.5 Information Required for Transmission Line Projects

#### 3.5.1 Transmission Line Length

OAR 345-021-0010(1)(b)(E)(i): The length of the pipeline or transmission line.

The Project is an approximately 272.8-mile-long, electric transmission line consisting of:

- New construction of 270.8 miles of single-circuit 500-kV electric transmission line,
- Removal of 12 miles of existing 69-kV transmission line,
- Rebuilding of 0.9 mile of a 230-kV transmission line, and
- Rebuilding of 1.1 miles of an existing 138-kV transmission line.

IPC also proposes four alternatives totaling 33.3 additional miles.

#### 3.5.2 Proposed ROW Width

OAR 345-021-0010(1)(b)(E)(ii): The proposed right-of-way width of the pipeline or transmission line, including to what extent new right-of-way will be required or existing right-of-way will be widened.

The Site Boundary for the transmission line is 500 feet wide. IPC may locate the transmission line ROW anywhere within the Site Boundary. The typical ROW width for the 500-kV portion of the Project will be 250 feet. In forested areas, the ROW width may extend up to 300 feet to allow for maintenance of danger trees, while in other areas the ROW width will be narrower to

facilitate avoidance of resources or land owner or agency requests. Specific areas where the ROW width will vary include the following:

- While crossing the NWSTF Boardman, the 500-kV line will use approximately 12 miles of the existing 69-kV line 90-foot ROW. The existing 90-foot ROW will not be widened.
- The new ROW width for the single-circuit 230-kV rebuild portion will be up to 125 feet. The 0.9 miles of the existing 230-kV ROW will be widened to 250 feet to facilitate placement of the 500-kV line.
- The new ROW width for the 1.1 miles of 138-kV rebuild will be 100 feet. The 1.1 miles of the existing 138-kV ROW will be widened from 100 feet to 250 feet to accommodate placement of the 500-kV line.

The ROW width for Project roads will vary between 10 and 14 feet. For new primitive roads, the ROW width will be 10 feet. For new bladed roads, the ROW will be 14 feet. For existing roads both with and without substantial modification, the ROW width will be 14 feet. In areas of steep terrain, the ROW width for roads may need to be wider (up to 35 feet).

The site specific required ROW width will be determined and finalized during the final design of the Project.

### 3.5.3 *Where Following Public ROW*

OAR 345-021-0010(1)(b)(E)(iii): If the proposed transmission line or pipeline corridor follows or includes public right-of-way, a description of where the transmission line or pipeline would be located within the public right-of-way, to the extent known. If the applicant proposes to locate all or part of a transmission line or pipeline adjacent to but not within the public right-of-way, describe the reasons for locating the transmission line or pipeline outside the public right-of-way. The applicant must include a set of clear and objective criteria and a description of the type of evidence that would support locating the transmission line or pipeline outside the public right-of-way, based on those criteria.

In many locations, the Project is located adjacent to existing public ROWs; however, the Project is too large to be located entirely *within* existing public ROWs (see Section 3.1.1.2, Opportunities, for a discussion of where IPC explored existing ROWs as siting opportunities). All portions of the Project will be located in private ROWs or new ROW grants or special use authorizations on public land except to the extent the corridor must cross existing public ROWs.

### 3.5.4 *Pipeline Operating Pressure and Delivery Capacity*

OAR 345-021-0010(1)(b)(E)(iv): For pipelines, the operating pressure and delivery capacity in thousand cubic feet per day and the diameter and location, above or below ground, of each pipeline.

The Project does not involve a pipeline. OAR 345-021-0010(1)(b)(E)(iv) is not applicable.

### 3.5.5 *Rated Voltage, Load Carrying Capacity Current and Structures*

OAR 345-021-0010(1)(b)(E)(v): For transmission lines, the rated voltage, load carrying capacity, and type of current and a description of transmission line structures and dimensions.

**Rated voltage** – 500 kV.

**Operating voltage** – IPC will operate the Project between 535 kV and 550 kV.

**Load carrying capacity** – The Project, a single-circuit 500-kV line, will have a thermal continuous rating of about 3,000 MW. Due to reliability standards and the WECC’s rating process, the initial implementation of the facility is likely to result in a bidirectional rating of 1,400 MW. In total, the transfer capability of the Idaho to Northwest path will increase by 1,050 MW from west to east (imports into IPC’s balancing authority area). When coupled with other projects under development, the transfer capability of the Idaho to Northwest path will increase by 1,000 MW from east to west (exports into the Pacific Northwest).

**Type of Current** – AC.

Transmission line structures and dimensions are described in Section 3.2.2 above.

### 3.6 Construction Schedule

OAR 345-021-0010(1)(b)(F): A construction schedule including the date by which the applicant proposes to begin construction and the date by which the applicant proposes to complete construction. Construction is defined in OAR 345-001-0010. The applicant shall describe in this exhibit all work on the site that the applicant intends to begin before the Council issues a site certificate. The applicant shall include an estimate of the cost of that work. For the purpose of this exhibit, “work on the site” means any work within a site or corridor, other than surveying, exploration or other activities to define or characterize the site or corridor, that the applicant anticipates or has performed as of the time of submitting the application.

The station expansion construction and the communication station work will begin on a schedule that will allow for completion at approximately the same timeframe as the transmission line. Construction activity will begin within 3 years of the effective date of the site certificate, and construction will be completed within 7 years of the effective date of the site certificate. No work on the site as defined in OAR 345-001-0010 will take place before EFSC issues a Site Certificate.

### 3.7 Limitations on Use of the Right-of-Way (Second Amended Project Order Comments)

The Second Amended Project Order states that “[t]he application must explain in detail what limitations are placed on property owners in the transmission line right-of-way.” After the transmission line has been energized, agricultural and non-agricultural land uses that are compatible with safety regulations will be permitted in the ROW, subject to limitations. Limitations on uses include restrictions on placing buildings or structures within the ROW; restrictions on the use of equipment taller than 15 feet under the transmission line or around towers except as noted below; restrictions on crops that can grow to over 15 feet at maturity (such as timber) within 25 feet of the outermost phase conductor; restrictions on storage of flammable materials of any kind on the ROW; restrictions on refueling equipment under the transmission line; restrictions on grading, land recontouring, and material stockpiling under the transmission line or near structure locations; and required coordination with IPC for the construction of fences, irrigation lines, or other facilities that could be subject to induced current and for the use of agricultural equipment taller than 20 feet (see Exhibit K, Attachment K-1, Agricultural Lands Assessment; Exhibit P1, Attachment P1-4, Vegetation Management Plan; Exhibit AA, Electric and Magnetic Fields; and Attachment B-5 of this Exhibit, Road Classification Guide and Access Control Plan] for additional discussions regarding land uses within the ROW).

### 3.8 Areas of the Site Boundary Where Surveys Have Been Completed

Between the spring of 2011 and the summer of 2016, IPC conducted field surveys of the Project Site Boundary for wetlands, waters of the state, and cultural resources. IPC conducted the field surveys only on those areas where the landowner granted access and not on areas to which access had been denied or where sites could not be accessed due to safety or timing restrictions with landowners. Further, access granted by landowners differed for each type of resource survey. Some landowners allowed surveys on their lands for wetlands and waters of the state, but not for cultural resources; others allowed the opposite. In some instances, access was revoked by the landowner after one of the surveys had been completed, but not the other. For these reasons, portions of the Site Boundary have been surveyed for some resources, but not others. Mapbooks showing which portions of the Site Boundary have, and have not, been surveyed for each resource are included in Attachment B-7a (Wetland and Water Resources) and Attachment B-7b (Cultural Resources). The mapbooks do not identify the location of wetlands, waters of the state, or cultural resources—the location of those resources can be found in Exhibit J (wetland and water resources) and Exhibit S (cultural resources).

## 4.0 CONCLUSIONS

Exhibit B includes the application information required by OAR 345-021-0010(1)(b). The project description provides sufficient detail for members of the public and reviewing agencies to make informed comments, and it includes sufficient explanation of how the Proposed Corridor and alternative corridor segments were chosen and consideration of the siting factors under OAR 345-021-0010(1)(b)(D) as well as the analysis required by ORS 215.275.

## 5.0 COMPLIANCE CROSS-REFERENCES

Table B-14 identifies the location within the ASC of the information responsive to the application submittal requirements in OAR 345-021-0010(1)(d) and the relevant Second Amended Project Order provisions.

**Table B-14. Compliance Requirements and Relevant Cross-References**

Requirement	Location
<b>OAR 345-021-0010(1)(b)</b>	
(b) Exhibit B. Information about the proposed facility, construction schedule and temporary disturbances of the site, including:	All sections
(A) A description of the proposed energy facility, including as applicable:	Exhibit B, Section 3.2
(i) The nominal electric generating capacity and the average electrical generating capacity, as defined in ORS 469.300.	Exhibit B, Section 3.2.1
(ii) Major components, structures and systems, including a description of the size, type and configuration of equipment used to generate electricity and useful thermal energy.	Exhibit B, Section 3.2.2
(iii) A site plan and general arrangement of buildings, equipment and structures.	Exhibit B, Section 3.2.3
(iv) Fuel and chemical storage facilities, including structures and systems for spill containment.	Exhibit B, Section 3.2.4
(v) Equipment and systems for fire prevention and control.	Exhibit B, Section 3.2.5
(vi) For thermal power plants.	Not Applicable

Requirement	Location
(vii) For surface facilities related to underground gas storage, estimated daily injection and withdrawal rates, horsepower compression required to operate at design injection or withdrawal rates, operating pressure range and fuel type of compressors.	Not Applicable
(viii) For facilities to store liquefied natural gas, the volume, maximum pressure, liquefaction and gasification capacity in thousand cubic feet per hour.	Not Applicable
(B) A description of major components, structures and systems of each related or supporting facility.	Exhibit B, Section 3.3
(C) The approximate dimensions of major facility structures and visible features.	Exhibit B, Section 3.4
(D) If the proposed energy facility is a pipeline or a transmission line or has, as a related or supporting facility, a transmission line or pipeline that, by itself, is an energy facility under the definition in ORS 469.300, a corridor selection assessment explaining how the applicant selected the corridor(s) for analysis in the application. In the assessment, the applicant shall evaluate the corridor adjustments the Department has described in the project order, if any. The applicant may select any corridor for analysis in the application and may select more than one corridor. However, if the applicant selects a new corridor, then the applicant must explain why the applicant did not present the new corridor for comment at an informational meeting under OAR 345-015-0130. In the assessment, the applicant shall discuss the reasons for selecting the corridor(s), based upon evaluation of the following factors:	Exhibit B, Section 3.1 and Section 3.1.1 through Section 3.1.5
(i) Least disturbance to streams, rivers and wetlands during construction.	Exhibit B, Section 3.1.6
(ii) Least percentage of the total length of the pipeline or transmission line that would be located within areas of Habitat Category 1, as described by the Oregon Department of Fish and Wildlife.	Exhibit B, Section 3.1.6
(iii) Greatest percentage of the total length of the pipeline or transmission line that would be located within or adjacent to public roads and existing pipeline or transmission line rights-of-way.	Exhibit B, Section 3.1.6
(iv) Least percentage of the total length of the pipeline or transmission line that would be located within lands that require zone changes, variances or exceptions.	Exhibit B, Section 3.1.6
(v) Least percentage of the total length of the pipeline or transmission line that would be located in a protected area as described in OAR 345-022-0040.	Exhibit B, Section 3.1.6
(vi) Least disturbance to areas where historical, cultural or archaeological resources are likely to exist.	Exhibit B, Section 3.1.6
(vii) Greatest percentage of the total length of the pipeline or transmission line that would be located to avoid seismic, geological and soils hazards.	Exhibit B, Section 3.1.6
(viii) Least percentage of the total length of the pipeline or transmission line that would be located within lands zoned for exclusive farm use.	Exhibit B, Section 3.1.6
(E) If the proposed energy facility is a pipeline or transmission line or has, as a related or supporting facility, a transmission line or pipeline of any size:	Exhibit B, Section 3.5

Requirement	Location
(i) The length of the pipeline or transmission line.	Exhibit B, Section 3.5.1
(ii) The proposed right-of-way width of the pipeline or transmission line, including to what extent new right-of-way will be required or existing right-of-way will be widened.	Exhibit B, Section 3.5.2
(iii) If the proposed transmission line or pipeline corridor follows or includes public right-of-way, a description of where the transmission line or pipeline would be located within the public right-of-way, to the extent known. If the applicant proposes to locate all or part of a transmission line or pipeline adjacent to but not within the public right-of-way, describe the reasons for locating the transmission line or pipeline outside the public right-of-way. The applicant must include a set of clear and objective criteria and a description of the type of evidence that would support locating the transmission line or pipeline outside the public right-of-way, based on those criteria.	Exhibit B, Section 3.5.3
(iv) For pipelines, the operating pressure and delivery capacity in thousand cubic feet per day and the diameter and location, above or below ground, of each pipeline.	Exhibit B, Section 3.5.4
(v) For transmission lines, the rated voltage, load carrying capacity, and type of current and a description of transmission line structures and dimensions.	Exhibit B, Section 3.5.5
(F) A construction schedule including the date by which the applicant proposes to begin construction and the date by which the applicant proposes to complete construction. Construction is defined in OAR 345-001-0010. The applicant shall describe in this exhibit all work on the site that the applicant intends to begin before the Council issues a site certificate. The applicant shall include an estimate of the cost of that work. For the purpose of this exhibit, "work on the site" means any work within a site or corridor, other than surveying, exploration or other activities to define or characterize the site or corridor, that the applicant anticipates or has performed as of the time of submitting the application.	Exhibit B, Section 3.6
<b>Second Amended Project Order</b>	
The description of the proposed facility in the application will form the basis for the description of the facility in the site certificate. The site certificate will require that IPC build the facility "substantially as described." Exhibit B will also provide the basis for the facility description in the notice of application that ODOE will issue to reviewing agencies and public. Therefore, Exhibit B shall describe the facility in enough detail for members of the public and reviewing agencies to make informed comments. Exhibit B shall describe the facility sufficiently for ODOE staff to verify that the constructed project will meet any representations that are the basis for findings of compliance with applicable regulations for standards. It is recommended IPC not include descriptive material that IPC would not want to be held to in a site certificate condition.	Exhibit B, Section 3.2 through Section 3.6
The application must clearly describe the width of the corridor in which the micro-siting corridor right-of-way would be sited along the length of the proposed line. The application must specify the width of the permanent right-of-way IPC will request, and must justify that width.	Exhibit B, Section 3.2.2 and Section 3.5.2

Requirement	Location
The application shall describe all related or supporting facilities that the applicant proposes to be included in and governed by the site certificate, including proposed multiple use areas, fly yards, and access roads. For existing roads or road segments that will be included as related or supporting facilities, include a general description of the proposed modifications and improvements. For multiple use areas and fly yards, include a description of the activities that are expected to occur at these areas.	Exhibit B, Section 3.3
The alternatives analysis described in section OAR 345-021-0010(1)(b)(D) must be consistent with the analysis required by ORS 215.275 and the required information in this rule. The Council recognizes that some of the factors in this rule compete with one another (for example, the requirements to both avoid habitat and avoid agricultural land), but expects the application to demonstrate that all required factors were considered.	Exhibit B, Section 3.1, Sections 3.1.1 through 3.1.4, and Exhibit K, Section 4

## 6.0 RESPONSE TO NOTICE OF INTENT AND SCOPING MEETING COMMENTS

ODOE received over 450 comments based on the NOI and the related scoping meetings. ODOE summarized those comments in the First Amended Project Order (December 2014) and then removed the summaries from the Second Amended Project Order “to reduce the risk of misinterpreting the intention of the individual comment.”<sup>17</sup> Although ODOE eliminated the requirement that IPC address the comment summaries, IPC nonetheless voluntarily addresses those summaries here in Table B-15, identifying the location within the ASC of the information responsive to the comments summarized in the First Amended Project Order.

**Table B-15. Responses to Comment Summaries**

Comments	Location
<b>Not Directly Related to an EFSC Standard.</b> Commenters expressed many concerns about specific corridors proposed in the NOI. The Department understands that the corridor proposed in the Preliminary ASC might differ from that ultimately proposed in the Final ASC, but the applicant should ensure that the corridor selection analysis is included in Exhibit B.	Exhibit B, Section 3.1, and Attachment B-1 through Attachment B-6

## 7.0 REFERENCES

BLM (United States Department of Interior, Bureau of Land Management). 2002. Southeastern Oregon Resource Management Plan and Record of Decision. Vale Field Office, Vale Oregon.

DOE and BLM (lead agencies). 2008. Programmatic Environmental Impact Statement for the Designation of Energy Corridors on Federal Land in the 11 Western States (DOE/EIS-0386). November. Available online at <http://corridoreis.anl.gov/index.cfm>

IEEE (Institute of Electrical and Electronics Engineers). 2011. 2012 National Electrical Safety Code. August 1. ISBN: 9780738165882.

<sup>17</sup> Second Amended Project Order, Section VI(a).

IPC (Idaho Power Company). 2013. 2013 Integrated Resource Plan. September. Available online at: <http://www.idahopower.com/pdfs/AboutUs/PlanningForFuture/irp/2013/2013IRP.pdf>

IPC. 2015. 2015 Integrated Resource Plan. October. Available online at: <http://www.idahopower.com/pdfs/AboutUs/PlanningForFuture/irp/2015/2015IRP.pdf>

ODEQ (Oregon Department of Environmental Quality). 2003. Oregon Natural Hazards Mitigation Plan. Revised August 19. Available online at: <http://www.deq.state.or.us/aq/burning/wildfires/neap/appendixD.pdf>

ODFW (Oregon Department of Fish and Wildlife). 2011. *Greater Sage-Grouse Conservation Assessment and Strategy for Oregon: A Plan to Maintain and Enhance Populations and Habitat*. Oregon Department of Fish and Wildlife. Primary author Chris Hagen. April 22. Available online at: [http://www.dfw.state.or.us/wildlife/sagegrouse/docs/20110422\\_GRSO\\_April\\_Final%2052511.pdf](http://www.dfw.state.or.us/wildlife/sagegrouse/docs/20110422_GRSO_April_Final%2052511.pdf)

OSFM (Oregon State Police – Oregon Office of State Fire Marshal). 2007. “Conflagration FAQs: What is the Conflagration Act?” [Internet]. Available online at: [http://www.oregon.gov/OSP/SFM/Pages/Conflagration\\_Information\\_2007.aspx](http://www.oregon.gov/OSP/SFM/Pages/Conflagration_Information_2007.aspx)

USFS (United States Forest Service). 1990. Wallowa-Whitman National Forest Land and Resource Management Plan. April. Available online at <http://www.fs.usda.gov/detail/wallowa-whitman/landmanagement/planning/?cid=stelprdb5259879>.