

Seismic Vulnerability of Oregon State Highway Bridges

Mitigation

Strategies to
Reduce Major Mobility

Risks



Oregon
Department of
Transportation



SEISMIC VULNERABILITY OF OREGON STATE HIGHWAY BRIDGES

Mitigation Strategies To Reduce Major Mobility Risks

Oregon Department of Transportation
Bridge Engineering Section
November 2009

Table of Contents



SEISMIC VULNERABILITY OF OREGON STATE HIGHWAY BRIDGES

Mitigation Strategies To Reduce Major Mobility Risks

Executive Summary 6

Background 8

Development Of ODOT Seismic Design Standards 13

Current ODOT Seismic Design Philosophy 17

Previous Studies 25

Highway Bridge Inventory 25

Early Seismic Vulnerability Studies 27

Cascadia Peril 2009 Exercise Model 29

Highway Mobility Impacts From Simulated Seismic Events 33

Bridge Seismic Vulnerability Assessment of the Network 33

Earthquake Scenarios 34

Bridge Damage States 36

Incorporation of the Transportation Network 37

Estimate of Economic Impact 38

Oregon Seismic Network Model 41

Study Area 41

State Earthquake Scenarios Used in Analysis 43



Crustal Earthquake Scenarios in the Portland Metro Area 44

Crustal Earthquake Scenarios in the Scotts Mills Area 45

Crustal Earthquake Scenarios in the Klamath Falls Area 45

Cascadia Subduction Zone Earthquake near Southern Oregon 46

Cascadia Subduction Zone Earthquake near Northern Oregon 46

Full Length Cascadia Subduction Zone Earthquake 47

ODOT Seismic Mitigation Strategies 51

Current Retrofit Strategy and Summary of Progress 51

Recommendations 57

References 58

Appendix A

Additional Notes on REDARS 2 Model 59

Study Limitations 60

EXECUTIVE SUMMARY

Hundreds of Oregon bridges remain vulnerable to earthquake damage. Although 15-20 earthquakes of magnitude $M > 3.0$ are felt each year in the Pacific Northwest, modern Seismic Design Specifications were not available or used for bridge design until early 1990.

With a majority of state owned bridges designed and built between 1950 and 1980, the state of Oregon would face a devastating post earthquake situation if a major event occurred in the state. The Oregon Department of Transportation (ODOT) has begun a study to define the magnitude of the problem by evaluating the vulnerability of state highway bridges in western Oregon. This report is intended to be a first step in a comprehensive look at seismic risk to transportation systems that could include slides, fill slopes, local roads and bridges, and supply lines, such as fuel depots, electricity, water and sewer lines.

This report marks the culmination of two years of study jointly conducted by ODOT and Portland State University. The study makes use of a computer program called REDARS2 that simulates damage to bridges within a transportation network. It can predict ground motions for a specific location and magnitude of earthquake, resulting bridge damage and the cost of the damage, as well as the cost to the public for traffic delays due to detours around damaged bridges. Estimated damage and delay costs are presented for major highways in Western Oregon, where most of the earthquake damage is predicted to occur.

Research and analysis were done to identify the most vulnerable highway segments of the state highway system and to select appropriate earthquake scenarios. This report, "Seismic Vulnerability of Oregon State Highway Bridges, Mitigation Strategies to Reduce Major Mobility Risks", describes potential damage to State highway bridges from six representative earthquake scenarios that are thought most likely to occur in Oregon. The study found that highway mobility would be severely reduced after a major Cascadia Subduction Zone event, as well as after a significant crustal earthquake. US 101 would have dozens of failures that would be impassable due to bridge collapses.

All of the existing highways that connect US 101 to I-5 would be impassable due to bridge collapse and major damage. Small segments of I-5 would be useable because a number of those bridges have been replaced since 1990, including many in the OTIA III Program, but many older, obsolete overpasses would collapse and block the through lanes, and many older river crossings would be impassable. Some essential services that depend on the Willamette River crossings in Portland would be affected as well.

The report also considers possible mitigation, including bridge retrofit and strengthening to withstand seismic damage. However, current available highway funding is inadequate to achieve a minimum standard of seismic safety even on the Interstate and other critical routes. Further research is needed before the State can fully realize the benefits of the analysis done so far to establish the highest priority for retrofit using the limited Bridge Program funding. It would be very useful in developing a coordinated mitigation program if a comprehensive study of seismic vulnerability and risk for the entire transportation system was conducted. The goal of such a study would be to define an overall perspective on resulting mobility impacts and loss of basic, critical supply lines after a major seismic event. This comprehensive study is needed to correctly identify and program vital bridges for Phase 1 or Phase 2 seismic retrofits, or replacement of these bridges with seismically adequate structures to ensure that access to critical facilities is maintained.

ODOT will continue to work with highway stakeholders to refine the plans for possible mitigation and emergency response when an earthquake hits. The report also recommends that further study be conducted to update existing lifeline route designations to be consistent with new bridges built in the last fifteen years since the original routes were identified and to ensure access is maintained to critical supplies and facilities. Although much work remains to be done and many future decisions made, we believe this report represents a major milestone. It is a significant contribution that highlights a pressing need for the current and future safety of Oregon's highway system.

BACKGROUND

In the past, Oregon was considered to be a region of relatively low seismicity and earthquake occurrence. Very few strong earthquakes ($M > 6.0$) have ever been recorded in Oregon even though many smaller earthquakes occur each year. Reference is often made to the more frequent occurrence of large earthquakes in both Washington and California. However, the recorded history of Oregon is accurately documented for a period of only about 150 years; a very short period of time in geologic terms. About 25 years ago, paleoseismic studies and other geologic research began to be conducted that resulted in support for the theory that major seismic events have occurred, and will continue to occur, in Oregon. Geologic evidence has been discovered and presented by several researchers supporting the likelihood of large subduction zone earthquakes, with magnitudes greater than 8.0, occurring in the future somewhere along the Oregon coast. Other geologic evidence has been discovered which supports a high probability of strong crustal earthquakes occurring in several areas throughout Oregon. Shallow crustal earthquakes are known to occur routinely throughout the western part of the state. In 1993, three notable crustal earthquakes occurred in Oregon; Scotts Mills (5.6 magnitude) and Klamath Falls quakes (5.9 and 6.0 magnitude). The total damage cost resulting from these events was about \$40 million and included two fatalities.

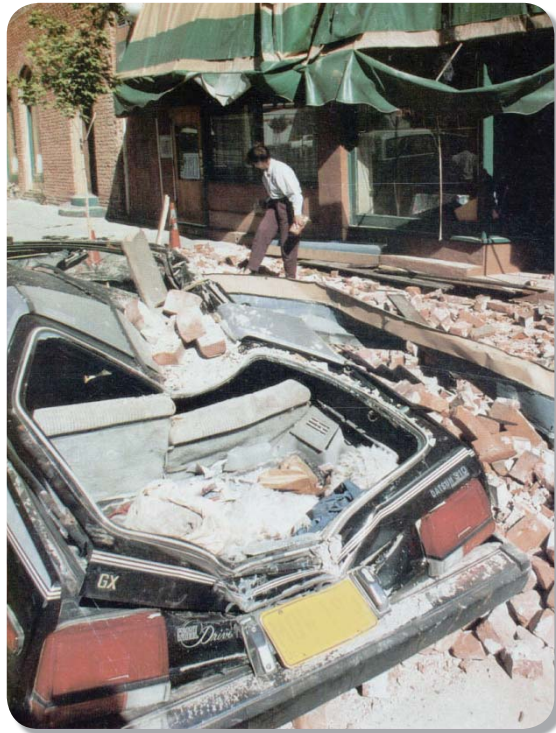

Figure 1.1 : Partial wall and parapet collapse, Klamath Falls, Oregon earthquake; Source: Earthquakes and Volcanoes, Vol. 24, No. 3, 1993

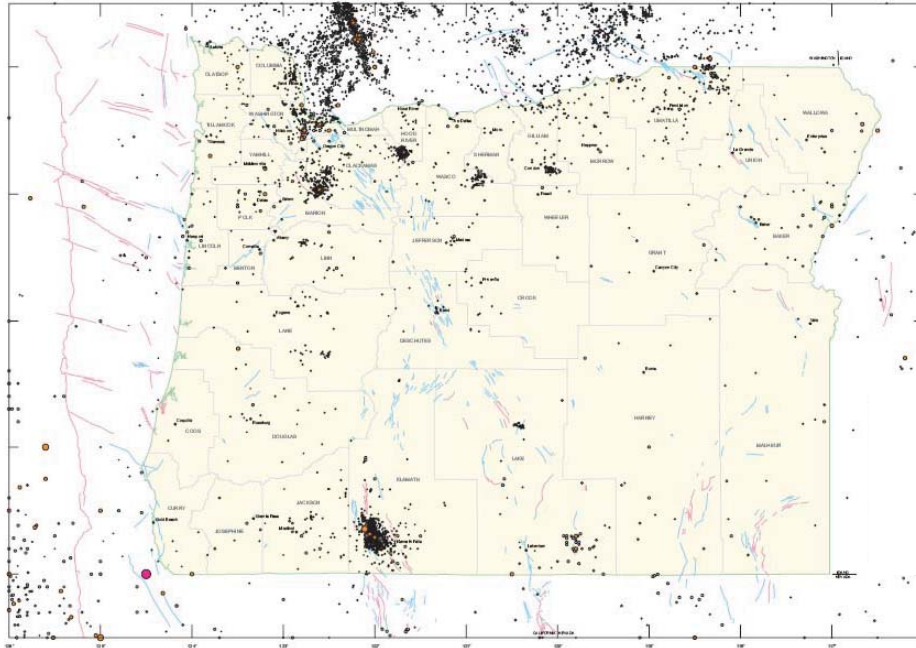
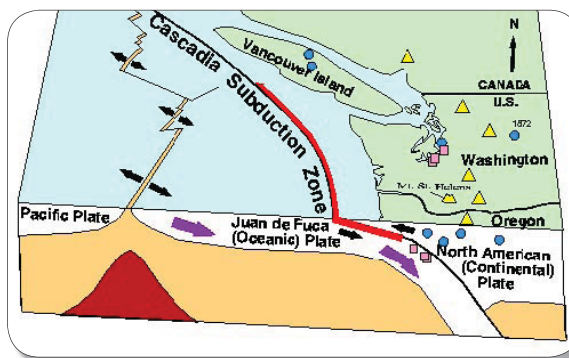

Figure 1.2: Map of selected earthquakes for Oregon (1841–2002) (over 14,000 earthquakes shown); Source: Oregon Department of Geology and Mineral Industries, Open File Report O-03-02

As shown in Figure 1.2, earthquakes less than about M 6.0 occur routinely throughout Oregon. Most of these instrumentally recorded earthquakes have magnitudes less than 4.0 and very few significant historical earthquakes have been recorded east of the Cascade Range. Nearly 17,000 earthquakes of magnitude 1.0 to 6.0 have been recorded in Oregon and Washington since 1970. About 15–20 earthquakes a year are felt in the Pacific Northwest (M>3.0).

Figure 1.3: Cascadia Subduction Zone plate boundary; Source: Pacific Northwest Seismic Network, University of Washington



The west coast of Oregon is located along the western margin of the North American tectonic plate near the boundary of the Juan de Fuca plate (Figure 1.3). Relative plate motions result in the Juan de Fuca plate sinking

below the North American plate along the Cascadia Subduction Zone (CSZ) and beneath the coast of Northern California, Oregon, Washington and British Columbia. The North American plate is also deforming as it accommodates strain along its boundaries with the Pacific and Juan de Fuca plates. While earthquakes along this zone occur infrequently, plate movement can produce major earthquakes. In addition, western Oregon is underlain by a large and complex system of faults that can also produce damaging earthquakes. These smaller faults produce lower magnitude events, but the ground shaking and damage from these events can be great to structures located nearby.

Tectonic plate interactions result in the creation of faults and folds that generate most of the large earthquakes in the Pacific Northwest. Based on plate tectonic models and historical observations, major earthquakes in the Pacific NW that would affect Oregon bridges have three principal origins as described below and depicted in *Figure 1.4*:

1. Subduction Zone Interplate thrust earthquakes. These are very large earthquakes originating at the boundary of the North American and Juan de Fuca plates, (e.g. M_w 9 on Jan. 26, 1700)
2. Deep (25-45 miles) Intraplate earthquakes resulting from internal stresses associated with the bending and arching of the Juan de Fuca plate as it is subducted beneath the North American plate. (e.g. Feb. 28, 2001, M_w 6.8 Nisqually earthquake)
3. Shallow crustal earthquakes (<12 miles) generated within the different seismotectonic provinces in the overlying North American plate. (e.g. Mar. 25, 1993, M_L 5.7 Scotts Mills earthquake)

Figure 1.4: Principal earthquake sources for major earthquake in Oregon; Source: Shoreland Solutions. Chronic Coastal Natural Hazards Model Overlay Zone, Salem, OR: Oregon Department of Land Conservation and Development (1998) Technical Guide-3

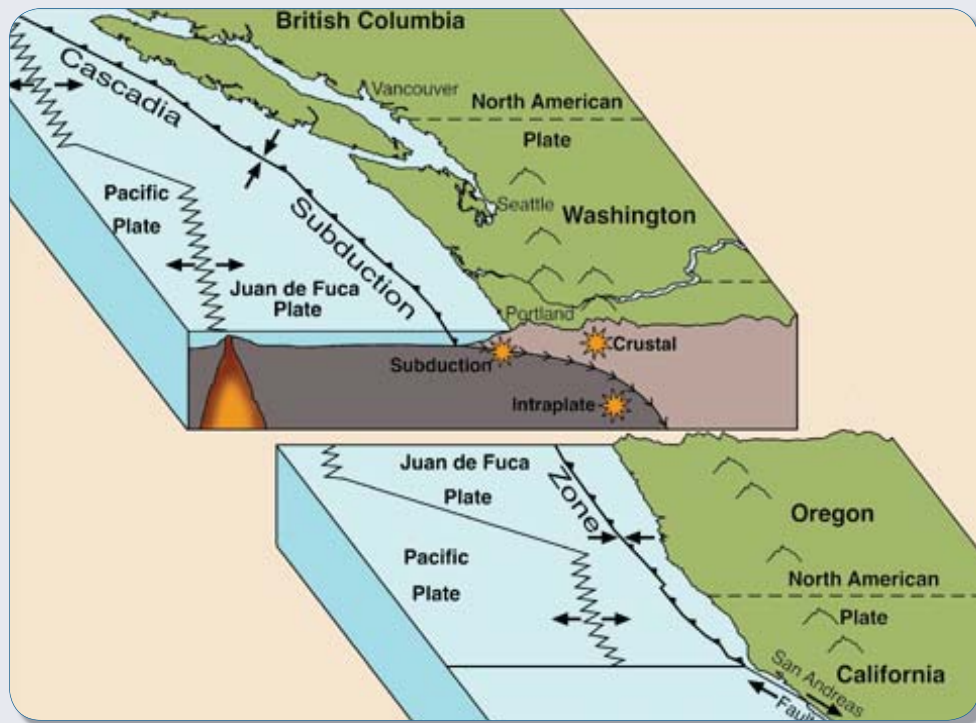

Geologists have indicated in recent years that the question is not if a catastrophic earthquake will occur in Oregon, but when one will occur. Evidence indicates that off the Oregon coast, Cascadia Subduction Zone earthquakes of magnitude 8.0 or greater have occurred on average about every 500 years, most recently in late January of 1700 A.D. Recent research by the Oregon Department of Geology and Mineral Industries (DOGAMI press release; Oregonian, April, 2009 ⁽¹⁾) indicates subduction zone earthquakes could occur on an average of every 300–350 years instead of about every 500 years and there’s a 40 percent chance a powerful earthquake will occur along the Oregon coast in the next 50 years (80 percent chance along the southern margin).

A map of Oregon showing all active faults is shown in *Figure 1.5*. Faults shown in red are the most recently active faults (younger than 10,000 years).

Figure 1.5: Fault map of Oregon; Source: Compiled by Robert Langridge of University of Oregon

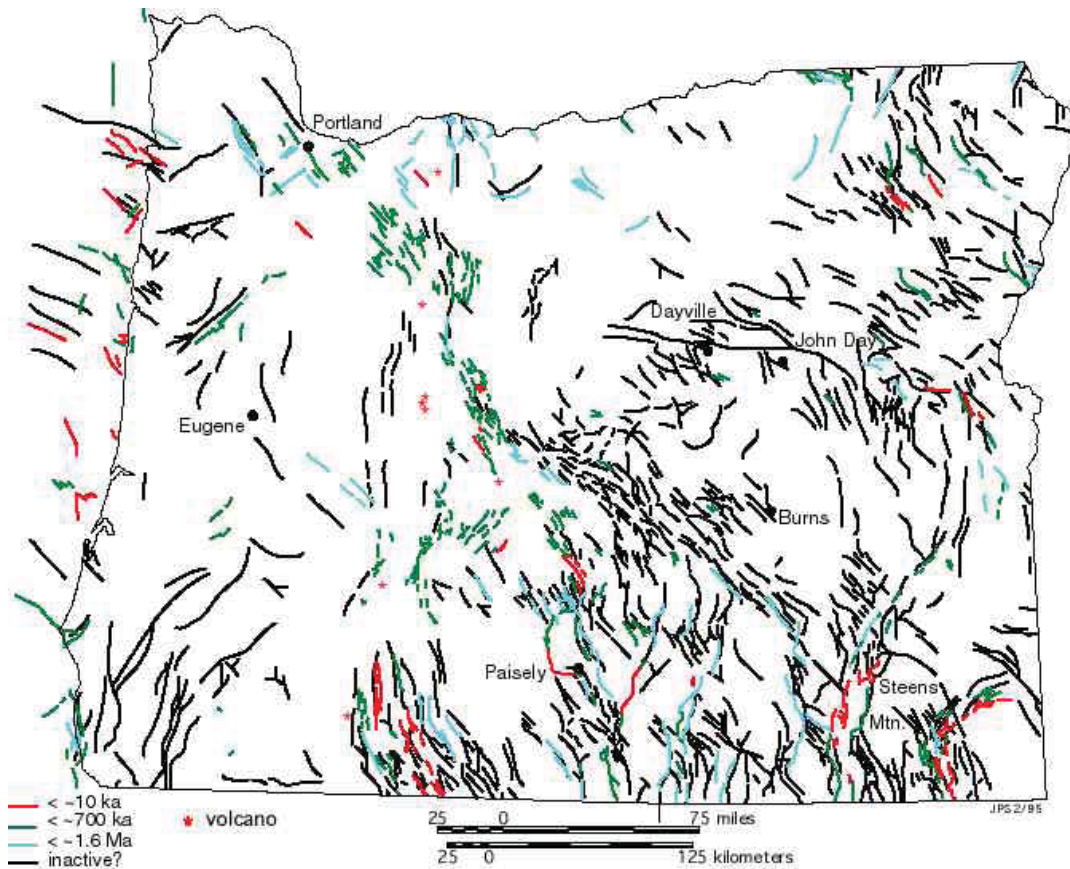

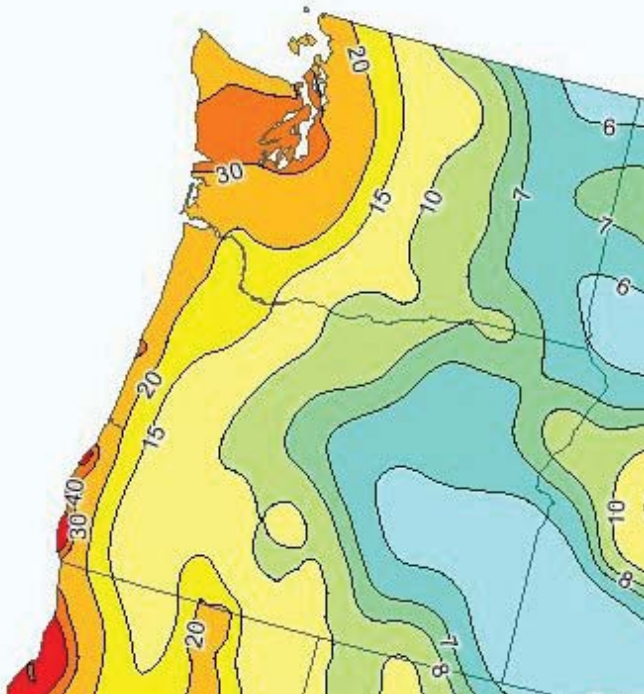

The current seismic hazard in Oregon is best represented by a seismic hazard map showing contours of peak ground acceleration. The United States Geological Survey (USGS) seismic hazard map shown in Figure 1.6 is a map currently in use by Oregon Department of Transportation (ODOT) for the seismic design of bridges. It can be seen from this map that the coast and most of the western portion of Oregon is in a relatively high seismic hazard area similar to that of Washington and California.

Figure 1.6 : Peak Horizontal Acceleration with 10% probability of exceedance in 50 years; Source: USGS 2002 Seismic Hazard Map

The following table provides a brief summary of the primary earthquake sources affecting Oregon, their approximate frequency of occurrence, range of magnitude and most recent activity.

Table 1.1 : Primary Earthquakes Affecting Oregon

Source	Magnitude	Frequency	Latest Occurrence
Crustal	M < 5.5	15 – 20/yr	Annually
	M ≥ 5.5	???	1993: Scotts Mills & Klamath Falls
CSZ*	M ≥ 8.0	Every 350–500 yrs	Jan., 1700
Intraplate	M = 4.0–7.0	Every 30–50 yrs	Feb., 2009: M4.1, Grants Pass, OR

* Cascadia Subduction Zone Interplate event

Oregon bridge sites are also vulnerable to damage because of their topography and geology. Soil profiles at many bridge sites are often prone to liquefaction during the shaking that would occur during an earthquake. Depending on the location of the epicenter of the earthquake, areas receiving major damage from an 8.0 – 9.0 magnitude subduction zone earthquake would include most of the counties in Western Oregon, including heavily populated metropolitan areas such as Portland, Salem, and Eugene.

DEVELOPMENT OF ODOT SEISMIC DESIGN STANDARDS

Prior to 1958, seismic loading was typically not considered in the design of bridges. From 1958–1974 all bridges were designed for a seismic force equal to 2%–6% of structure weight (.02g-.06g). In 1971, the San Fernando earthquake marked a major turning point in the seismic design of bridges and began the development of a new set of design criteria for bridges in the US. In 1975 the American Association of State Highway and Transportation Officials (AASHTO) adopted Interim Specifications which were based largely on design criteria developed by the California Department of Transportation (Caltrans) in 1973. These code provisions were used by ODOT from 1975–1990. They resulted in an increased seismic design force equal to 8%-12% of structure weight and the introduction of ductile reinforcing details (Refer to Section 3 for further discussion regarding ductile reinforcement).

In 1989, the Loma Prieta earthquake in northern California prompted ODOT to take a very close look at the overall seismic hazard in Oregon and the affects of this hazard on bridge design. During this time, several earthquake hazard studies were taking place and various researchers and agencies were investigating and uncovering new evidence of an increased level of seismic hazard in Oregon. Field evidence was discovered indicating that large subduction zone earthquakes had occurred along the Oregon coast regularly in the past and active crustal faults were discovered in many other areas of the state that were not previously accounted for in the standard seismic hazard maps in use at that time. These newly discovered sources indicated a much higher level of seismic risk to ODOT bridges than previously accounted for in many parts of the state. At this time a seismic hazard study was also being conducted by Washington State University (WSU) for the Washington Department of Transportation (WSDOT) ^[2], which resulted in an increase in seismic design ground motions for much of Washington State, above the values obtained from the AASHTO seismic design maps in use at that time. WSDOT adopted the results of this study for their use in seismic design. The area of this study extended into northern portions of Oregon, including Portland, and gave some insight into the potential increase in the seismic hazard in these areas.

In light of this new information, in 1990, ODOT decided to develop a statewide seismic design map of peak ground acceleration (PGA), based in part on the WSU report and also on recommendations from DOGAMI. This map was adopted for use in seismic design on an interim basis until a thorough study of the seismic hazard in Oregon could be completed. The PGA values on this interim map were significantly greater for much of the state than the values used before

from the AASHTO hazard map, most notably in the Portland metropolitan area and along the southern Oregon coast. Also at this time (1990), a new AASHTO guide specification for the seismic design of bridges was adopted by ODOT for use with the new interim ground motion map.

In 1991, ODOT contracted with an earthquake engineering consultant firm (Geomatrix, Inc.) to conduct a seismic hazard analysis of Oregon and develop new seismic hazard design maps specifically for use in ODOT bridge design. The resulting report ^[3] is an extensive study and compilation of all known active fault sources affecting Oregon and included the latest consensus on ground motion characteristics of the Cascadia Subduction Zone (CSZ). This report, titled "Seismic Design Mapping, State of Oregon", is still considered to be one of the most important references documenting the seismic hazard in Oregon. The seismic hazard maps produced in this report for a 500-year return event were adopted by ODOT in 1995 and used for seismic design until 2004. In 2004, ODOT decided to adopt the 2002 USGS seismic hazard maps which are similar in level of hazard to the Geomatrix maps that were already in use. Also at this time, ODOT adopted a 1000-year return event for use in design (higher seismic design level) which was later adopted by AASHTO as the standard level of design hazard nationwide.

Another source of bridge damage resulting from earthquake ground shaking is liquefaction of the foundation soils. Liquefaction occurs when loose, saturated, sandy soils are subjected to ground shaking caused by earthquakes. This shaking creates excess porewater pressure in the soil and the soil loses most of its strength. Liquefied foundation soils can settle and also cause large horizontal ground displacements (lateral spread) which can produce very large loads on bridge foundations, to the point of causing bridge collapse.



Figure 2.1 : Bridge pier damage resulting from liquefaction and lateral displacement of foundation soils (Yachiyo Bridge, 1964 Niigata, Japan)

Figure 2.1 is an example of bridge damage resulting from liquefaction of foundation soils. The effects of liquefaction on bridge performance was not accounted for in bridge design until about 1995 and mitigation of liquefaction damage potential was not included in routine bridge design until 2004. Therefore, bridges constructed before 1995 were not evaluated or designed for the effects of liquefaction or lateral spread. Bridges constructed between 1995 and about 2004 were evaluated for liquefaction potential, and if liquefaction was possible, these effects were partially incorporated into bridge design. However, sites with the potential of lateral spreading were typically not mitigated.

Beginning in 2004, liquefaction leading to lateral spreading were all evaluated including the need for designing and constructing mitigation measures if necessary.

Table 2.1 : A summary of the important events and changes made to the seismic design codes and ground motion hazard levels over time are presented.

Year	AASHTO Design Code	Ground Motion Hazard
Prior 1958	Seismic loading typically not considered	N/A
1958-1974	Bridges designed for seismic force equal to 2%-6% of structure weight	N/A
1971	San Fernando, CA Earthquake	
1975-1990	Bridges designed for seismic force equal to 8%-12% of structure weight based on adopted AASHTO Interim Specs.	1975: Seismic Hazard Maps first appear in AASHTO; (Oregon in Zones 1 & 2)
1989	Loma Prieta, CA Earthquake	
1990	Adopt 1983 AASHTO Seismic Design Guide	Adopt 1990 interim ODOT Seismic Specifications Hazard Map
1995		Adopt 500-yr. Geomatrix design hazard maps (includes subduction zone event)
2004	Include liquefaction effects into routine design	Adopt 2002 USGS hazard maps; Adopted 1000-yr base design event

Bridges located in the western portion of the state (west of the Cascade Range) or in the Klamath Falls area, constructed prior to 1975, are highly vulnerable with significant potential for damage and collapse. Bridges constructed between 1975 and 1995 in these areas are considered to have a moderate potential for damage or collapse. Bridges constructed after 1995 are much less vulnerable to damage or collapse since they were designed based on levels of ground shaking close to what is in use today and with much better design detailing. However, some of these bridges may still be vulnerable to significant damage or collapse if located in areas with liquefiable soils since liquefaction effects were not fully taken into account, or mitigated for, until about 2004. In 2004, ODOT adopted a higher level of design ground motion (1000-yr return event) for use in combination with the no-collapse (life safety) criteria and also began designing and mitigating for the effects of liquefaction on bridge performance. Bridges designed since 2004 are based on ground motions, structural analysis, design detailing and liquefaction effects that are consistent with current design standards.

The potential for structural collapse of bridges constructed during specific time periods, when subjected to earthquake forces, is shown in the table below. The bridge collapse potential reflects the design codes that were in effect during each given time period.

Table 2.2 : Structure collapse potential relative to year constructed

Year Constructed	Structure Collapse Potential
Prior to 1975	Significant
1975-1994	Moderate
1995-2004	Low
2004-present	Very Low

CURRENT ODOT SEISMIC DESIGN PHILOSOPHY

ODOT bridges are currently designed to at least meet the national bridge design standards established by AASHTO. This includes all standards related to seismic bridge design. Under these code requirements bridges are primarily designed to meet a life-safety performance standard, which means the bridge has a very low probability of collapse when subjected to earthquakes that are most likely to occur over the life of the structure.

The level of ground shaking used in the design is associated with earthquakes that on average could occur approximately every 1000 years. Even under the high level of shaking the bridge is designed for, it could likely suffer some amount of structural damage which would require repair. Like any natural event, an even larger earthquake could occur, resulting in larger movements than bridges are designed for. Bridge damage could be extensive enough to require complete replacement. This design philosophy is used because it would be too expensive to design bridges for the highest possible, but very rare, earthquakes.

ODOT seismic bridge design also includes a design check for a lower level earthquake event that occurs more frequently, on average approximately every 500 years. Under this lower level of shaking, the bridge is designed to withstand earthquake loads with minimal damage, such that the bridge can be opened to emergency traffic within 72 hours after an event. The inclusion of this additional lower level (“serviceability”) design is above the standard performance requirements prescribed by the AASHTO code.

Potential Damage And Failure Mechanisms

Ground shaking from earthquakes cause structures to also shake. For bridges, shaking occurs primarily in horizontal directions. This horizontal shaking and associated movement can cause damage to bridges.

A typical bridge is a combination of the following parts:

Figure 3.1 : Typical Bridge Components

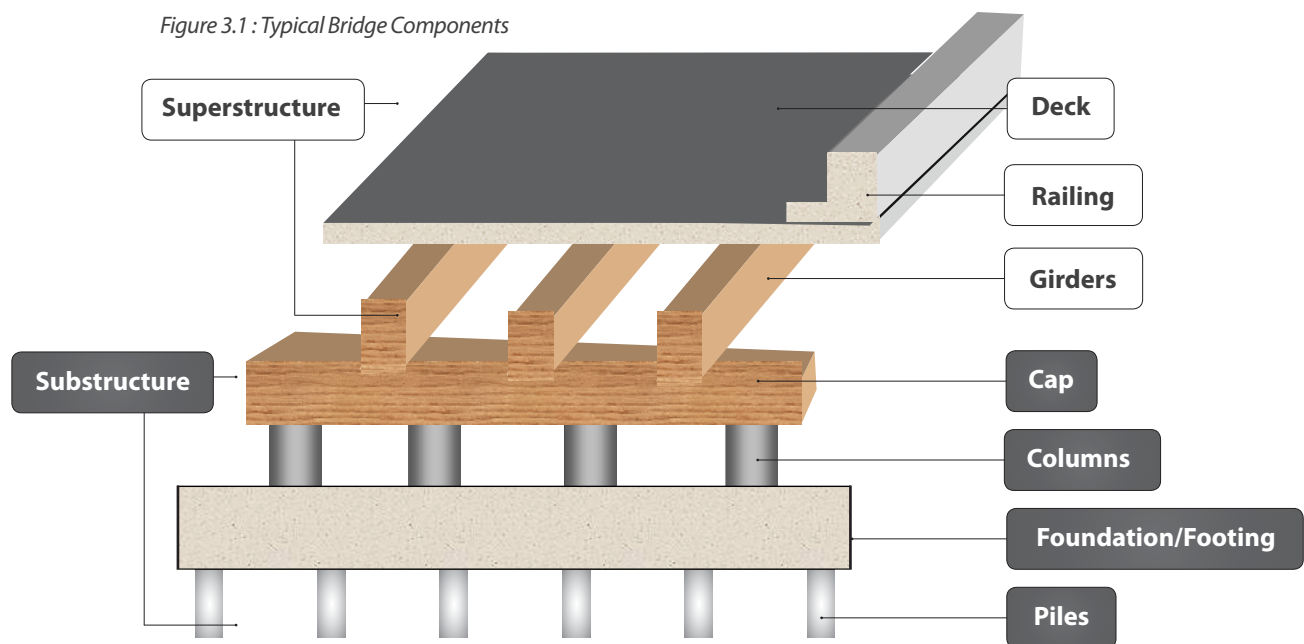

- **Deck** : The surface you drive on.
- **Railing** : Barrier at the edge of the deck.
- **Girders** : Members parallel to the roadway that support the deck.
- **Cap** : Members that support the girders.
- **Columns** : Vertical members that transfer loads from the cap to the foundation.
- **Foundation** : Members that transfer column loads into the ground. This generally includes a concrete footing that is either supported by the ground or supported by piling. Bridge ends (abutments) often do not have columns. For this case, the cap is connected directly to the footing and/or piling.
- **Piling** : Vertical members that transfer foundation (footing) loads into the ground. Piling normally extends down to a bedrock layer.

The deck, railing and girders together are called the “Superstructure”. All other elements (cap, columns, footings and piling) together are called the “Substructure.” The distinction between superstructure and substructure is important when considering potential damage from earthquakes and ways to retrofit a structure to avoid damage.

The horizontal movement from an earthquake typically does not do any damage to decks, railing or girders. These elements generally have robust connections between them which can easily accommodate horizontal earthquake forces. The connection between the superstructure and the substructure, however, is a major source of concern.

Bridge superstructure elements expand and contract (i.e., change length) with temperature changes as part of the normal bridge life. These movements are often accommodated by placing bearings underneath girders. These bearings provide a load transfer mechanism between the girders and cap. Bearings accommodate the large vertical loads (weight of the superstructure and vehicle loads) and transfer them from girders to cap, but also allow the small amount of horizontal movement that results from changes in temperature.

Figure 3.2: Rocker Bearings

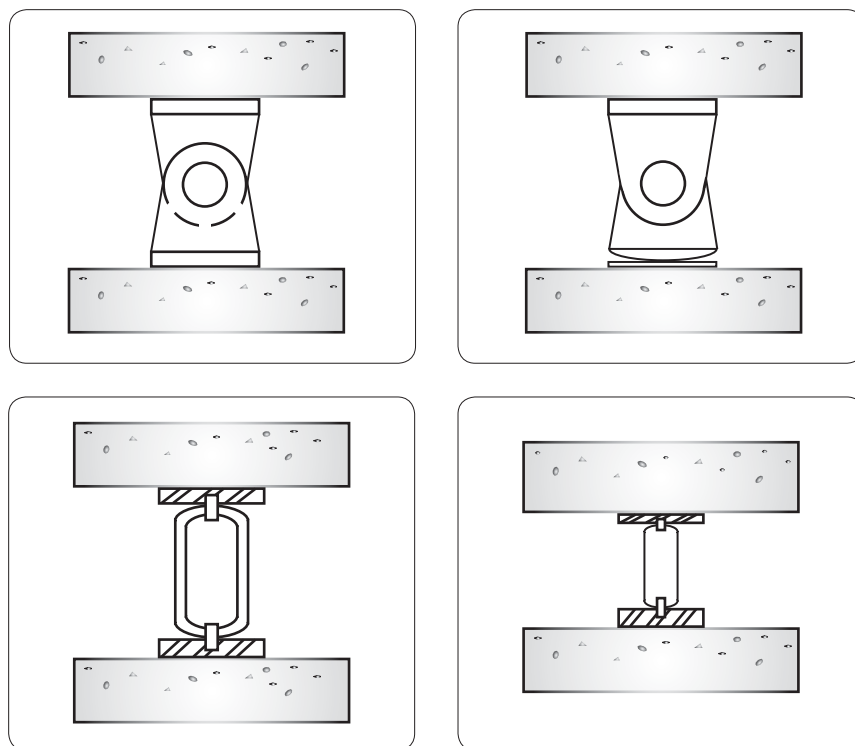

Although bearings are very good at accommodating temperature movements, they are often poor at resisting horizontal earthquake loads. In some cases, support for a bearing may be compromised if an earthquake causes excessive horizontal movement of a girder. In extreme cases, bearings can topple.

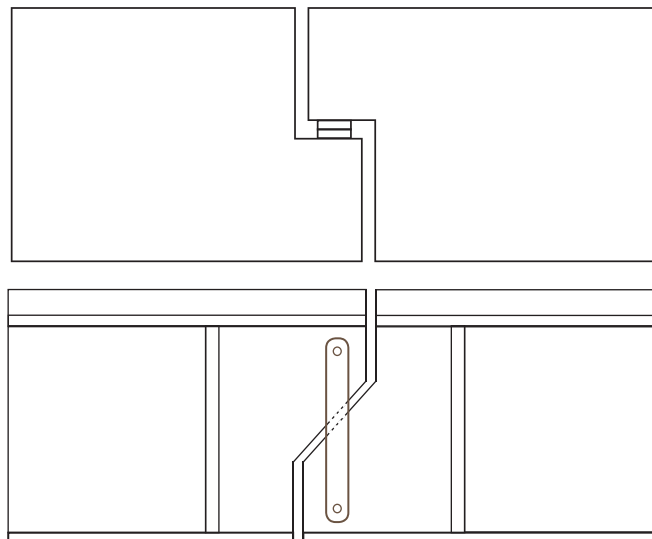

Figure 3.3: Failed Rocker Bearings (Yamhill River Bridge)



Another approach to accommodating temperature movements is through use of in-span hinges. In-span hinges can also be poor at resisting horizontal earthquake loads. Use of in-span hinges is less common in modern bridges.

Figure 3.4: In-Span Hinges



Damage to bearings or hinges can be catastrophic. The result can range from an impassable gap or bump in the roadway (vertical displacement of adjacent deck segments) to complete collapse of a span.

Strengthening bridges to prevent damage is called “retrofitting”. Retrofitting bridges against bearing and hinge failures can involve any of the following:

- Replace unstable bearings with stable bearings.
- Provide additional seat width.
- Limit movement of girders parallel to roadway using restrainers.
- Limit movement of girders perpendicular to roadway using shear lugs.

Figure 3.5: Restrainer at Pier

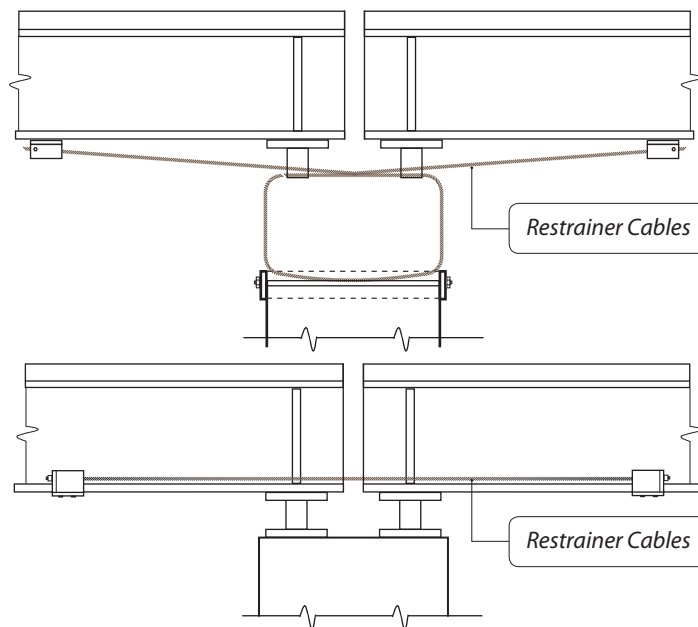

The cost of performing earthquake retrofit can be significant. The ODOT Bridge Program is funded at a level to maintain freight mobility and preserve major, high cost existing bridges, but not to retrofit existing bridges that are inadequate for seismic loading. Because of this, ODOT can only perform very limited earthquake retrofitting and must approach it in two stages. Phase I retrofitting includes only the items listed above. The essential goal of Phase I retrofitting is “life safety”. This is accomplished with retrofit details designed to prevent the superstructure from separating from the substructure and thereby preventing collapse of a span. This type of retrofit has proven to be highly

effective for moderate earthquakes. However, since substructure deficiencies are not addressed, bridge collapse in a large earthquake is possible.

Phase II retrofitting includes strengthening the substructure elements. This includes caps, columns, footings and piling. The primary goal of Phase II retrofitting is also “life safety”. Since Phase II retrofitting involves strengthening substructure elements, the result is a final structure that can provide “life safety” for the maximum anticipated earthquake. The cost of Phase II work is typically three times that of Phase I. To date, ODOT has performed very limited Phase II retrofit work.

Caltrans also used a similar phased approach for earthquake retrofitting. Based on California’s experience and limited funding in the Bridge Program, ODOT has chosen to perform Phase I retrofitting only when other rehabilitation is needed on a specific bridge. Our current approach provides a moderate level of protection for isolated retrofitted bridges at a cost that is consistent with the current Bridge Program funding level. Since complete retrofit carries a much higher cost, this type of phased approach maximizes the benefit gained from each retrofit dollar spent.

Figure 3.6 : Cost-to-Benefit Comparison for Seismic Retrofit

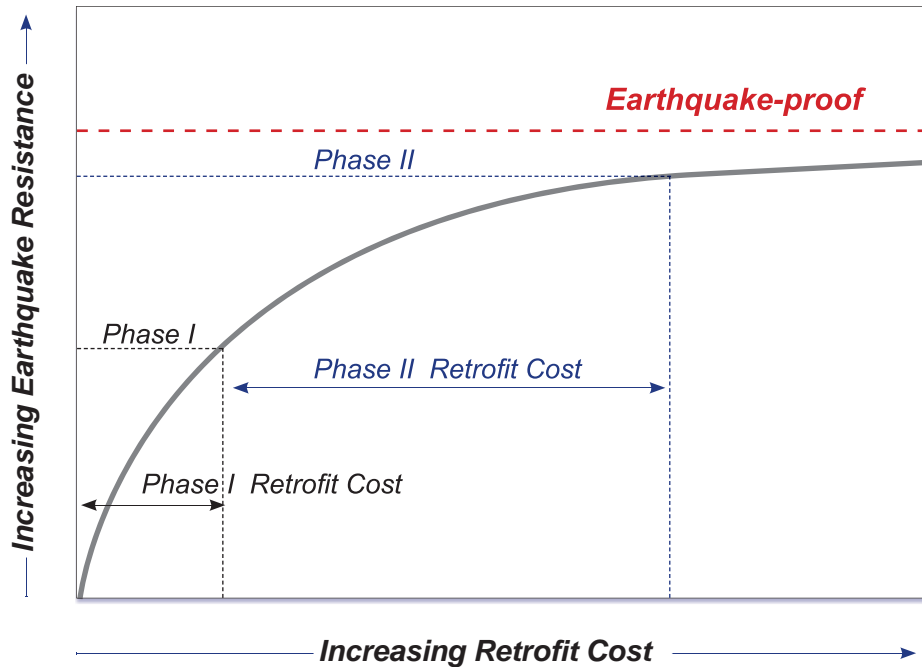

Horizontal movement from earthquakes can damage columns, footings and piling of older bridges that do not have adequate seismic details. Column damage of older bridges as shown in Figure 3.7 below can be minimized by using “ductile” details. Ductile details allow a column to sway back and forth several times without significant damage. Ductile detailing involves ensuring vertical column bars have adequate containment or lateral support. With adequate lateral support, columns can bend without breaking. This design concept has been implemented on all ODOT bridges designed within the last 25 years.

Figure 3.7 : Concrete Column Detailing

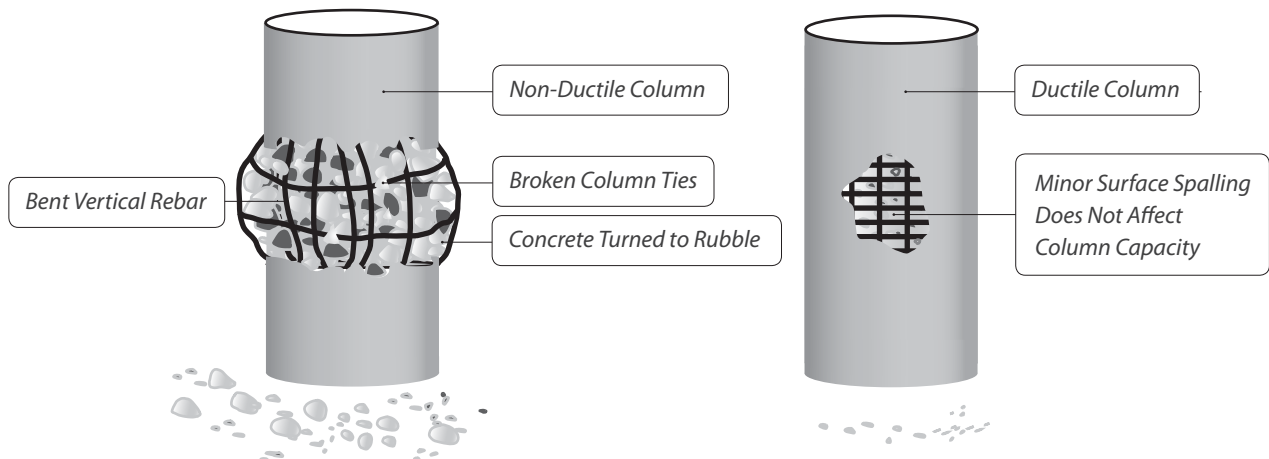

Modern bridges are designed using tighter spacing for lateral reinforcing steel. This tighter spacing provides the necessary lateral support to ensure ductile performance. Earthquake retrofit for older columns would involve wrapping a column with steel or composite fabric to increase the lateral support.

Since older bridges were designed for much lower earthquake forces, their foundations generally lack capacity to resist the expected horizontal loads. Retrofit of older foundations usually requires increasing the size of footings. Where foundations are supported by piling, more piles must be placed. Since there is often limited room to work under existing bridges, foundation retrofit is both difficult and very costly.

The design philosophy for earthquake retrofit is similar to that of a new bridge. Where reasonable, retrofits are designed such that the bridge will be serviceable for a moderate earthquake and provide collapse prevention (life-safety) in a large earthquake. However, it is not always possible to retrofit a bridge to the desired level without complete replacement. Even under the best circumstances, a new bridge designed and built according to today's standards would perform better than a retrofitted bridge.

The following sketch illustrates the various substructure retrofit concepts.

Figure 3.8 : Seismic Retrofit Concepts

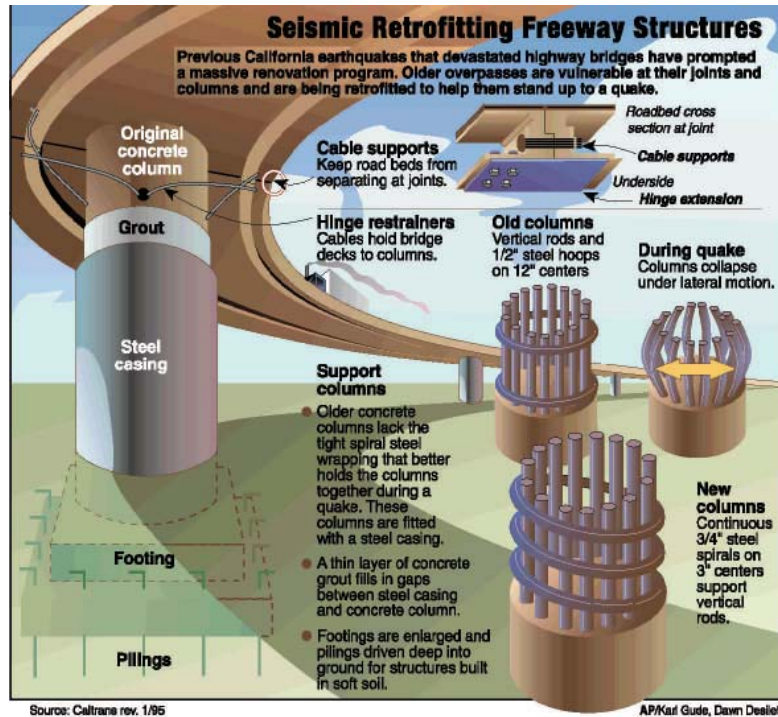

The concepts shown above are based on traditional Phase I and Phase II retrofitting concepts. "Base isolation" is another concept that can be considered in some unique circumstances. Base isolation involves placing ductile elements between the superstructure and substructure. This usually involves replacing existing bearings between the girders and caps with special base isolation bearings. This type of bearing allows some horizontal movements, but limits the amount of earthquake shaking that can be transmitted from the substructure to the superstructure. In this way, base isolation bearings "isolate" the superstructure from the earthquake to a certain extent. In the end, the earthquake forces that must be resisted by the substructure can be dramatically reduced. In some cases, it can eliminate the need for a Phase II retrofit. Base isolation generally costs more than a normal Phase I retrofit, but is substantially less than Phase II retrofit. This concept is not effective or practical on all structures, but is considered where it is practical. The main span of the I-5 Marquam Bridge in Portland and the west approach spans for the I-205 Abernethy Bridge in West Linn are examples where base isolation was used. In both cases, base isolation did not eliminate the need for a future Phase II retrofit, but provided improved earthquake protection over a Phase I retrofit.

PREVIOUS STUDIES

Highway Bridge Inventory

Over 2500 bridges make up the highway system owned by ODOT. Each bridge is unique, but the inventory can be generally classified by the bridge type as depicted in *Table 4.1*. Girder, beam and slab bridges are the dominate bridge types in the Nation Bridge Inventory (NBI).

Table 4.1: Types of State Owned NBI Bridges in Oregon

Bridge Type	Highway System Bridges	
	Single Span	Multi-Span
Stringer/Girder	222	1094
Slab	274	296
Multiple Box Beam	89	291
Frame / Girder-Floorbeam	31	43
Channel Beam	11	39
Truss-Thru	25	16
Arch-Deck	26	6
Truss-Deck	14	12
Single/Spread Box	12	15
Arch-Thru	9	5
Tunnel	9	0
Tee Beam	6	3
Movable-Bascule/Swing/Lift	9	4
Segmental Box Girder	0	1
Suspension	0	1
Other/Unclassified	4	0

The age of construction of bridges is also important when assessing seismic vulnerability because of the evolution of the seismology understanding of seismic risk as well as the engineering understanding of structural response and design to resist earthquake induced loads. *Figure 4.1* itemizes the year construction was completed and shows that 64% of bridges were constructed before the 1970s. In general, little consideration was given to seismic resistance prior to the San Fernando earthquake of 1971 (Roberts 1991), yet the majority of the inventory was built prior to that time. Furthermore, bridges completed before 1960 are now beyond or near the end of the originally intended 50-year design life.

Figure 4.1: Distribution of year of construction completion of Oregon's State Highways bridges

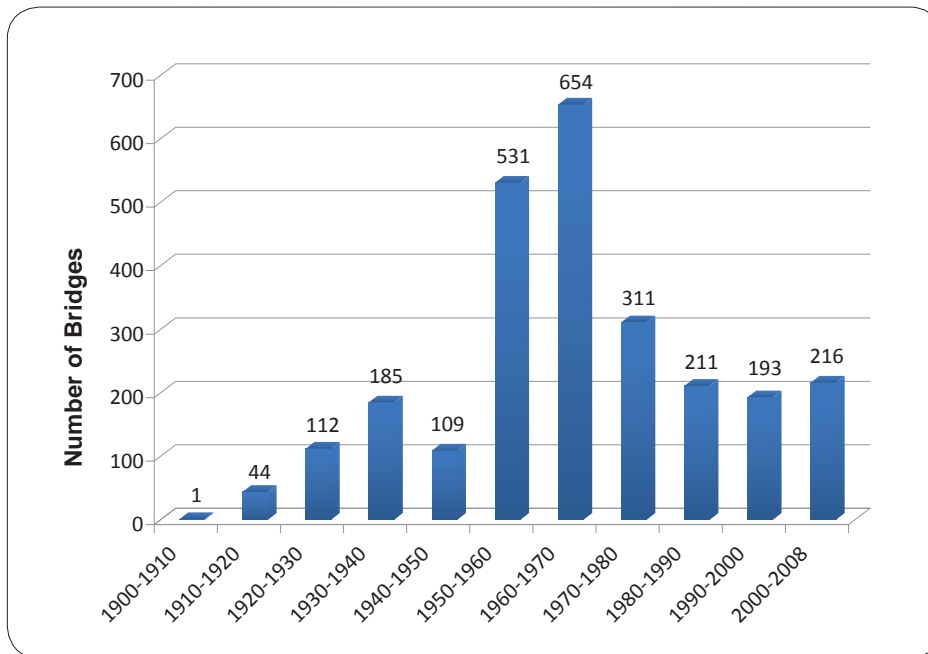

Early Seismic Vulnerability Studies

In February 1992, new evidence concerning Oregon's earthquake risk prompted ODOT to investigate methods to prioritize ODOT bridges for seismic retrofit. ODOT hired the consultant CH2M Hill for this task. The consultant investigated prioritization methods used by other agencies including Caltrans and WSDOT. They also looked at typical bridge details used in Oregon. Using this information CH2M Hill developed, a prioritization algorithm unique to Oregon bridges.

A final report was released in October of 1993 titled, "Prioritization of State Bridges for Seismic Retrofit". This report outlined a strategy and provided an algorithm to prioritize ODOT bridges for seismic retrofit. A ranking of bridges from most vulnerable to least vulnerable was provided. This report also provided the first estimate of retrofit cost. The report included only state-owned bridges.

After release of the initial CH2M Hill study, a second project was initiated to include local agency bridges. In November 1995, a report titled "Seismic Vulnerability of Local Agency Bridges" was released. This was an interim report that documented the vulnerability of only local agency bridges.

In January 1997, the report "Prioritization of Oregon Bridges for Seismic Retrofit" was released. This report was also prepared by CH2M Hill and included both state and local agency bridges. The report included a ranking of all Oregon bridges. A computer program was also provided so that ODOT and local agencies would be able to prepare rankings of their own bridges. It also allowed bridge information to be updated as they were retrofitted or replaced with newer bridges.

It should be noted that no liquefaction or soil information was included in the CH2M Hill reports. Although this information would have been very helpful, it was both cost and time prohibitive to include with the prioritization studies. Liquefaction issues were included later when potential projects were considered for funding. In most cases, bridges with significant liquefaction potential did not receive earthquake retrofit funding.

Concurrent with the final CH2M Hill report, ODOT produced a list of lifeline routes. The lifetime routes were used in conjunction with the vulnerability report to select and prioritize bridges for retrofitting. These lifeline routes were prepared with input from both ODOT and local agencies. The lifeline routes were prepared considering only earthquake impacts on the highway system with no identification of other critical infrastructure and supply lines, such as utilities, gasoline supply depots, or access to emergency supply depots.

Routes were generally selected based on their likelihood of being available following an earthquake. For this reason, routes with fewer vulnerable bridges were often selected as a lifeline route instead of higher volume parallel routes with many vulnerable bridges.

It was anticipated that the original lifeline routes would be updated as bridges were retrofitted and more secure routes became available. To date, however, no adjustments to the original lifeline routes have been made to account for replaced and retrofitted bridges. For this reason, the lifeline routes are no longer considered to be the most effective or reliable routes available. The lifeline routes were prepared only for the CH2M Hill prioritization and were never intended to be used for other emergency scenarios. Since future prioritization will include a corridor strategy, it is clear that there is a need to create updated earthquake lifeline routes for emergency response purposes.

Use and implementation of the CH2M Hill studies are discussed in **ODOT Seismic Mitigation Strategies** section, page 51.

The top ranked bridge from the 1993 prioritization was the I-5 Boone Bridge at Wilsonville. A Phase I retrofit project was then immediately initiated and completed in 1997.

Prior to the CH2M Hill studies, the I-5 Marquam Bridge in Portland was the first Oregon bridge to receive an earthquake retrofit. The Marquam Bridge is a double-deck structure that appears similar to the Cypress freeway that collapsed under the 1989 Loma Prieta earthquake in California. At the time, ODOT was completing plans to widen the east approach to this bridge and a decision was made to add earthquake retrofit to the project.

Cascadia Peril 2009 Exercise Model

Oregon Emergency Management conducted a week long exercise on April 24-30, 2009 to assess the State's emergency response to a 9.0 magnitude earthquake on the Cascadia Subduction Zone. ODOT participated by doing a desk exercise in the three western Regions. One specific task assigned to ODOT for this exercise was to provide organizers with the anticipated damage state of Oregon bridges after a similar earthquake. Because of the size, type and location of this earthquake, a large number of bridges would be affected. The narrow timeframe available to accomplish this task dictated the need for a quick and approximate approach to estimate the damage state after the simulated earthquake. The team assigned this task realized that there was not enough time to analyze each bridge's potential vulnerability individually. Under these circumstances, the team decided to establish a set of criteria to categorize the condition of all Oregon bridges subjected to ground motions from the simulated event. The effort to make this report as practical as possible led to the establishment of the three following damage states:

1. **Serviceable;** for bridges experiencing very little to no damage and being serviceable right after a post earthquake inspection.
2. **Damaged;** for bridges experiencing moderate to little damage, and requiring extensive repair work before re-opened to service.
3. **Collapsed;** for bridges totally collapsed or with individual spans collapsed during this earthquake. A full or partial replacement of these bridges was anticipated.

The following criteria was utilized for determining the damage state of each bridge after the earthquake:

- a. The report titled "Prioritization of Oregon Bridges for Seismic Retrofit", provided by CH2M HILL in January 1997, was used as a preliminary screening of Oregon bridge deficiencies. The report identified all major bridge deficiencies and placed them into Vulnerability Groups as described in *Table 4.2*. These Vulnerability Groups were then used in combination with estimates of PGA and other criteria to assess their potential damage state.

Table 4.2 : Seismic Prioritization Model Vulnerability Groups

Group No.	Description
1A	Unstable bearings
1B	Stable bearing with inadequate anchorage or seat capacity
1C	Single span with inadequate seat capacity
1D	In-span hinges with no other superstructure deficiencies
2A	Single column piers
2B	Three substructure deficiencies
2C	One or two substructure deficiencies
3	Bridges with no vulnerabilities. Timber superstructure bridges. Single-span with adequate anchorage or seat capacity
4	Missing Plans
R	Fully retrofitted (Phases I and II)
D	Designed for seismic loads
S	Special analysis required

- b. All bridges experiencing a PGA of 0.15g or less will sustain no damage under this earthquake.
- c. All single span bridges will experience no damage under this earthquake, given that the majority of them with previously identified seismic deficiencies have been retrofitted already.
- d. Bridges falling under Vulnerability Groups 1A, 1D, 2A, 2B, 2C and S will be either “Damaged” if experiencing a PGA of 0.15g to 0.25g, or “Collapsed” if experiencing a PGA of 0.25g or higher.
- e. Bridges falling under Vulnerability Group 3 and built before 1940 will be either “Damaged” for PGA between 0.15g and 0.25g, or will be “Collapsed” for PGA of 0.25g or higher.

After establishing the criteria for evaluating the damage state of ODOT bridges after this earthquake, the Peak Ground Acceleration Map for this specific earthquake was established based on the attenuation relationships from Youngs, et. al. (1997) ^[4] (Figure 4.2). Because of the initial assumptions for bridges experiencing a PGA of 0.15g or less, the map of PGA for the M 9.0 Cascadia Subduction Zone Earthquake was drawn only for the western part of the state where such conditions occur.

A total of 2,671 bridges were identified to experience a PGA of 0.15g or higher, 593 of which were single span bridges. The results of this exercise showed that 399 bridges would have totally or partially collapsed under a M 9.0 Cascadia Subduction Zone earthquake, and 621 bridges would have been heavily damaged. The rest of them (1,651 bridges) were identified to be serviceable after the strong shaking of this infrequent earthquake.

Based on this quick and approximate assessment, it was evident that the effects of this earthquake was widespread across the most dynamic portion of the transportation network. In addition to the heavy damaged along the Oregon Coast Highway (US101), many portions of I-5 and US99 would not be traversable as well. Also, most state routes connecting Interstate I-5 with the Oregon Coast Highway would be closed. The estimated time of closure could be 3 to 12 months, assuming emergency contracting provisions and the use of temporary bridges would be used to restore traffic. This would be a temporary solution and it would be associated with limitations on load capacity for the majority of bridges. The restoration of the entire transportation network could take 3 to 5 years, and would require a nationwide effort because of the limited workforce and resources availability within Oregon.

HIGHWAY MOBILITY IMPACTS FROM SIMULATED SEISMIC EVENTS

Earthquake damage to components along important and non-redundant links within the system will have a greater impact on the system performance than will other components. Hence, components should not be treated as individual entities only but on how the extent of its damage impacts the highway system performance. Therefore, consideration should be given to both systemic and combined effects to have a more rational basis for establishing seismic retrofit priorities and performance requirements for bridges and other highway components.

Bridge Seismic Vulnerability Assessment of the Network

The Seismic Risk Analysis (SRA) methodology is a synthesis of models developed by earth scientists, geotechnical and structural earthquake engineers, transportation engineers and planners, and economists. The methodology can develop multiple types/forms of results from deterministic or probabilistic approaches and from local to large geographic areas. Such results can be developed for use in pre-earthquake assessment of various options for seismic risk reduction after an actual earthquake.

To carry out SRA of bridges, tools such as: HAZUS, software developed by the Federal Emergency Management Agency (FEMA), and REDARS 2, software for SRA developed by the Federal Highway Administration, can be used. These tools typically utilize publicly available databases to define roadway topology and attributes, bridge locations and attributes, origin-destination (O-D) zones and pre-earthquake trip tables and site-specific NEHRP soil conditions. Of these, only REDARS 2 has an integrated ability to analyze the transportation network as a system, considering both direct losses due to damage and indirect losses due to traffic flow disruption.

The methodology to carry out deterministic or probabilistic seismic risk analysis is depicted in *Figure 5.1*. For probabilistic SRA, results are developed for multiple simulations, in which a “simulation” is defined as a complete set of system SRA results for one particular set of randomly selected input parameters and model parameters. The model and input parameters for one simulation may differ from those for other simulations because of random and systematic uncertainties.

For deterministic SRA, one set of results is developed either for median input and model parameters or for one set of randomly selected parameters. This multi-disciplinary procedure uses geoseismic, geotechnical and structural engineering, repair/construction, transportation network, and economic models to estimate hazards, component performance, system performance and losses such as economic impacts due to repair costs and losses due to travel time delays.

Earthquake Scenarios

In a SRA of any lifeline system, scenarios are needed to evaluate systemic consequences of damage of individual earthquakes on components at diverse locations. Scenario earthquakes are developed as part of the initialization phase of the SRA methodology. In this, regional earthquake models are used to develop a table of earthquake occurrences over time, in which each earthquake is represented as magnitude and location and the occurrences over time characterize the frequencies of occurrence for earthquakes of various magnitudes and locations. This tabular listing of earthquake occurrences is used in the implementation of probabilistic SRA as a walkthrough analysis (Daykin et al., 1994). This approach facilitates development of loss distributions from the SRA, estimation of confidence levels and limits of these loss results, and display of their variability over time.

The SRA methodology incorporates regional earthquake source models that have been adapted from models used by the United States Geological Survey (USGS) during their development of seismic hazard maps for the conterminous United States (Frankel et al., 2002). The USGS models have been selected because of their development by recognized earth scientists and because of their subsequent extensive external review process.

The ground shaking sources that can be used to conduct these analyses are shakemaps, walkthrough tables and a point source earthquake.

- **Shakemap.** A ShakeMap is a representation of ground shaking produced by an earthquake. It is a product of the USGS Earthquake Hazards Program in conjunction with regional seismic network operators.
- **Walkthrough.** From the Walkthrough Earthquake Selection form and in turn pick a walkthrough earthquake by walkthrough year number.
- **Mag. @ X/Y.** This is the point-source earthquake selection that consists of a magnitude (in g's) and a location expressed as longitude and latitude.

Figure 5.1 : Seismic Risk Analysis of Roadway Systems

(Technical Manual: REDARS 2 Methodology And Software For Seismic Risk Analysis Of Highway Systems)

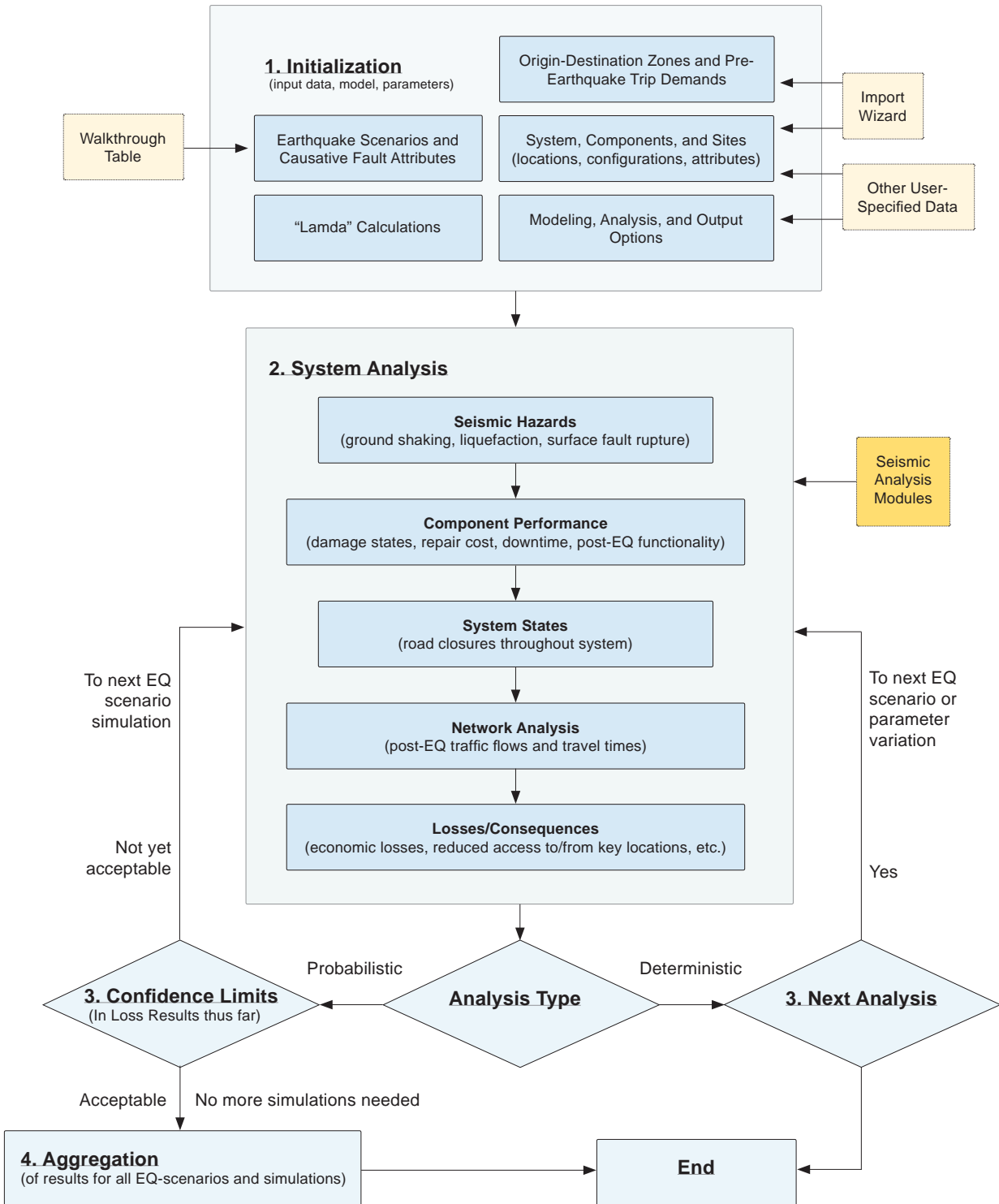

Bridge Damage States

With modern methodologies, the bridge damage resulting from an earthquake event can be classified into damage states ranging from no damage to complete collapse. The bridge model utilized for SRA of the Oregon transportation network was based on HAZUS99-SR2, which defines bridge capacities in terms of spectral accelerations leading to the onset of five damage states listed in *Table 5.1* for each of several “standard bridge” classifications.

Table 5.1 : Damage States considered in HAZUS99-SR2 Bridge Model

Damage State Designation		Description of Typical Expected Damage
Number	Level	
1.	None	Up to first yield.
2.	Slight	Minor cracking and spalling of the abutment, cracks in shear keys at abutment, minor spalling and cracking at hinges, minor spalling of column requiring no more than cosmetic repair, or minor cracking of deck.
3.	Moderate	Any column experiencing moderate shear cracking and spalling (with columns still structurally sound), moderate movement of abutment (< 5.1 cm) (< 2 inches), extensive cracking and spalling of shear keys, connection with cracked shear keys or bent bolts, keeper bar failure without unseating, rocker bearing failure, or moderate settlement of approach.
4.	Extensive	Any column degrading without collapse (e.g., shear failure) but with column structurally unsafe, significant residual movement of connections, major settlement of approach fills, vertical offset or shear key failure at abutments, or differential settlement.
5.	Complete	Collapse of any column or unseating of deck spans leading to collapse of deck. Tilting of substructure due to foundation failure.

Once the capacity for a given bridge is estimated, a ground motion model is used to estimate the bridge's site-specific demand ground motions (in terms of spectral accelerations $Sa(1.0)$ and $Sa(0.3)$) for each scenario earthquake. The capacity for the bridges is computed including effects of uncertainties. However, the capacity modification factors are developed by statistical analysis for each damage state and are the mean values.

Estimation of ground motions for different scenario earthquakes and simulations includes effects of uncertainties in earthquake magnitude and location, ground motion attenuation characteristics, and soil amplification effects. For example, the Abrahamson-Silva (1997) ground motion model estimates spectral accelerations caused by shallow crustal earthquakes in active tectonic regions of the Western United States, excluding subduction earthquakes. The Abrahamson-Silva ground motion model expresses the natural logarithm of the ground motion as a function of earthquake magnitude, source-site distance, local soil conditions, type of faulting, whether the site is along the hanging wall or footwall of the ruptured fault plane, and inter-event and intra-event uncertainties. This functionality is represented through a series of numerical coefficients that are used to compute each term in this equation.

Once the bridge's demand is computed for a given scenario earthquake, it is compared to each bridge's capacity that leads to the onset of each damage state in order to estimate the bridge's damage state for the particular earthquake and simulation.

Incorporation of the Transportation Network

To create the Oregon network model, 5 format-specific databases were obtained and modified to the appropriate format. The 6 categories of data required and collected, analyzed and modified to the suitable format were:

1. National Highway Planning Network Database (NHPN)
2. Highway Performance Monitoring System Database (HPMS)
3. National Bridge Inventory Database (NBI)
4. Supplemental Geotechnical Data (collected by the user)
5. Traffic Analysis Zone Map of the region (TAZ map)
6. Origin-Destination Trip Data (O-D Matrices)

These datasets were used to define the transportation network and the associated traffic flow. The bridges become vulnerable links within the network and when damaged change the traffic demand placed onto the system.

Estimate of Economic Impact

One of the most important end results from SRA of roadway systems is the estimation of economic impacts of earthquake damage to the system. Bridge damage results not only in high cost of structural repair but also safety concerns by severely disrupting traffic flow which in turn will impact post-earthquake emergency response, repair and reconstruction operations and long term economic consequences due to the valued loss of time when commuter and freight travel slows down due to the disrupted network. From this, it is apparent that earthquake damage to certain components (e.g., those along important and non-redundant links within the system) will have a greater impact on the system performance than will other components. Current criteria for prioritizing bridges for seismic retrofit is done by using average daily traffic count, detour length, and route type as parameters. Earthquakes, in addition to damaging the roadway system, can also damage buildings, contents, and lifeline infrastructure which were not considered to be part of this highway bridge vulnerability study.

The SRA methodology uses the bridge and network data to estimate direct and indirect economic losses due to disruption in the system. The SRA considers repair costs, losses due to earthquake-induced travel-time delays and losses from trips foregone due to earthquake-induced increases in traffic congestion. The replacement costs are calculated as a product of a base cost of \$165/ft², the deck area and a factor of 3.2 (to incorporate associated costs such as approaches, traffic control, etc.) with a \$3 million minimum cost. And when estimating the cost of a new bridge with an old bridge, a further multiplication factor of 1.2 is used, because the new bridge is expected to be of a larger dimension than the old one. The repair cost is computed as the product of a repair cost which depends on the bridge's damage state, and replacement cost.

Equation 1

Replacement Cost = max of

- \$165/ft² x the deck area x 3.2 x 1.2 (when using a "old" bridge to estimate the cost of replacement of a "new" bridge)
- \$3 million

Equation 2

Retrofit Cost (Phase I) = \$35/ft² x the deck area

Retrofit Cost (Phase II) = \$90/ft² x the deck area

Using the above cost estimates, the inventory replacement value of over 2500 bridges that are part of the Oregon State Highway system is about \$23,700 million. Phase I retrofit cost is a little over \$1,200 million and phase II retrofit cost is about \$3,000 million. *Table 5.2* gives a breakdown of the distribution and replacement and retrofit cost of the bridges along the major highway routes.

Table 5.2 : Replacement value of State Highway Bridges along selected routes.

Route	Number of Bridges	Replacement Cost (in million \$)	Retrofit Cost Phase I	Retrofit Cost Phase II
I-5 (Multnomah to Clackamas)	95	\$2,262	\$125	\$321
I-5 (Clackamas to Lane)	215	\$1,611	\$84	\$215
I-5 (Lane to Jackson)	166	\$1,486	\$82	\$211
I-84	290	\$2,630	\$142	\$366
US-101	143	\$1,943	\$103	\$264
US-26	133	\$952	\$46	\$117
I-205	76	\$2,083	\$114	\$294
I-405	50	\$1,179	\$53	\$137
US-30	38	\$431	\$23	\$59
US-20	80	\$399	\$19	\$49
OR-38	16	\$90	\$5	\$12
OR-42	54	\$432	\$24	\$61
Others	1213	\$8,206	\$417	\$1,073
Total	2567	\$23,704	\$1,236	\$3,178

Table 5.3 shows the percentage of replacement cost used to calculate repair costs for the different damage states after an event. Following existing ODOT practice, if the repair cost of a bridge is more than 50% the replacement cost, the bridge is typically replaced rather than repaired. Hence, a bridge that is in the “extensive” damage state will have the same minimum cost as complete collapse.

Table 5.3 : Average Repair Cost Estimate

Damage State	% of replacement cost	Min Cost
None	0	0
Slight	3	\$100,000
Moderate	25	\$500,000
Extensive	100	Min \$3 Million
Collapse	100	Min \$3 Million

The cost of earthquake induced traffic disruption is calculated using zone-to-zone trip demands and the corresponding changes in travel time estimated by a variable demand model. This cost includes the value of time due to increased traveler time on the roadway and the value of trips foregone.

Table 5.4 gives average daily traffic on major state highways in the State of Oregon. These values are the maximum average daily traffic values.

Table 5.4 : Average Daily Traffic on State Highway Bridges along selected routes.

Route	Average Daily traffic
I-5 (Multnomah to Clackamas)	155,800
I-5 (Clackamas to Lane)	94,900
I-5 (Lane to Jackson)	50,200
I-84	171,400
US-101	27,000
US-26	152,000
I-205	176,225
I-405	113,400
US-30	48,695
US-20	22,700
OR-38	4,700
OR-42	24,800

Oregon Seismic Network Model

Study Area

The focus of the seismic vulnerability assessment has been on bridges lying on or crossing over Oregon highway routes in the area defined by *Figure 5.2*. The area includes all highway routes lying inside or west of the I-5 corridor, highway routes in the Portland area, the entire length of US-101 and a part of I-84 Columbia River Highway. The bridge data was collected to include bridges up to the year 2008.

Figure 5.2 : Study Area Focus

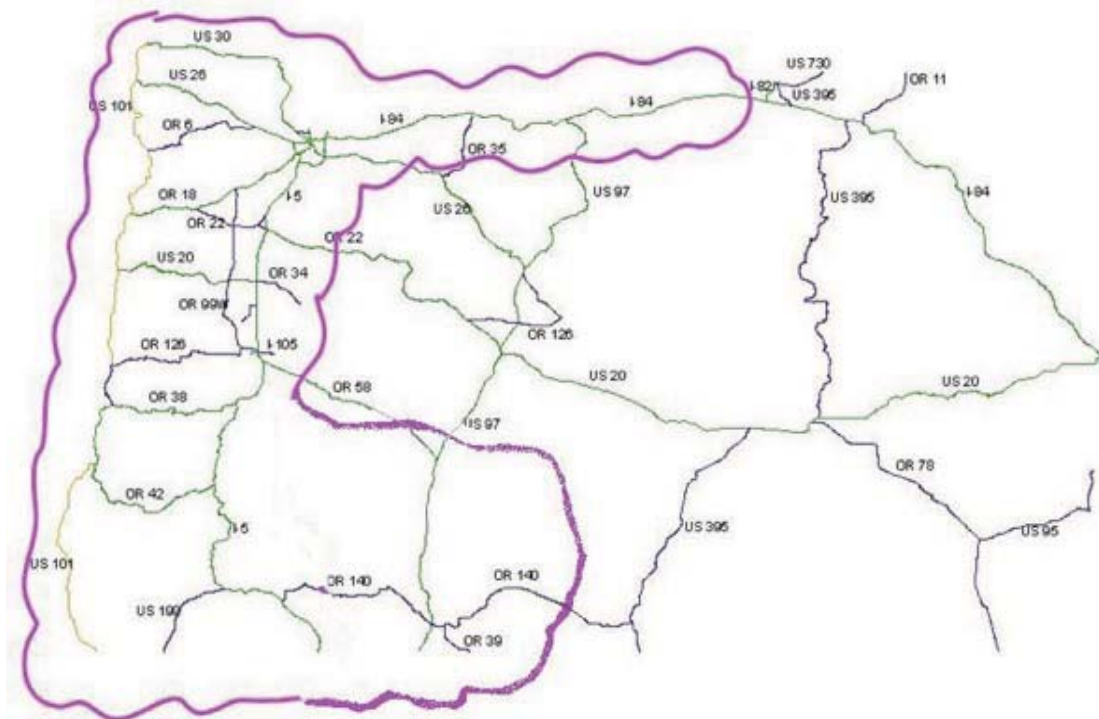

In total, the study area includes over 1,900 bridges. Over 1,500 of these bridges lie on major routes. *Table 5.5* gives a breakdown of the distribution of the bridges on major routes. Notably, 499 bridges, or 36% of the bridges considered, lie on Interstate 5, generally considered one of Oregon's important routes. *Figure 5.3* breaks down the predominant types of material of bridges considered in the assessment.

Table 5.5: Distribution of bridges on major routes

Route	Number of Bridges
I-5	499
I-84	160
US-101	142
US-26	54
I-205	74
I-405	47
US-30	23
US-20	31
OR-38	18
OR-42	54

Figure 5.3: Distribution of predominant types of material

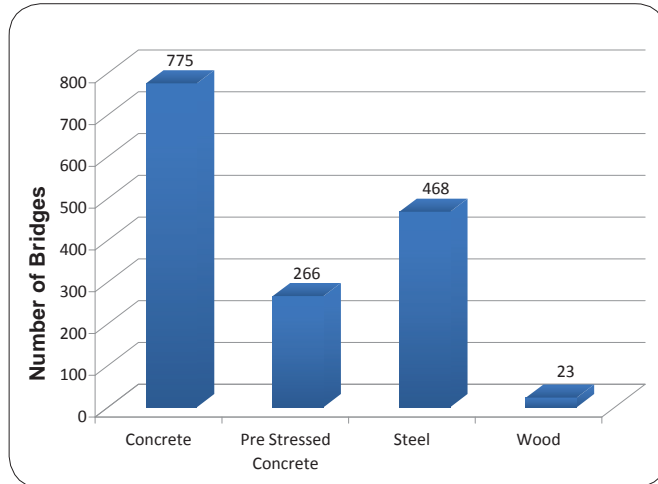

Table 5.6 evaluates the predominant types of design of the majority of bridges considered in the assessment. 825 (54%) of the bridges considered are of stringer/multibeam design; 267 (18%) are multiple box beams or girders, and 216 (14%) are slab bridges.

Table 5.6: Distribution of predominant design types in the REDARS 2 Study

Bridge Type	Highway System Bridges	
	Single Span	Multi-Span
Stringer/Girder	157	668
Slab	76	140
Multiple Box Beam	61	212
Frame / Girder-Floorbeam	2	30
Channel Beam	0	7
Truss-Thru	2	10
Truss-Deck	8	20
Arch-Deck	1	14
Single/Spread Box	9	15
Arch-Thru	5	2
Tunnel	0	1
Tee Beam	0	2
Movable-Bascule/Swing/Lift	3	3
Suspension	0	1

Figure 5.4 itemizes the year construction was completed of each of the considered bridges in the model. The figure shows that while 531 (35%) of the bridges were constructed after 1970, the rest were constructed before 1970.

Figure 5.4 : Distribution of year of construction completion in the REDARS 2 Study

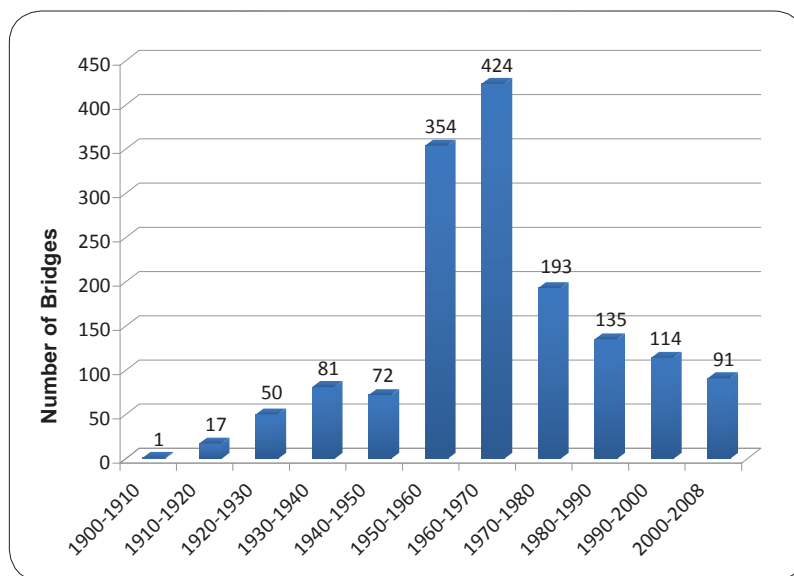

State Earthquake Scenarios Used in Analysis

The earthquake scenarios considered for this study are subduction zone earthquakes and crustal earthquakes.

Subduction Zone Earthquakes: Though no earthquakes have been recorded on the Cascadia Subduction Zone during Oregon’s short 150-year historical record, numerous studies have found widespread evidence that very large earthquakes have occurred, most recently about 300 years ago, in January 1700 (e.g., Atwater, 1987; Yamaguchi and others, 1997). The best available evidence and observations indicate that these earthquakes occur on average about every 500 years. Hence, it is important to make an analysis of a scenario CSZ earthquake so as to make a reasonable prediction of the effects of the assumed earthquake. This knowledge of potential damage will allow for planning and preparedness purposes.

Crustal Earthquakes: Crustal earthquakes occur in the North American plate at relatively shallow depths of 10–20 km (6–12 mi) below the surface. The 1993 magnitude 5.6 earthquake at Scotts Mills, Oregon (Madin and others, 1993) and the 1993 magnitude 5.9 and 6.0 Klamath Falls, Oregon, main shocks (Wiley and others, 1993) are examples of crustal earthquakes that have occurred in Oregon. Consequently, crustal earthquake scenarios are also examined for the Oregon model.

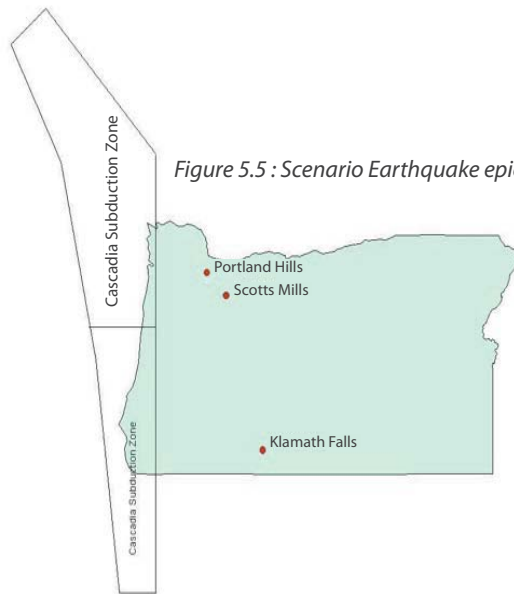

Figure 5.5 : Scenario Earthquake epicenter locations

Figure 5.5 shows the locations of scenario earthquakes for both crustal and subduction zone events, that have been included as part of the state wide analyses of the transportation network. The locations are selected based on history of seismic activity, distance from potentially active faults and proximity to critical highway routes.

Crustal Earthquake Scenarios in the Portland Metro Area

For an earthquake scenario of magnitude 7.0 in the Portland Metro Area, there were 5 complete collapses, 48 extensive, 41 moderate and 27 slight bridge damage states. The losses calculated were \$1,577 million for bridge repair and replacement and \$68 million travel time related losses. Figure 5.6 (a) shows a map of the component damage states in the Portland Metro Area.

Figure 5.6 (a) : Component Damage States for a Magnitude 7.0 Scenario EQ around Portland Hills

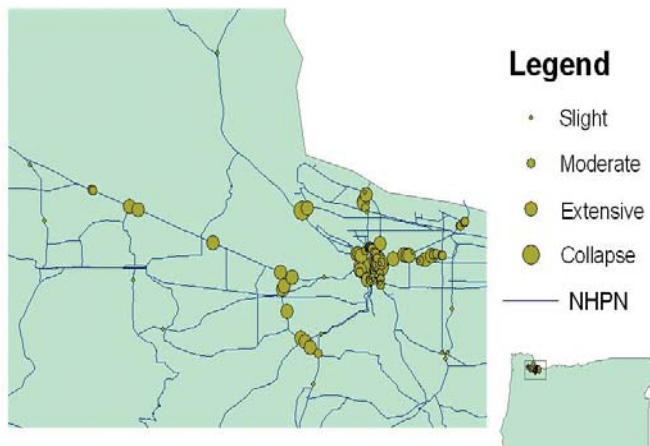

Crustal Earthquake Scenarios in the Scotts Mills Area

For an earthquake scenario of magnitude 7.0 at Scotts Mills, there was one complete collapse, two extensive, two moderate and three slight damage states. The losses calculated were \$14 million for bridge repair and replacement and \$29 million in travel time related losses. *Figure 5.6 (b)*

Figure 5.6 (b) Component Damage States for a Magnitude 7 Scenario EQ around Scotts Mills

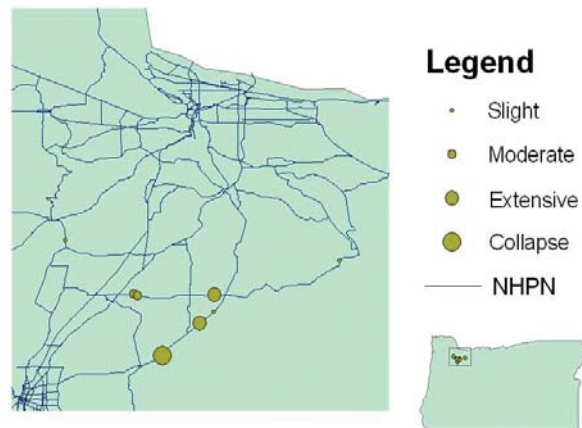

Crustal Earthquake Scenarios in the Klamath Falls Area

A magnitude 6.5 scenario earthquake around Klamath Falls resulted in no complete collapses, 7 extensive, 6 moderate and 3 slight damage states. The losses were \$109 million for bridge repair and replacement and \$3 million in travel time related losses. *Figure 5.7*

Figure 5.7 : Component Damage States for Magnitude 6.5 Scenario EQ around Klamath Falls



Cascadia Subduction Zone Earthquake near Southern Oregon

An earthquake scenario of magnitude 8.3 at the Cascadia Subduction Zone near Southern Oregon produced 2 complete collapses, 23 extensive, 33 moderate and 123 slight damage states. The losses evaluated were \$363 million for bridge repair and replacement and \$94 million travel time related losses. *Figure 5.8* shows a map of component damage states for the southwestern part of Oregon.

Figure 5.8: Component Damage States for a Magnitude 8.3 Cascadia Subduction Zone Scenario EQ near southern Oregon

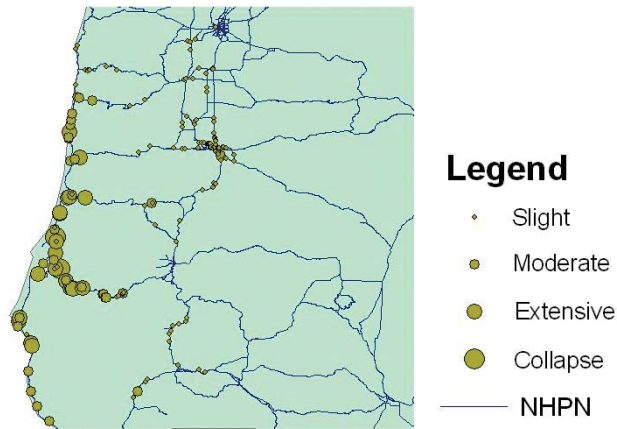

Cascadia Subduction Zone Earthquake near Northern Oregon

An earthquake scenario of magnitude 8.3 at the Cascadia Subduction Zone near northern Oregon produced no complete collapses, 28 extensive, 32 moderate and 152 slight damage states. The losses evaluated were \$336 million for bridge repair and replacement and \$8 million travel time related losses. *Figure 5.9* shows a map of component damage states for the northwestern part of Oregon.

Figure 5.9: Component Damage States for a Magnitude 8.3 Cascadia Subduction Zone Scenario EQ near northern Oregon

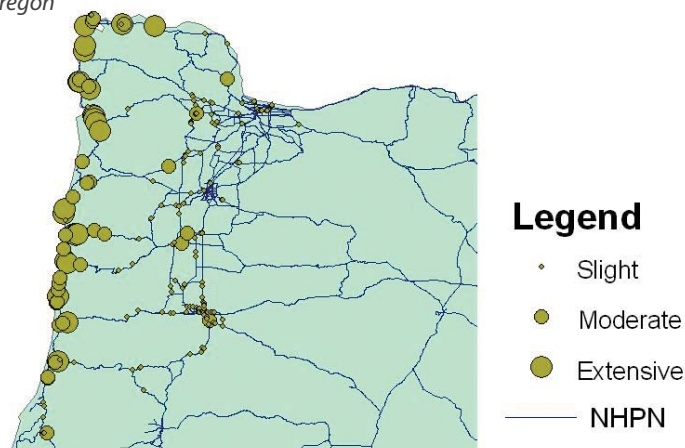

Full Length Cascadia Subduction Zone Earthquake

The Abrahamson-Silva ground motion attenuation model only estimates spectral accelerations caused by shallow crustal earthquakes in active tectonic regions of the western United States and excludes the Subduction Earthquakes. Therefore, for the CSZ earthquake events, a Cascadia Subduction Zone earthquake scenario ShakeMap is used as a ground shaking source.

Figure 5.10: Scenario ShakeMaps – (a) CSZ magnitude 9.0; (b) CSZ magnitude 8.3 North; (c) CSZ magnitude 8.3 South

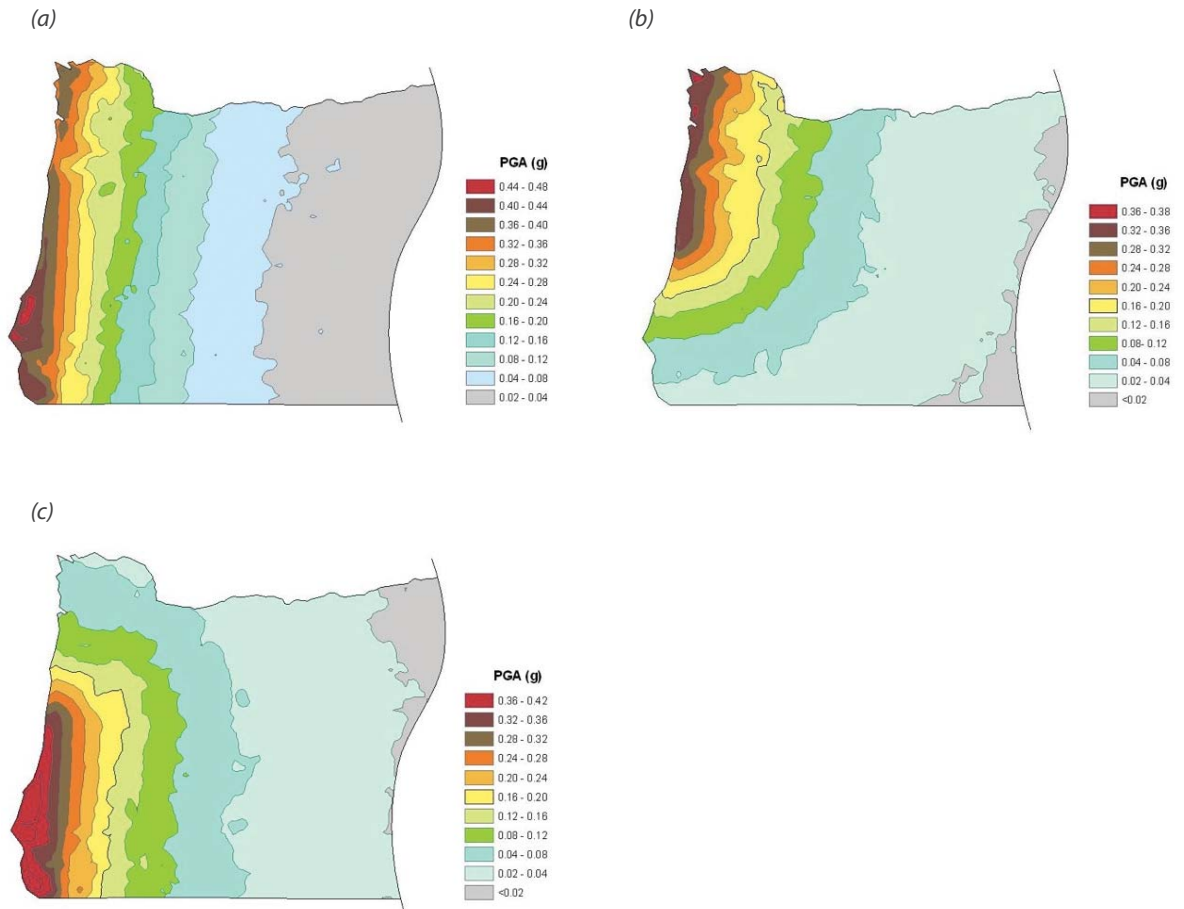

An earthquake scenario of magnitude 9.0 at the Cascadia Subduction Zone resulted in 6 complete collapses, 64 extensive, 106 moderate and 164 slight damage states. The losses calculated were \$1,080 million for bridge repair and replacement and \$177 million travel time related losses. *Figure 5.11* shows a map of component damage states for the western part of Oregon.

Figure 5.11 : Component Damage States for a Magnitude 9.0 Cascadia Subduction Zone Scenario EQ

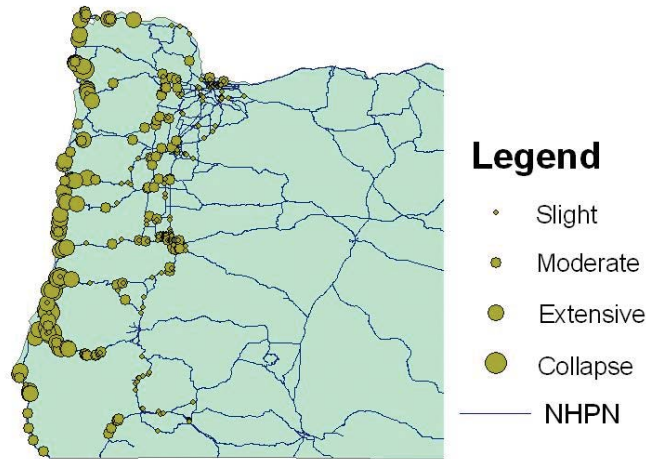

Table 5.7 : Summary of Seismic Hazard Analysis

Event	Route	Damage States				Economic loss (in Million \$)		
		Slight	Moderate	Extensive	Complete	Bridge Repair/Replacement	Travel Time Loss	
CZ 9.0	I-5 (Mult-Clack)	5	1	0	0	\$8		
	I-5 (Clack-Lane)	18	3	1	0	\$14		
	I-5 (Lane-Jacks)	22	0	0	0	\$5		
	I-84	10	0	0	0	\$3		
	US-101	7	14	35	5	\$684		
	US-26	7	4	0	0	\$8		
	I-205	8	2	0	0	\$10		
	I-405	7	0	0	0	\$2		
	US-30	5	3	2	0	\$26		
	US-20	4	3	5	0	\$19		
	OR-38	3	2	1	0	\$9		
	OR-42	4	13	13	1	\$147		
	Others	64	61	7	0	\$145		
	Total		164	106	64	6	\$1,080	\$177

Event	Route	Damage States				Economic loss (in Million \$)	
		Slight	Moderate	Extensive	Complete	Bridge Repair/Replacement	Travel Time Loss
CSZ 8.3 North	I-5 (Mult-Clack)	1	0	0	0	\$0.4	
	I-5 (Clack-Lane)	18	1	0	0	\$5.3	
	I-5 (Lane-Jacks)	0	0	0	0	0	
	I-84	7	0	0	0	\$2	
	US-101	7	18	19	0	\$252	
	US-26	7	0	0	0	\$1	
	I-205	4	0	0	0	\$1	
	I-405	0	0	0	0	0	
	US-30	4	2	2	0	\$18	
	US-20	2	2	4	0	\$13	
	OR-38	4	0	0	0	\$1	
	OR-42	4	1	0	0	\$5	
	Others	94	8	3	0	\$37	
	Total	152	32	28	0	\$336	\$8
CSZ 8.3 South	I-5 (Mult-Clack)	0	0	0	0	0	
	I-5 (Clack-Lane)	19	1	0	0	\$5	
	I-5 (Lane-Jacks)	16	0	0	0	\$4	
	I-84	0	0	0	0	0	
	US-101	7	16	11	1	\$208	
	US-26	0	0	0	0	0	
	I-205	0	0	0	0	0	
	I-405	0	0	0	0	0	
	US-30	0	0	0	0	0	
	US-20	8	0	0	0	\$1	
	OR-38	4	0	0	0	\$1	
	OR-42	9	10	10	0	\$118	
	Others	62	5	1	0	\$22	
	Total	123	33	23	2	364	\$94

Event	Route	Damage States				Economic loss (in Million \$)	
		Slight	Moderate	Extensive	Complete	Bridge Repair/Replacement	Travel Time Loss
Portland Hills 6.5	I-5 (Mult- Clack)	8	11	10	1	\$483	
	I-5 (Clack-Lane)	0	0	0	0	0	
	I-5 (Lane- Jacks)	0	0	0	0	0	
	I-84	2	4	11	1	\$170	
	US-101	0	0	0	0	0	
	US-26	4	3	7	0	\$64	
	I-205	5	4	0	0	\$14	
	I-405	2	11	4	2	\$322	
	US-30	1	0	1	1	\$122	
	US-20	0	0	0	0	0	
	OR-38	0	0	0	0	0	
	OR-42	0	0	0	0	0	
	Others	5	8	15	0	\$402	
	Total	27	41	48	5	\$1,577	\$68
Scott Mills 7.0	I-5	0	0	0	0	0	
	I-84	0	0	0	0	0	
	US-101	0	0	0	0	0	
	US-26	0	0	0	0	0	
	I-205	0	0	0	0	0	
	I-405	0	0	0	0	0	
	Others	3	2	2	1	\$14	
Total	3	2	2	1	\$14	\$29	
Klamath Falls 7.0	I-5	0	0	0	0	0	
	I-84	0	0	0	0	0	
	US-101	0	0	0	0	0	
	US-26	0	0	0	0	0	
	I-205	0	0	0	0	0	
	I-405	0	0	0	0	0	
	Others	3	6	7	0	\$109	
Total	3	6	7	0	\$109	\$3	

ODOT SEISMIC MITIGATION STRATEGIES

Current retrofit strategy and summary of progress

Approximately 2,550 State-owned bridges were screened for seismic deficiencies as part of the 1993 CH2M HILL Seismic Prioritization Report, and a total of 1,670 bridges were found to have insufficient capacity to resist earthquake loadings. Using a Unit Retrofit Cost of \$13.00/ft² for Phase I seismic retrofit and \$32.00/ft² for Phase II seismic retrofit, CH2M HILL estimated a total of \$223.18 million was needed to retrofit all bridges needing a Phase I seismic retrofit plus \$1,006.95 million for bridges needing a Phase II seismic retrofit. The above figures, estimated in 1997 dollars, did not include Engineering and Contingencies costs, which vary from 30% to 40% of the construction cost.

Even though ODOT had developed this very detailed information the Bridge Section has not established a comprehensive Seismic Retrofit Program due to the lack of funding resulting in part from bridge programming efforts being focused on resolving structural deficiencies that impede freight mobility. Under these circumstances, ODOT developed a cost effective strategy to select bridges that would undergo seismic retrofit. Using a small portion of the Bridge Program allocation, ODOT focused on improving longer segments of highways with the available funding. In other words, ODOT did not necessarily retrofit the most vulnerable bridges in the state; instead, bridges which would offer the highest mile/dollar improvement (after being retrofitted) were selected. Additionally, bridges at the end of their life cycle were replaced rather than retrofitted.

Limited funding allowed ODOT to accomplish only part of the initial goal of seismically retrofitting state bridges. As of 2009, 178 bridges have received a Phase I seismic retrofit. The most typical retrofit strategy employed was to improve the superstructure to substructure connection. This was commonly achieved by "tying down" the bridge girders to the respective piers by using restraint cables. These cables will accommodate the temperature movements of the structure, but also restrain the superstructure from falling off the bent caps when subjected to earthquake induced motions.

Figure 6.1 : Seismic Retrofit of Marquam Bridge Using Restrain Cables.



Figure 6.2 : Abernathy Bridge – Bearing Retrofit



In some cases, the approach involved the replacement of unstable bearings with new bearings that would perform better under cyclic horizontal earthquake loading. The most common type of bearing used for this phase of retrofit are reinforced elastomeric bearings. Installing seismic restrainer cables and replacing unstable bearings was found to be a practical and relatively inexpensive solution for providing the most basic retrofit for the majority of bridges. However, it is not the “bread and butter” solution for all vulnerable bridges. In some instances, seismic restrainers by themselves would not be able to accommodate the range of movement and could not sustain the horizontal forces induced by earthquakes for long and heavy bridge spans. Installation of shock transmission units was found to be a very prudent solution for major and heavy structures, like the Marquam and Abernathy bridges.

Installing shock transmission units increases the retrofit cost significantly compared to installing seismic restrainers, but it provides a higher level of earthquake resistance. It has been applied only on a few major bridges.

The actual cost data for retrofitted bridges show that the unit prices used by CH2M HILL were unconservatively low. The unit cost for Phase I retrofit projects turned out to be almost as expensive as the unit price used for Phase II retrofit in CH2M HILL’s estimate. One factor that had a significant influence on this outcome



Figure 6.3 : Shock Transmission Units were Installed in Abernathy Bridge as Part of The Seismic Retrofit

was the selection of individual bridges for retrofit instead of groups of bridges (i.e. bundles), based on their physical location. However, establishing bundles for retrofit projects was not an option due to the limited funding available.

In the past few years ODOT has gained experience in the best practices available for seismic retrofitting state bridges. Additionally, the Department was able to evaluate the influence of different options on project costs. For example, it was evident that retrofitting a bundle of bridges would be less expensive than retrofitting bridges individually (assuming the bridges were closely located), but a larger package would require additional funding.

Currently, there is not enough funding available for ODOT to retrofit all state bridges with seismic deficiencies. However, ODOT should not ignore current bridge and public safety vulnerabilities. For this reason, we have established a design policy to include at least a Phase I seismic retrofit for existing vulnerable bridges that are scheduled to undergo other types of rehabilitation. This method is very cost efficient since it reduces design and mobilization cost significantly, but is considered a temporary solution since it is a slow response to the actual large need. In fact, at this rate, many bridges will be replaced before they can be retrofitted, even though funding for bridge replacements is also expected to be limited.

As we are reminded by the latest earthquake strikes around the world, ODOT recognizes how devastating post-earthquake conditions might be for Oregon. We have also seen that a bad situation can get even worse if emergency response is not able to reach those in need due to logistical problems caused by a nonfunctional highway network. Valuable time lost in responding to emergency situations will be compounded if we lose several bridges along a vital route.

In an effort to minimize this possibility, ODOT has chosen to be proactive in evaluating Oregon bridges and their performance level under the most common earthquake scenarios. Utilizing the data collected from seismic hazard analysis conducted using REDARS2 and additional data available in ODOT's database, the Bridge Section has the ability to move toward a strategy for evaluating, prioritizing and mitigating the seismic vulnerabilities of state bridges.

After selecting the major earthquake scenarios that have a reasonable probability of occurrence in Oregon, we have analyzed these earthquake scenarios using REDARS2 to show the affected areas, and determine which are the most vulnerable segments on our highway system. With the majority of bridges built before the availability of seismic design specifications, the extent of the problem or needs identified by REDARS2 was not surprising, leaving the Agency with the burning question of "where do we go from here?"

ODOT recognizes that retrofitting all vulnerable bridges in the near future is not an option, but we can find ways to start moving in that direction. Under these circumstances, the prioritization process of major highway segments, or key individual bridges, that are vulnerable under seismic loading will be important and necessary.

Giving all earthquake scenarios a similar chance of occurrence in the near future, ODOT estimated the economic losses of each major highway segment under different earthquake scenarios. These economic losses include the cost to repair or replace all bridges damaged from the earthquake, as well as the cost of travel time losses. Because of uncertainty of which earthquake may strike first, the maximum damage cost for different earthquake scenarios was assigned to each highway segment (see Table 6.1). These costs will be an important factor in determining the priority of each segment to be retrofitted.

Table 6.1 : Route Maximum Earthquake Losses

Route	Bridge Damage Cost + Travel Cost Losses from Different Earthquake Scenarios (in million \$)						Maximum Earthquake Loss (in million \$)
	CSZ 9.0	CSZ 8.3 North	CSZ 8.3 South	Portland Hills 6.5	Scotts Mills 7.0	Klamath Falls 7.0	
I-5 (Multnomah-Clackamas)	\$13.94	\$0.45	\$0.00	\$511.78	\$0.00	\$0.00	\$511.78
I-5 (Marion-Linn)	\$20.33	\$5.66	\$9.33	\$0.00	\$0.00	\$0.00	\$20.33
I-5 (Lane-Jackson)	\$6.20	\$0.00	\$5.83	\$0.00	\$0.00	\$0.00	\$6.20
I-84	\$5.45	\$2.25	\$0.00	\$181.14	\$0.00	\$0.00	\$181.14
US-101	\$771.96	\$256.92	\$259.25	\$0.00	\$0.00	\$0.00	\$771.96
US-26	\$13.79	\$1.11	\$0.00	\$67.72	\$0.00	\$0.00	\$67.72
I-205	\$18.39	\$1.13	\$0.00	\$14.94	\$0.00	\$0.00	\$18.39
I-405	\$3.08	\$0.00	\$0.00	\$335.97	\$0.00	\$0.00	\$335.97
US-30	\$32.03	\$18.63	\$0.00	\$124.27	\$0.00	\$0.00	\$124.27
US-20	\$21.05	\$13.21	\$1.21	\$0.00	\$0.00	\$0.00	\$21.05
OR-38	\$9.20	\$1.00	\$7.30	\$0.00	\$0.00	\$0.00	\$9.20
OR-42	\$164.36	\$5.09	\$144.71	\$0.00	\$0.00	\$0.00	\$164.36
Others*	\$177.22	\$38.25	\$31.37	\$409.17	\$43.00	\$112.00	\$409.17

In an effort to better utilize any future funding for seismic retrofit, ODOT has attempted to capture the major factors that would make the prioritization process reasonable and understandable. The preliminary results of the algorithm used by ODOT to prioritize the seismic retrofit strategy are shown on Table 6.2.

It seems intuitive that improving longer stretches of highways with lower costs would be a key criteria in prioritizing the system. But ignoring the most populated areas of our state would not be astute. This is why ODOT has considered both the Route Length and the Average Daily Traffic to be very important factors in the retrofit prioritization process.

Acknowledging the financial constraints of today's economy, ODOT has weighted Retrofit Cost heavily, as a determining factor for allocating any future funding. Furthermore, the Retrofit Cost has been compared to the Maximum Earthquake Loss for the same highway segment. This is intended to avoid selecting one route over another solely because its retrofitting cost is less than others.

Table 6.2 : Preliminary Route Seismic Retrofit Prioritization Ranking

Route	Route Length Traffic (in miles)	Average Daily Bridges (in vehicles)	Number of Bridges	Maximum Earthquake Loss (in million\$)	Phase I Retrofit Cost (in million\$)	Phase II Retrofit Cost (in million\$)	Total Retrofit Cost (in million\$)	Pre-liminary Priority Index
I-5 (Multnomah-Clackamas)	27.84	155,800	95	\$511.78	\$125.00	\$321.00	\$446.00	1
I-405	4.21	113,400	50	\$335.97	\$53.00	\$137.00	\$190.00	2
I-84	149.65	171,400	290	\$181.14	\$142.00	\$366.00	\$508.00	3
OR-42	77.17	24,800	54	\$164.36	\$24.00	\$61.00	\$85.00	4
US-30	99.34	48,695	38	\$124.27	\$23.00	\$59.00	\$82.00	5
US-26	128.87	152,000	133	\$67.72	\$46.00	\$117.00	\$163.00	6
US-101	363.11	27,000	143	\$771.96	\$103.00	\$264.00	\$367.00	7
I-5 (Marion-Linn)	77.26	94,900	215	\$20.33	\$84.00	\$215.00	\$299.00	8
I-205	27.18	176,225	76	\$18.39	\$114.00	\$294.00	\$408.00	9
OR-38	57.23	4,700	16	\$9.20	\$5.00	\$12.00	\$17.00	10
US-20	76.80	22,700	80	\$21.05	\$19.00	\$49.00	\$68.00	11
I-5 (Lane-Jackson)	203.55	50,200	166	\$6.20	\$82.00	\$211.00	\$293.00	12

Striving to optimize the algorithm for seismic prioritization, ODOT has included a variety of other important factors that have an influence on the efficiency of the program. Aware that part of our highway system will be heavily damaged due to severe landslides in an earthquake, it is probably not prudent to spend money retrofitting old bridges along these segments. Even if bridges in areas prone to landslides survive an earthquake, it would take time to re-establish roadway approaches. Other factors, such as importance of a route for freight movements, inter-state borders, and major river crossings, are considered important factors of the algorithm.

It is important to understand the results of this report are the product of a preliminary study by the Bridge Section of ODOT, intended to reflect the vulnerability of state-owned bridges and to highlight the approximate funding needed to retrofit them. ODOT understands these results will be further refined by stakeholder involvement and additional study. This report is intended to disseminate currently available information and to stimulate conversation or debate on new strategies or responses. A wider review by other ODOT sections,

such as Roadway, Freight Mobility, Maintenance, Operations and Planning, can provide valuable input that would help the Bridge Section in the future refinement of this report. Furthermore, Bridge Section will complete a more refined study, which will analyze each individual bridge on identified vulnerable routes. This Phase 2 report will allow ODOT to make specific recommendations on seismic retrofit priorities, considering the factors mentioned in this report and other more detailed considerations.

The vulnerability of Oregon bridges is a real concern, and ODOT understands what it takes to mitigate it. However, ODOT recognizes that a wider audience must be engaged in determining the optimum bridge mitigation strategy to protect public safety and infrastructure investments.

RECOMMENDATIONS

- 1. In the short term continue to refine the Oregon State Highway Bridge Seismic Vulnerability and Mitigation Strategy report by working with stakeholders to define the highest priority and most cost effective mitigation strategies and routes.*
- 2. Publish this initial Report widely to communicate and educate stakeholders and highway users on potential damage and options for mitigation.*
- 3. Continue the strategy of including Phase I seismic retrofit to bridge repair and rehabilitation projects in the Statewide Transportation Improvement Plan (STIP).*
- 4. Add Phase I seismic retrofit as a selection criteria in the Major Bridge Maintenance program for a few of the highest priority bridges as a way to begin some making progress in achieving a minimum level of seismic safety on the Interstate of other essential routes.*
- 5. Add seismic mitigation as one of the selection and prioritization criteria in the Bridge Program of the STIP.*
- 6. Provide support to update the existing designation of lifeline routes.*
- 7. Work with stakeholders to define a long term comprehensive study of seismic vulnerability and risk for the entire transportation system to develop an overall perspective on resulting mobility and essential service related impacts after a major seismic event. Include consideration of landslides and highway fills, local roads systems, and access to critical facilities such as fuel depots and utility delivery systems. This study will be useful to fully understand the seismic risks facing the State.*

REFERENCES

1. Page 11

Jacob Arnold, "Big earthquake coming sooner than we thought, Oregon geologist says", The Oregonian, April 19, 2009

2. Page 13

"Seismic Zonation for Highway Bridge Design", Washington Department of Transportation, Report WA-RD 172.1, December 1988

3. Page 14

"Seismic Design Mapping", State of Oregon, Geomatrix Consultants, prepared for Oregon Department of Transportation, Salem, OR 97310, Personal Services Contract 11688, January, 1995, Project No. 2442.

4. Page 32

Youngs, R.R., S.J. Chiou, W.J. Silva, and J.R. Humphrey (1997). "Strong ground motion attenuation relationships for subduction zone earthquakes", Seism. Res. Letters, v. 68, no. 1, pp. 58-73

APPENDIX A

Additional Notes on REDARS 2 Model

Earthquake Impacts on Highways

In the scenarios considered, highways I-5, I-84, US-101, I-405, US-26, US-20, US-30, OR-38, and OR-42 have extensive damage or collapse. Other local bridges not currently incorporated into the model are also likely to experience damage as well as failure of the roadways due to other earthquake related affects including potential land slides and liquefaction.

Impacts – Immediate

Bridges represent vulnerability points within a transportation network. Hence, damaged bridges will have a great impact on the system performance causing severe traffic congestion statewide. This disruption of traffic flow will in turn impact post-earthquake emergency response, repair and reconstruction operations.

Recovery Issues

Single bridges on some major routes may be replaced with in a year. However, it will probably take over 5 years to replace 70+ bridges due to limited resources. Another issue in recovery of the network system is that some streets cannot carry the increased traffic volumes that could possibly be diverted to them.

Impacts – Long term

Severe traffic congestion will occur for at least a year. Movement of goods to final destinations – for example, manufacturers, retail outlets, and hospitals- will be much slower for a long period of time. This will have long term economic consequences due to the valued loss of time when commuter and freight travel slows down due to the disrupted network. A commute to work that took 30 minutes could take hours; and businesses will suffer due to this disruption and may even move from Oregon elsewhere.

Analysis results and interpretation

Damage states of bridges are computed by first computing the bridge's demand spectral acceleration for a given scenario earthquake, it is then compared to each bridge's spectral acceleration capacity that leads to the onset of each damage state. However, these median values of ground motion computed do not necessarily represent the exact levels of ground shaking at the bridge locations since the exact levels of ground shaking of an earthquake will not be known without actually recording the motion with strong motion accelerators at the time of the event. Consequently, there is a probability that some bridges might perform better or worse during a real earthquake compared to a scenario analysis. In addition, fragility values are based on probabilistic median expected performances. A particular bridge that had a specific damage state may not exactly correlate to actual events but is more representative as the expected damage state. For these reasons, the aggregate response over the route should be examined and is more informative than considering the damage state of an individual bridge.

Study Limitations

1. The Study only applies to state-owned bridges in western Oregon, Klamath Falls area and the western and central Columbia River Gorge. No consideration of possible failures of landslides and fills on state highways or of local roads and bridges was included.
2. The relative probability of occurrence of the six earthquake scenarios was not considered in the prioritization of route segments.
3. The study does not consider settlement or lateral spreading due to liquefaction.
4. Traffic costs include the cost to reroute traffic to other open state highways, but not to the local road system.
5. The algorithm used to prioritize route segments does not consider the relative probability of occurrence of the representative earthquakes.



SEISMIC VULNERABILITY OF OREGON STATE HIGHWAY BRIDGES

Mitigation Strategies To Reduce Major Mobility Risks

Oregon Department of Transportation
Bridge Engineering Section
November 2009

Acknowledgements:

This report was prepared by the ODOT Bridge Seismic Committee
(Albert Nako, Craig Shike, Jan Six and Bruce Johnson)
with assistance from Portland State University (Peter Dusicka and Selamawit Mehary).
Editing and publishing was done by Dawn Mach and Chittirat Amawattana.



Seismic Vulnerability of Oregon State Highway Bridges

Mitigation

**Strategies to
Reduce Major Mobility**

Risks



Oregon
Department of
Transportation