

A gray silhouette of the state of Oregon with a torn-paper edge effect. The text "SELF-ISSUE PERMIT PROGRAM (SIPP)" is centered within the map in a black, serif font.

SELF-ISSUE PERMIT PROGRAM (SIPP)

Last Revised November 2023



Commerce and Compliance Division

Table of Contents

Introduction.....	4
What is Legal?	
Solo Vehicle.....	7
Combination of Vehicles.....	8
Weight.....	9
Load Length, Width, and Height.....	10
Weight Tables and Samples.....	11
Trailer Types and Extensions.....	22
What is Permittable By Self-Issue?	
Solo Vehicles.....	25
Truck Tractor/Semitrailer Combinations.....	26
Tow Vehicles.....	28
Self-Propelled Vehicles.....	30
Self-Propelled Vehicle with Booster or Dolly Axles.....	31
Mobile/Modular Units.....	33
Truck Tractor/Semitrailer Overlength.....	34
Heavy Haul Combinations.....	36
Routing.....	
Road Restrictions.....	38
Weight Restrictions.....	39
Length.....	42
Width.....	43
Height.....	44
Non-ODOT Jurisdiction Roads.....	45
Straddle Centerline.....	47
State Routes with Additional Restrictions.....	48
Direction of Travel.....	51
Other Considerations.....	53
How to Add Pilot Vehicles.....	56
How to Add Road Restrictions.....	58
Permit Provisions.....	60

List of Maps and Attachments	62
Application Instructions	
S01 – Truck Tractor/Semitrailer, Legal Weights	64
S03 – Truck Tractor/Semitrailer, Heavy Haul Weights	73
S09 – Mobile Unit	82
S09 – Modular Unit	86
S18 – Tow Vehicle	92
S30 – Truck Tractor/Semitrailer Overlength	98
S35 – Self-Propelled Vehicle with Boom Dolly	106
S37 – Self-Propelled Vehicle (Weight Table 3)	111
S38 – Self-Propelled Vehicle (Weight Table 4)	116
S39 – Heavy Haul Combination	120
S43 – Solo Vehicle	128
Appendices	
Appendix A – Height Restrictions	134
Appendix B – Exit Numbers	135
Appendix C – County Contact Information	146

Introduction

Program Purpose

The Self-Issue Permits Program (SIPP) is to aid industry by allowing self-issuance of single-trip permits to save time and money, while protecting the traveling public, the highway system and structures from potential damage. Rules for this program are described in [Oregon Administrative Rules Chapter 734, Division 72](#).

Program Goal

Successful completion of this training program will allow participants the ability to issue single trip over-dimension permits for the movement of single, non-divisible loads.

Maximum Dimensions Allowed on Self-Issued Permits

Width

- 12 feet wide on green and purple routes on [Route Map 2](#).
- 14 feet wide on black routes on [Route Map 9](#) (or [Map 6](#) for mobile/modular units).

Height

- 15 feet 00 inches high, based on vertical clearance routing.

Weight (Non-Divisible Load)

- 21,500 pounds per single axle.
- 43,000 pounds per tandem axle.
- 200,000 pounds gross weight.
- Tire, axle and group axle weights shown in [Weight Table 4](#).

Weight (Divisible Load)

- 20,000 pounds per single axle.
- 34,000 pounds per tandem axle.
- 80,000 pounds gross weight.
- Tire, axle and group axle weights shown in [Weight Table 1](#). **Note:** in most cases, SIPP permits can be used in conjunction with a valid extended weight permit ([Weight Table 2](#)) issued to the power unit.

Overall Length

- 140 feet overall length for truck tractor with trailer in float position.
- 120 feet overall length for heavy haul combinations or tow vehicle combinations.
- 110 feet overall length when towing a mobile home or hauling a modular unit.
- 105 feet overall for truck tractor/semitrailer combinations.
- 50 feet overall length for solo vehicles.

Self-Propelled Vehicle Length Limits

- 55 feet vehicle length.
- 120 feet overall length when in combination (i.e., with a boom dolly).

- 75 feet overall length when towing a dolly, pickup truck, passenger vehicle or trailer.
 - Vehicles being towed by the self-propelled vehicle must be legal weight and not more than 20 feet in length.

Refer to permit guides for permissible trailer length, load length and overhang length limits.

Requirements of Motor Carriers for Initial Certification in Self-Issue Permits Program

- Have an established CCD Account, register for TOL and be approved to charge fees to the CCD Account.
- Successfully complete a training program administered by the Over-Dimension Permit Unit.
- Have purchased a minimum of 125 single trip permits for oversize/overweight movements within the 12 months preceding the application.
- Sign an agreement of responsibility for the permitted moves.
- Have no more than one late highway use tax report or Road Use Assessment Fee (RUAF) mileage report in the 12 months preceding the application.
- Have maintained current vehicle and tax registration with the Department during the 12 months preceding application.
- Have no suspensions of CCD Account with the Department during the 12 months preceding the application.
- Have no more than one late payment of OD fees due in the 12 months preceding the application.
- Have no more than a fifteen percent underpayment finding on the most current weight-mile tax audit.
- Have no incidents involving damage or potential damage to any roadway, roadway device, or structure resulting from an oversize/overweight permitted movement during the past 12 months preceding the application.
- Have a satisfactory safety rating with the USDOT FMCSA, or ODOT CCD.
- Filing proof of general liability insurance with the Commerce and Compliance Division (Intrastate carriers only).

Requirements of Motor Carriers for Recertification in Self-Issue Permits Program

- Have an established CCD Account, register for TOL and be approved to charge fees to the CCD Account.
- Sign an agreement of responsibility for the permitted moves.
- Not have more than one late highway use tax report or Road Use Assessment Fee (RUAF) mileage report in the 12 months preceding the application.
- Have maintained current vehicle and tax registration with the Department during the 12 months preceding application.
- Have no suspensions of tax registration with the Department during the 12 months preceding the application.
- Have no more than one late payment of fees due in the 12 months preceding the application.

- Have no more than a fifteen percent underpayment finding on the most current weight-mile tax audit.
- Have no incidents involving damage or potential damage to any roadway, roadway device, or structure resulting from an oversize/overweight permitted movement during the past 12 months preceding the application.
- Have a satisfactory safety rating with the USDOT FMCSA, or ODOT CCD.
- Filing proof of general liability insurance with the Commerce and Compliance Division (Intrastate carriers only).
- Self-issued permits are issued in conformance with the program.

Process of Certification and Recertification in the Self-Issue Permits Program

- Initial certification will last up to 6 months. Before this certification expires, CCD still will review permits issued for conformance with the program, and review other requirements as described above.
- Subsequent certification will last up to 2 years. Approximately 3 months before this certification expires, carriers will be notified.
- The carrier's authorization to self-issue may be canceled if the certification requirements described above are not maintained.

What is Legal?

Before understanding what loads require a permit, we need to understand what legal size and weight is in Oregon. Oregon Revised Statutes describes these limits, primarily [Chapter 818](#).

What is Legal — Solo Vehicle:

- Width – 8 feet, 6 inches.
- Height (including load) – 14 feet, 00 inches.
- Front overhang* – 4 feet.
- Rear overhang** – 3/4 wheelbase.
- Load length – 40 feet.
- Overall length – 40 feet including load.

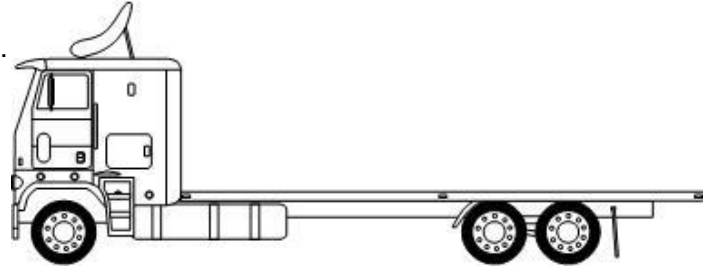

* Front overhang measured from the front of vehicle or bumper.

** Rear overhang measured from center of last axle to end of load.

Exceptions

- Recreational vehicle allowed 45 feet overall length. [ORS 818.100\(16\)\(a\)](#).
- Motor vehicle transporter allowed 45 feet overall length. [ORS 818.100\(17\)](#).

What is Legal — Combination of Vehicles:

- Width – 8 feet, 6 inches.
- Height (including load) – 14 feet, 00 inches.
- Front overhang * - 4 feet.
- Rear overhang ** - 1/3 wheelbase.
- Load length – 40 feet.
- Overall length 60 feet – including load.
- No vehicle in combination can exceed 40 feet in length.

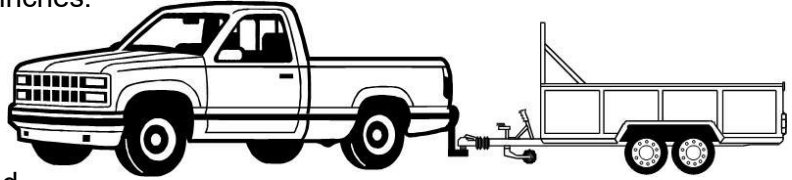

* Front overhang measured from the front of vehicle or bumper.

** Rear overhang measured from center of last axle to end of load.

Exception

- A combination that includes a recreational vehicle that is not more than 45 feet in length is allowed to be up to 65 feet in overall length on most state highways.

What is Legal — Other Combination Types

Trailer length and overall length for other combinations, including truck-tractor/semitrailers, doubles, truck and trailer, etc., are documented on the back of [Group Map 1](#).

Truck Tractor/Semitrailer combinations, Doubles, and pickup and trailer combinations may be allowed longer overall lengths, depending upon the length of the trailer, and the specific route traveled. See the back of [Route Map 7](#) for designated routes and restrictions.

If the trailer length, load length, or overall length exceed the lengths shown above, the maximum rear extension is 5 feet, measured from the back of the trailer, as long as overall length limits for that highway are not exceeded. Flags (daytime hours) or lights (during hours of darkness, or when visibility is less than 500 feet) are required if the load extends more than 4 feet off the back of the trailer.

Legal Weight ([Weight Table 1](#))

The loaded weight of any group of axles, vehicle, or combination of vehicles shall not exceed any of the following:

- 600 pounds per inch of tire width.
- 20,000 pounds on any one axle, including any one axle of a group of axles.
- 34,000 pounds on any tandem axle.
- Axle and group axle weights as shown on [Weight Table 1](#).
- 80,000 pounds gross weight.
- The sum of the permissible axle, tandem axle, or group of axle weights, whichever is less.

Four exemptions are allowed. Depending upon which roads are used, an annual extended weight permit may be required for Exemptions 1 and 2.

Exemption 1: Two consecutive tandem axles may weigh up to 34,000 pounds each if:		
Minimum Axle Spacing Required	Interstate Highways	Non-Interstate Highways
30 feet or more	Permit Required	No Permit Required
36 feet or more	No Permit Required	No Permit Required

Exemption 2: A group of four axles consisting of a set of tandem axles and two axles spaced 9 feet or more apart may have a loaded weight of more than 65,500 pounds and up to 70,000 pounds if:		
Minimum Axle Spacing Required	Interstate Highways	Non-Interstate Highways
35 feet or more	Permit Required	No Permit Required

Exemption 3: An additional 2000 pounds above the weights shown on Weight Table 1 is allowed for a vehicle that uses natural gas as its fuel source.
--

Exemption 4: An additional 550 pounds above the weights shown on Weight Table 1 is allowed for fully functional idle reduction systems.
--

Legal Load Length

Legal load length is 40 feet.

The load can be longer than 40 feet when hauled on a semitrailer, as long as the load does not extend beyond the rear of the semitrailer by more than 5 feet. Vehicle and load are still subject to legal overhang and overall length. Loads longer than 40 feet and hauled on a trailer or semitrailer cannot extend forward of the rear of the cab, unless authorized by single-trip permit. Load length up to 40 feet can extend forward of the rear of the cab without a permit.

Legal Width

Legal width in Oregon is 8 feet, 6 inches. Multiple items cannot be loaded side by side and exceed legal width.

Legal Height

Legal height in Oregon is 14 feet 0 inches. Multiple items cannot be stacked on top of each other and exceed legal height.

Extended Weight ([Weight Table 2](#))

Extended weights are legal axle weight loads with a gross weight exceeding 80,000 pounds, up to 105,500 pounds. An extended weight permit is required. Extended weights are only valid with a minimum of 47 feet of wheelbase and 5 axles, and other group axle weights allowed in [Weight Table 1](#).

Weight Table 1 Sample #1

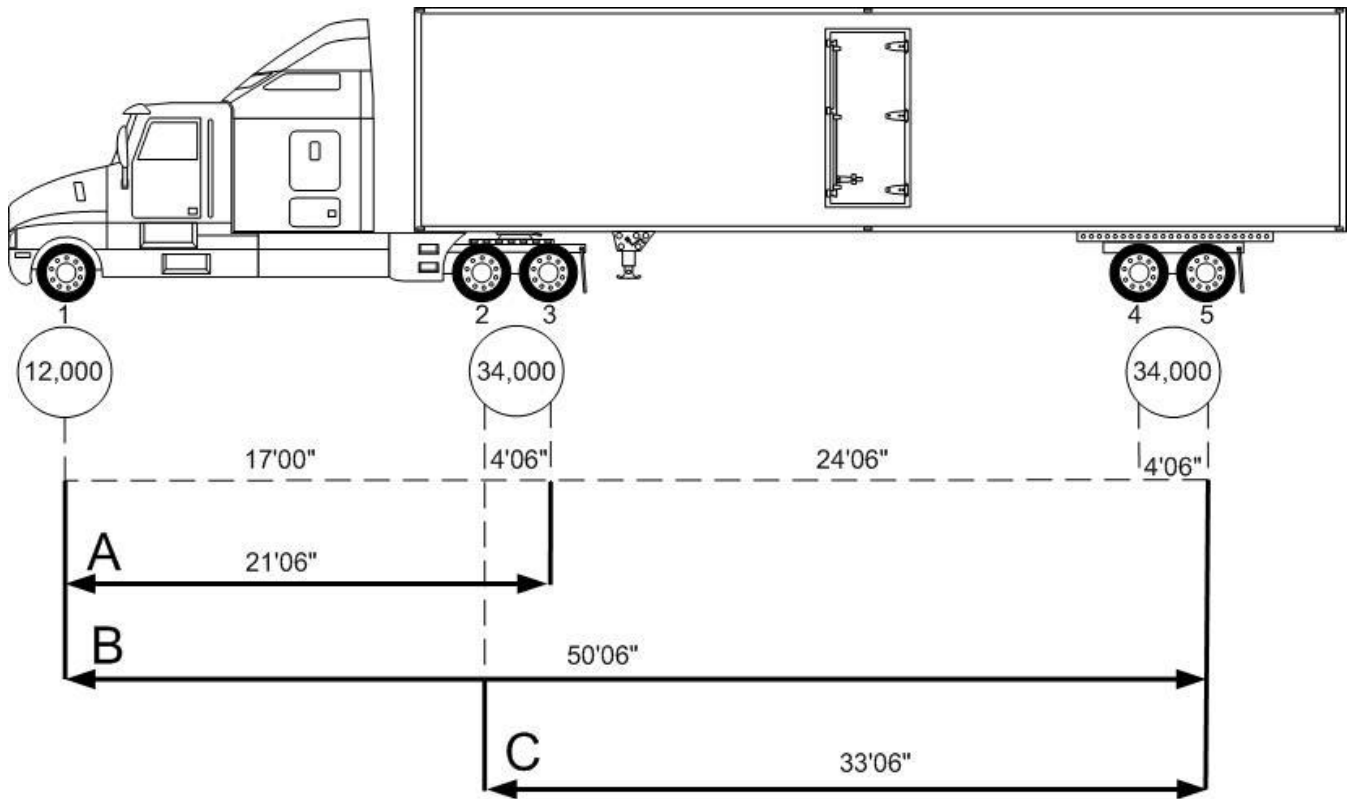

	Axles	Spacing	Table Allows	Requested
A	1-3	21'06"	52,500	46,000
B	1-5	50'06"	80,000	80,000
C	2-5	33'06"	*64,500	*68,000

*See Exception 1: A permit is required for this vehicle combination only on the Interstate highway system, otherwise, none required.

Exception 1: Two consecutive tandem axles may weigh up to 34,000 pounds each if:		
Minimum Axle Spacing Required	Interstate Highways	Non-Interstate Highways
30 feet or more	Permit Required	No Permit Required
36 feet or more	No Permit Required	No Permit Required

Weight Table 1 Sample #2

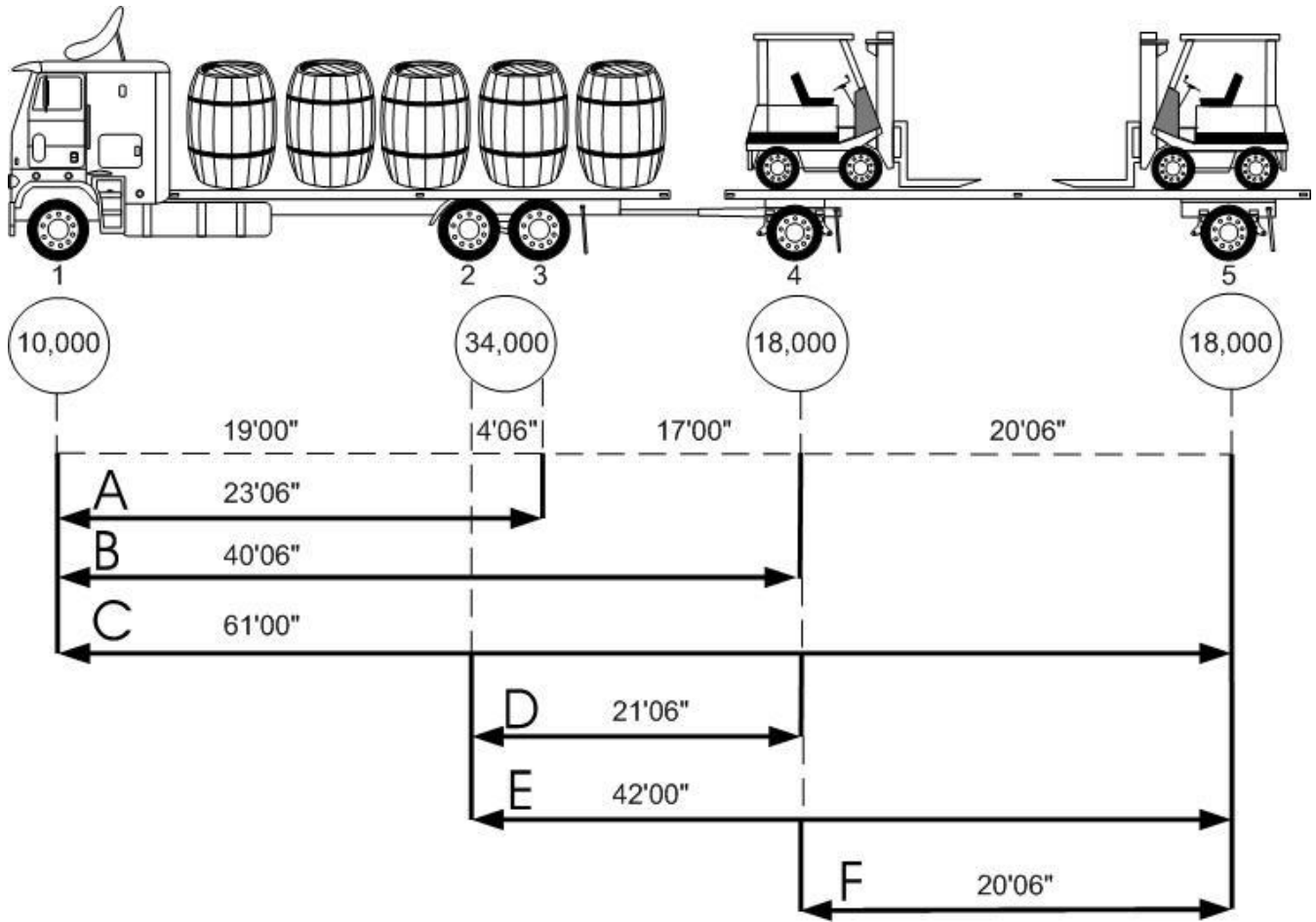

	Axles	Spacing	Table Allows	Requested
A	1-3	23'06"	54,000	44,000
B	1-4	40'06"	69,500	62,000
C	1-5	61'00"	80,000	80,000
D	2-4	21'04"	52,500	52,000
E	2-5	42'00"	70,000	70,000
F	4-5	20'06"	40,000	36,000

No overweight permit is required for this combination.

Weight Table 2 Sample #1

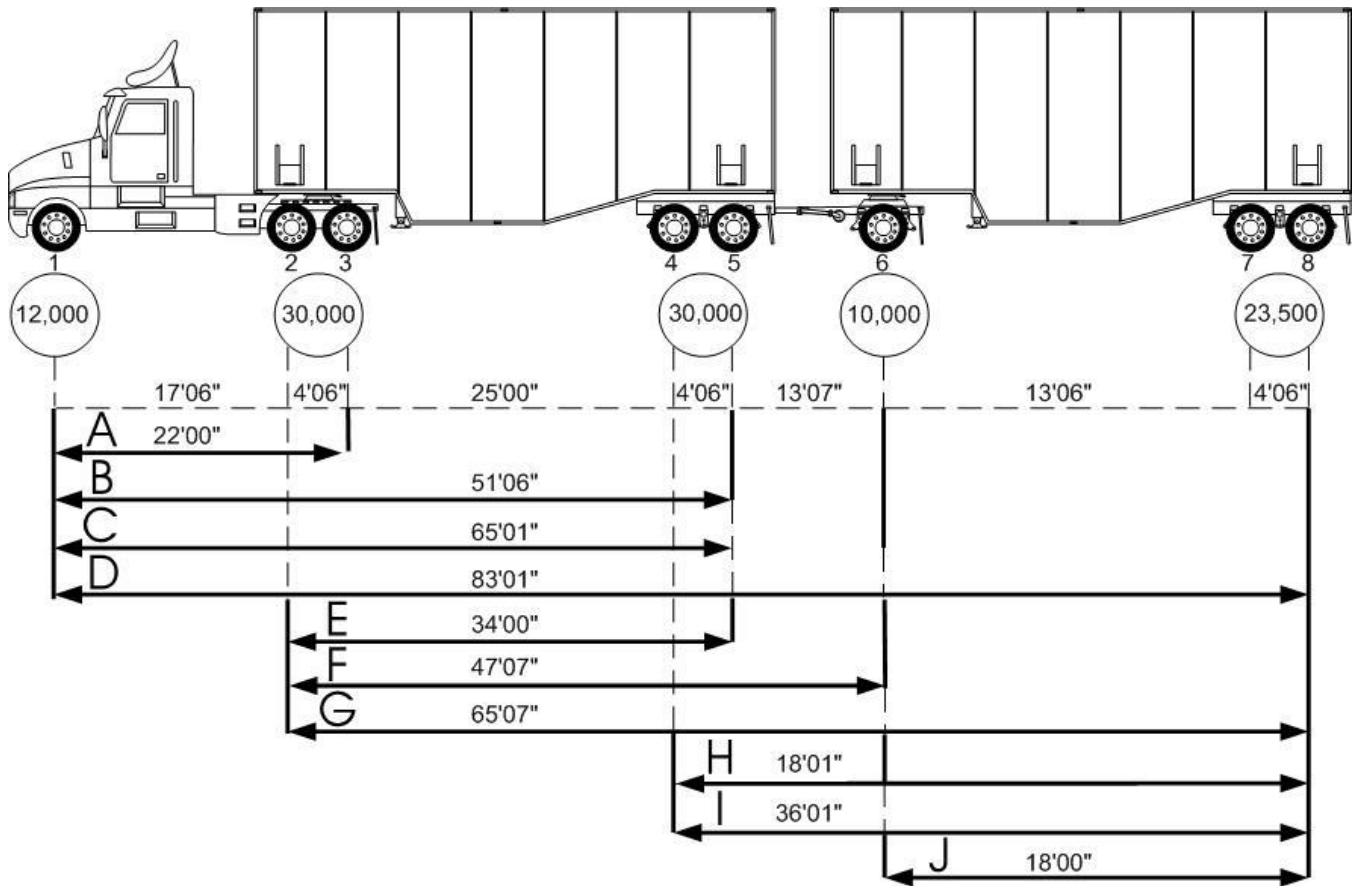

	Axles	Spacing	Table Allows	Requested
A	1-3	22'00"	52,500	42,000
B	1-5	51'06"	80,500	72,000
C	1-6	65'01"	93,000	82,000
D	1-8	83'01"	105,500	105,500
E	2-5	34'00"	64,500	60,000
F	2-6	47'07"	78,000	70,000
G	2-8	65'07"	98,500	93,500
H	4-6	18'01"	49,500	40,000
I	4-8	36'01"	70,500	63,500
J	6-8	18'00"	49,500	33,500

An extended weight permit is required at the requested weights.

Weight Table 2 Sample #2

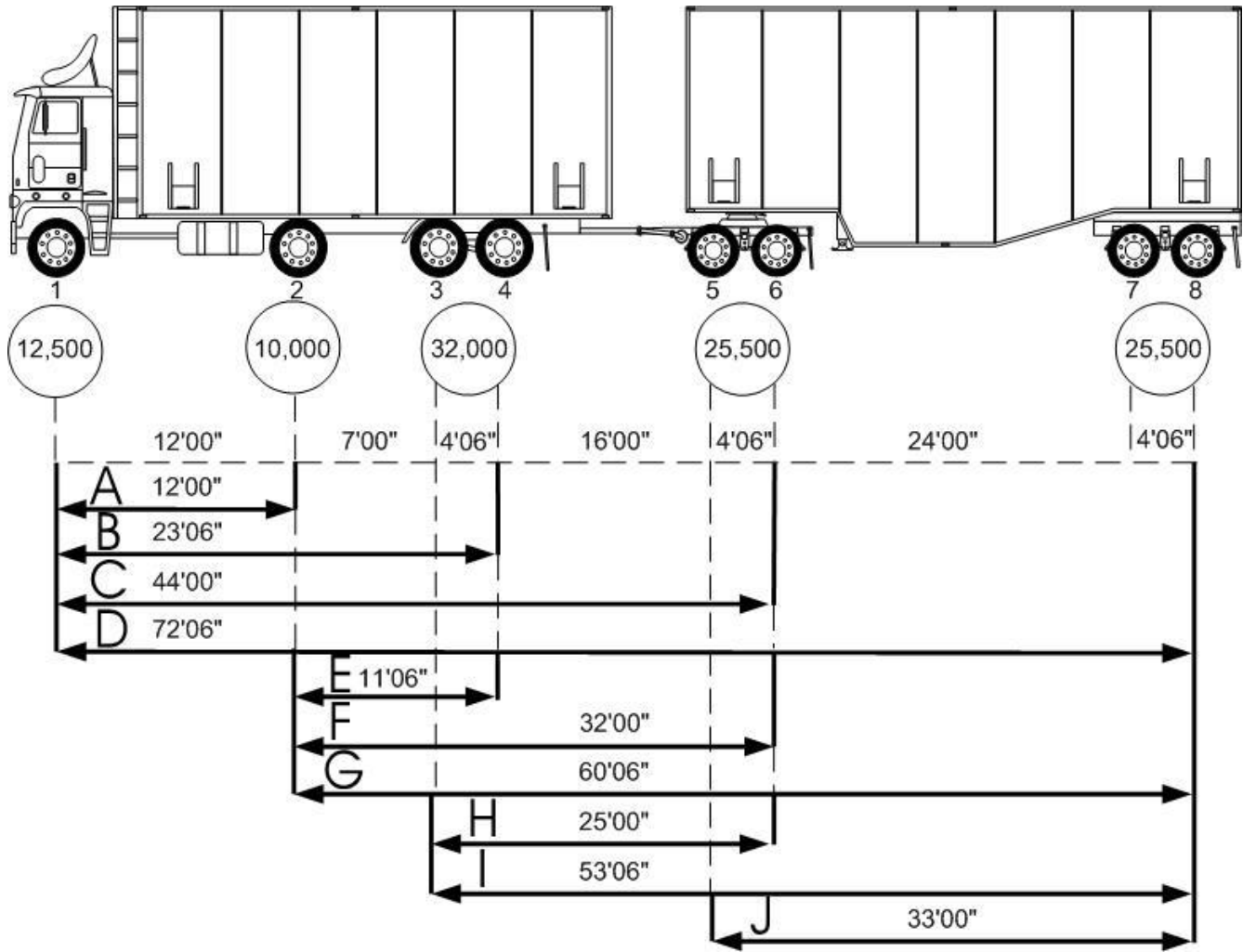

	Axles	Spacing	Table Allows	Requested
A	1-2	12'00"	40,000	22,500
B	1-4	23'06"	58,000	54,500
C	1-6	44'00"	80,000	80,000
D	1-8	72'06"	105,500	105,500
E	2-4	11'06"	45,000	42,000
F	2-6	32'00"	68,000	67,500
G	2-8	60'06"	95,000	93,000
H	3-6	25'00"	58,500	57,500
I	3-8	53'06"	86,500	83,000
J	5-8	33'00"	68,000	51,000

An extended weight permit is required at the requested weights.

Permit Weight Table 3

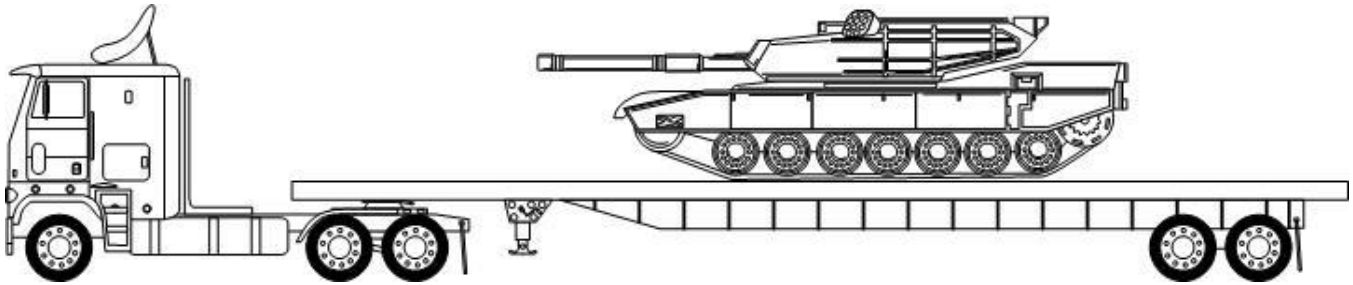

Permit [Weight Table 3](#) is based on two wheelbase weight formulas as described in [OAR 734-082-0005\(29\)](#):

- Formula 1: 1,000 times (the wheelbase in feet plus 40) for groups of axles, vehicles or combinations of vehicles having 18 feet or less of wheelbase.
- Formula 2: 1,200 times (the wheelbase in feet plus 40) for groups of axles, vehicles or combinations of vehicles having more than 18 feet of wheelbase.

Overweight permits are valid for **non-divisible loads** only. Permits do not authorize loads that:

- Can be readily or reasonably dismantled.
- Two or more items loaded side by side, stacked one upon the other, loaded end to end or staggered.
- Items that can be loaded at legal dimensions.

See [OAR 734-082-0005\(25\)](#) for additional definitions of non-divisible loads.

Permits cannot be issued for overweight for two or more items except for a machine with detached accessories included in the load, if:

- The accessories are detached to reduce width, height, length or a combination of these dimensions.
- An overweight permit could have been issued for the machine in its assembled condition.

The loaded weight of an axle, group of axles, vehicle, or combination of vehicles shall not exceed that specified in the permit weight table shown or any of the following:

- The tire manufacturer's sidewall rating.
- 600 pounds per inch of tire width.
- 21,500 pounds per single axle.
- 43,000 pounds per tandem axle.
- The weight shown on the permit.
- The sum of the permissible axle, tandem axle, or group axle weight, whichever is less.

By permit, unladen self-propelled or towed fixed-load vehicles equipped with low pressure flotation tires (15 inch or larger) shall be permitted 700 pounds per inch of tire width to a maximum of 36,000 pounds on any single axle, or 43,000 pounds on any tandem axle. These extra weights are not allowed in the [Self-Issue Permits Program](#). An annual permit is available, allowing up to 98,000 pounds gross weight. A single-trip permit issued by CCD is required if the gross weight exceeds 98,000 pounds.

Permit Weight Table 3 Sample #1

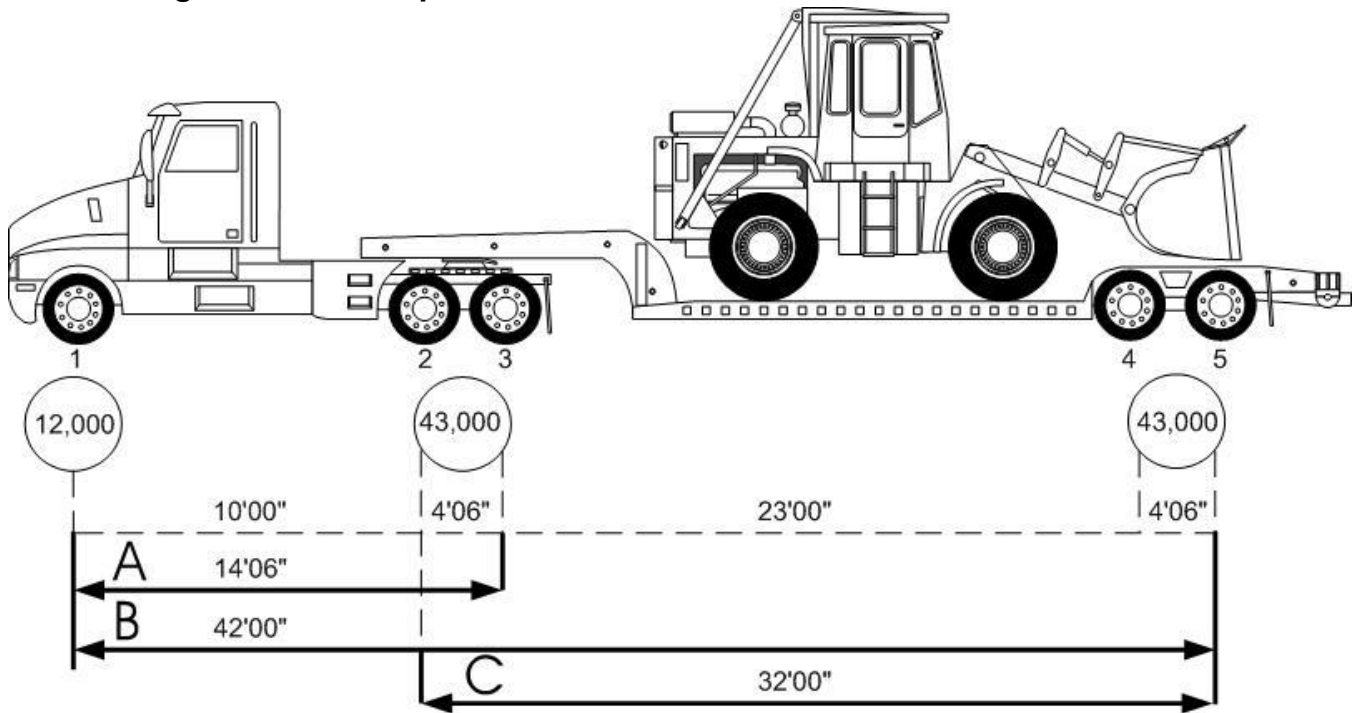

	Axles	Spacing	Table Allows	Requested
A	1-3	14'06"	55,000	55,000
B	1-5	42'00"	98,400	98,000
C	2-5	32'00"	86,000	86,000

An annual or single-trip permit is required for the requested weights. Movement over 98,000 pounds requires a single-trip permit. A self-issue permit is allowed for these weights.

Permit Weight Table 4

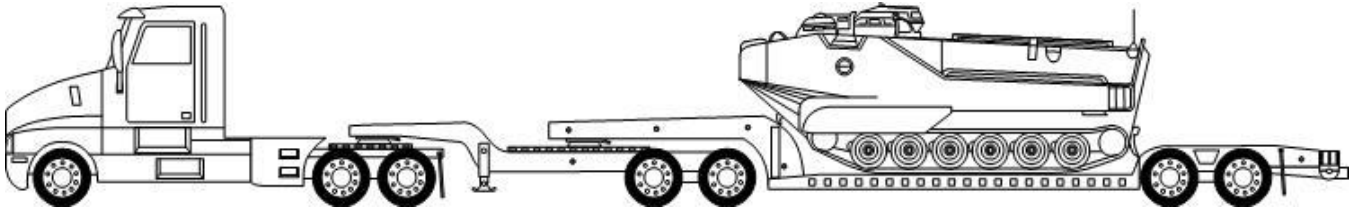

Permit [Weight Table 4](#) is based on three wheelbase weight formulas, as described in [OAR 734-082-0005\(30\)](#):

- Formula 1: 1,200 times (the wheelbase in feet plus 40) for groups of axles or combinations of vehicles having 9 feet 05 inches or less wheelbase.
- Formula 2: 2,200 times (the wheelbase in feet plus 20) for groups of axles or combinations of vehicles when the wheelbase is more than 9 feet 05 inches but less than 30 feet.
- Formula 3: 1,600 times (the wheelbase in feet plus 40) for groups of axles or combinations of vehicles when the wheelbase is more than 30 feet.

Overweight permits are valid for **non-divisible loads** only. Permits do not authorize loads that:

- Can be readily or reasonably dismantled
- Two or more items loaded side by side, stacked one upon the other, loaded end to end, or staggered
- Items that can be loaded at legal dimensions.

See [OAR 734-082-0005\(25\)](#) for additional definitions of non-divisible loads.

Permits cannot be issued for overweight for two or more items except for a machine with detached accessories included in the load, if:

- The accessories are detached to reduce width, height, length, or a combination of these dimensions.
- An overweight permit could have been issued for the machine in its assembled condition.

The loaded weight of a group of axles, vehicle, or combination of vehicles shall not exceed that specified in the permit weight table shown below:

- The tire manufacturer's sidewall rating.
- 600 pounds per inch of tire width.
- 21,500 pounds per single axle.
- 43,000 pounds per tandem axle.
- The weight shown on the permit.
- The sum of the permissible axle, tandem axle, or group axle weight, whichever is less.

By permit, unladen self-propelled or towed fixed-load vehicles equipped with low pressure flotation tires (15 inch or larger) shall be permitted 700 pounds per inch of tire width to a maximum of 36,000 pounds on any single axle, or 43,000 pounds on any tandem axle. These extra weights are not allowed in the [Self-Issue Permits Program](#). An annual permit is available, allowing up to 98,000 pounds gross weight. A single-trip permit issued by CCD is required if the gross weight exceeds 98,000 pounds.

Permit Weight Table 4 Sample #1

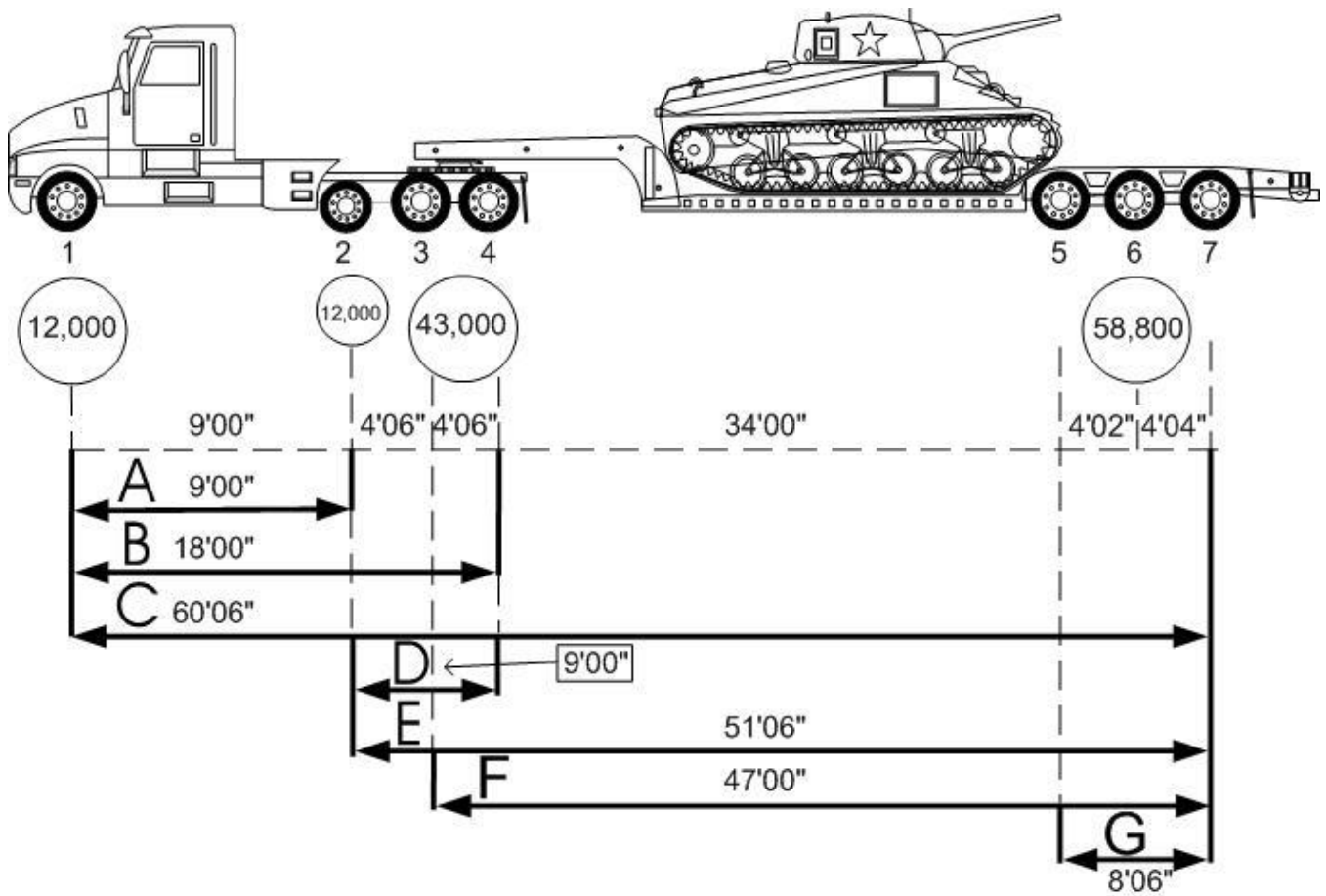

	Axles	Spacing	Table Allows	Requested
A	1-2	9'00"	43,000	24,000
B	1-4	18'00"	69,600	67,000
C	1-7	60'06"	141,400	125,800
D	2-4	9'00"	58,800	55,000
E	2-7	51'06"	128,800	113,800
F	3-7	47'00"	107,500	101,800
G	5-7	8'06"	58,800	58,800

A single-trip permit is required for this move. A self-issue permit is allowed for these weights.

Permit Weight Table 4 Sample #2

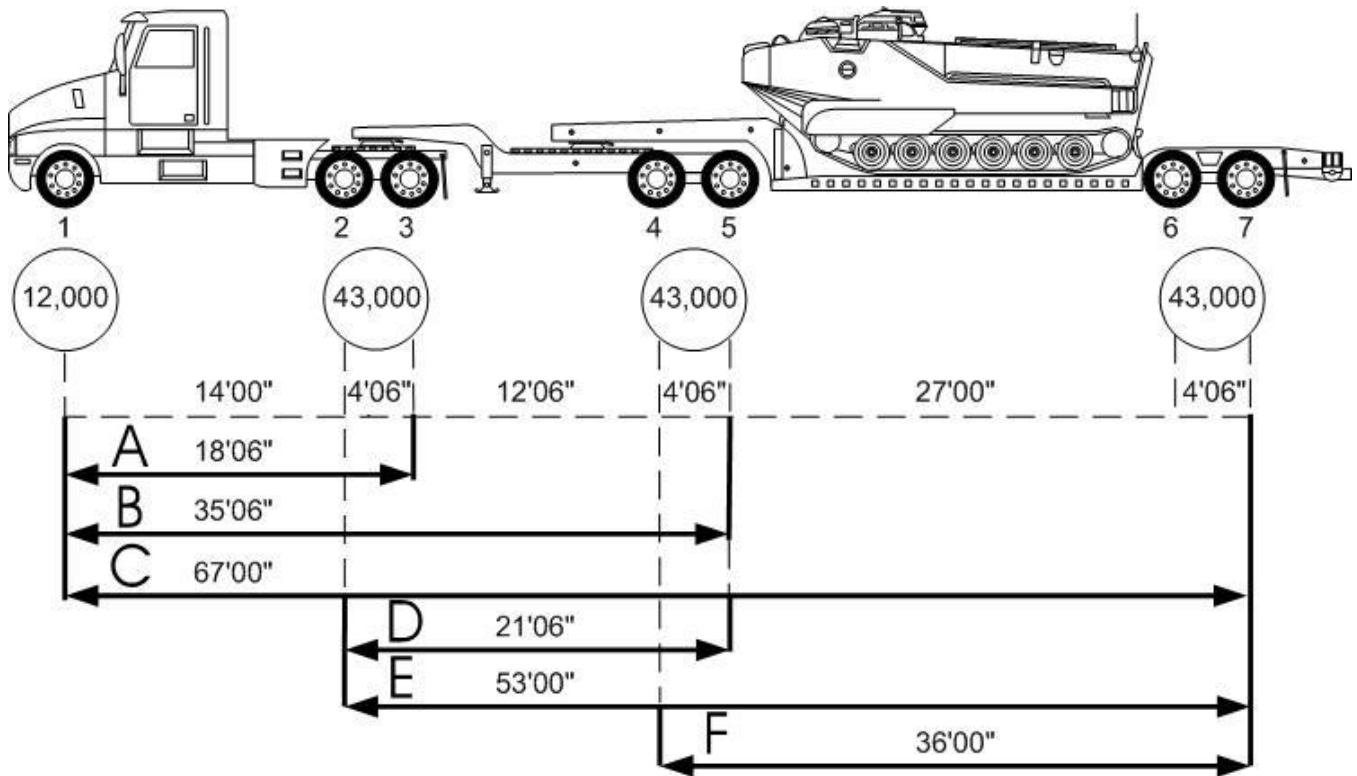

	Axles	Spacing	Table Allows	Requested
A	1-3	18'06"	64,500	55,000
B	1-5	35'06"	106,400	98,000
C	1-7	67'00"	149,800	141,000
D	2-5	21'06"	86,000	86,000
E	2-7	53'00"	129,000	129,000
F	4-7	36'00"	86,000	86,000

A single-trip permit is required for this move. A self-issue permit is allowed for these weights.

Permit Weight Table 4 Sample #3

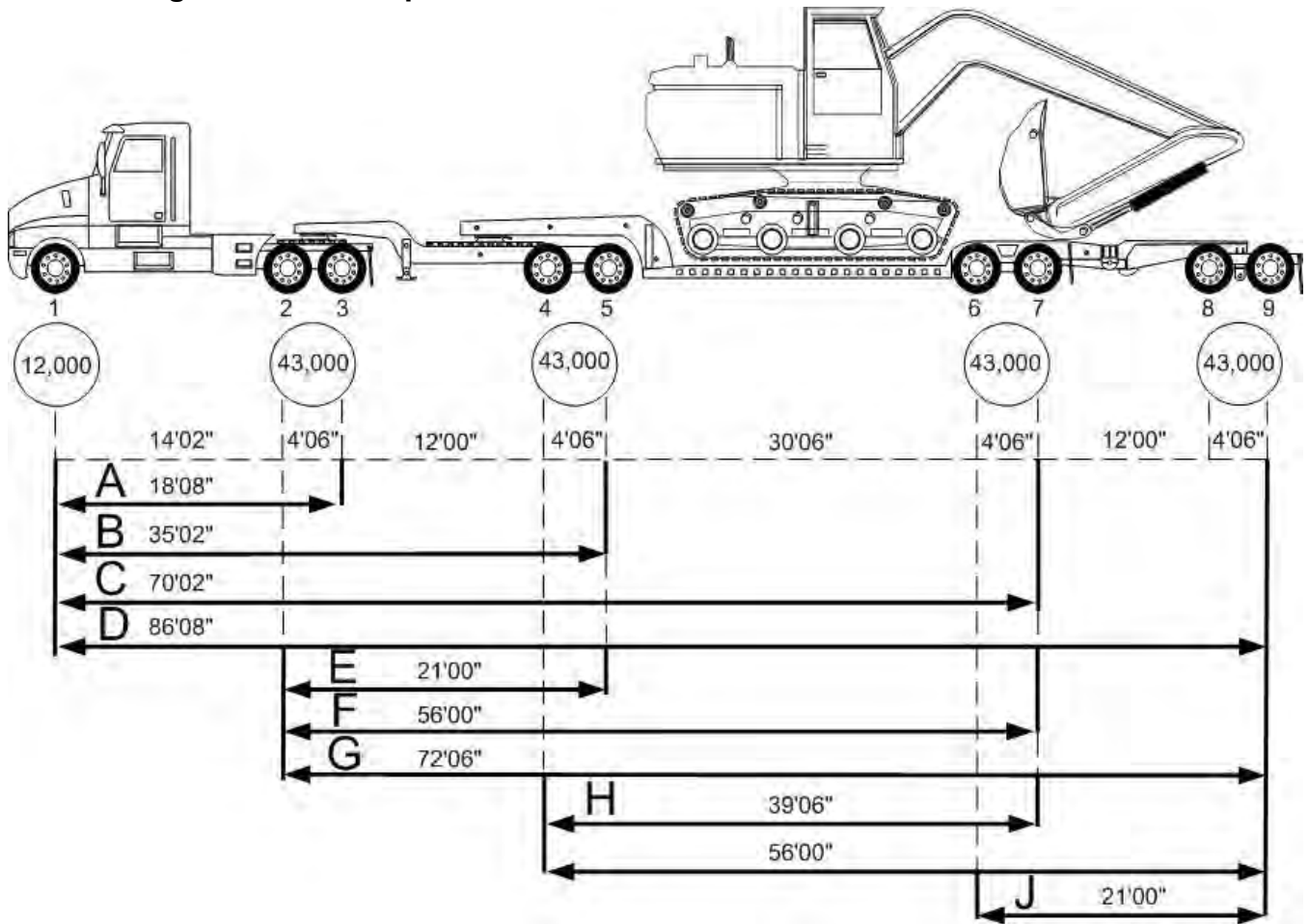

	Axles	Spacing	Table Allows	Requested
A	1-3	18'08"	64,500	55,000
B	1-5	35'02"	107,500	98,000
C	1-7	70'02"	150,500	141,000
D	1-9	86'08"	193,500	184,000
E	2-5	21'00"	86,000	86,000
F	2-7	56'00"	129,000	129,000
G	2-9	72'06"	172,000	172,000
H	4-7	39'06"	86,000	86,000
I	4-9	56'00"	129,000	129,000
J	6-9	21'00"	86,000	86,000

A single-trip permit is required for this move. A self-issue permit is allowed for these weights.

Permit Weight Table 5

Permit [Weight Table 5](#) is the same three formulas as Permit [Weight Table 4](#), but describes maximum weights up to 24,000 pounds per axle and 48,000 pounds per tandem axle when the combination consists of a steering axle and four or more consecutive tandem axles. This is described in [OAR 734-082-0005\(31\)](#).

All permits requesting Weight Table 5 weights must be processed through the Over-Dimension Permit Unit, and are not allowed on the Self-Issue Permits Program.

"Weight Table 5 by Formula"

Per [OAR 734-082-0015 \(4b\)](#), additional weight is allowed for axles that are 10 feet wide and have 8 tires per axle. These are commonly referred to as "Weight Table 5 by Formula" or "Bonus Weight" permits.

All permits requesting Weight Table 5 by Formula weights must be processed through the Over-Dimension Permit Unit, and are not allowed on the Self-Issue Permits Program.

"Weight Table X"

Per [OAR 734-082-0015 \(4c\)](#), additional weight may allowed when axle or group axle weights exceed those allowed in published weight tables. These requests require analysis by the ODOT Bridge Section, and may be permitted on a case-by-case basis. These are commonly referred to as "Weight Table X" or "Bridge Review" permits.

All permits requesting a review by the ODOT Bridge Section must be processed through the Over-Dimension Permit Unit, and are not allowed on the [Self-Issue Permits Program](#).

Trailer Types

Five types of trailers are recognized in Oregon:



Fixed Trailers are not reducible in length.



Stretch Trailers are capable of increasing the distance from the kingpin or coupling device to the rearmost axle. This is accomplished by using a telescoping principle in the trailer. This does not include fixed or sliding extensions to either end of the trailer with removable deck sections.

Expanded Trailers can be extended in length by adding removable deck section(s).

Special Use Trailers are specifically designed to haul one type of commodity only.



Tow-away includes all equipment or tools mounted on wheels designed for towing by a motor vehicle, and which is not designed or used primarily for the transportation of persons or property, but is only incidentally operated or moved upon a highway.



Float Position – The semitrailer is not directly connected to the fifth wheel hitch on the truck tractor. This is typically used to haul long beams or poles, but can be used for other commodities.

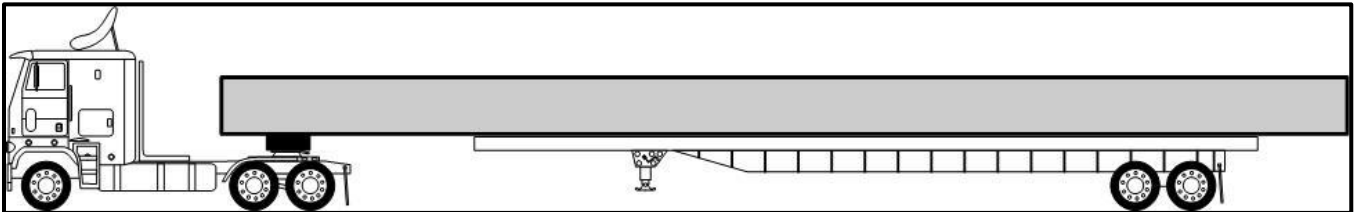

Trailer Extensions

Length of fixed or expanded trailers may be increased by using one or more of the following:

Flip axle(s) - an axle that is bolted or pinned to a vehicle and flips from the closed position on the trailer to a deployed position on the ground extending the length or hauling capacity of the trailer.



Flip neck extension - a gooseneck extension to the front of a trailer which can be flipped up or down, and can be used to adjust the axle weight(s) of a combination and load.



Pinned axle(s) - a separate vehicle pinned to another vehicle adding extra carrying capacity to a vehicle. The additional axle(s) do not pivot from side to side at the connection point or have wheels that steer during turning.

What is Permittable by Self-Issue?

Solo Vehicles

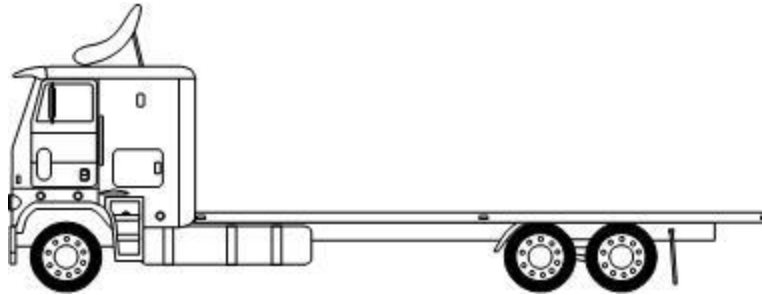

Width	Up to 14 feet 00 inches.
Front Overhang	<p>In excess of 4 feet 00 inches, as long as rear overhang does not exceed 3/4 wheelbase, and subject to maximum allowable overall length. Refer to Attachment 82A for pilot vehicle requirements for front overhang. Vehicles cannot have excessive front and rear overhang at the same time.</p> <p>Front Overhang is measured from the front bumper of the power unit to the front of the load.</p> <p>Vehicles cannot have excessive front and rear overhang at the same time.</p>
Rear Overhang	<p>Up to 100% wheelbase, as long as front overhang does not exceed 4 feet, and subject to maximum allowable overall length. Wheelbase is measured from center of the first axle to the center of the last axle.</p> <p>Rear Overhang is measured from center of last axle to end of load.</p> <p>Vehicles cannot have excessive front and rear overhang at the same time.</p>
Load Length	Up to 50 feet 00 inches . Maximum load length is subject to front or rear overhang as described above.
Overall Length	Up to 50 feet 00 inches . Overall length is subject to the maximum front or rear overhang.
Height	Up to 15 feet 00 inches subject to vertical clearance routing. Load height is measured from the ground (when sitting on a level surface), to the highest point of the load, when loaded and ready for transport.
Weight	Permit Weight Table 1 , 3 , or 4 . When moving a single non-divisible item, heavy haul weights are allowed under the appropriate weight table. If hauling multiple items, weight must be legal under Permit Weight Table 1.
Authorized Commodity	One single, non-divisible item . When operating at legal weight, multiple items may be hauled. Multiple items cannot cause overwidth, overlength, or overheight by loading side by side, overlapping, staggered, end to end, or stacked one on top of the other.
Vehicle Length	A laden or unladen solo vehicle cannot exceed 40 feet in length. No permit is available to exceed this length.

What is Permittable by Self-Issue?

Truck Tractor / Semitrailer

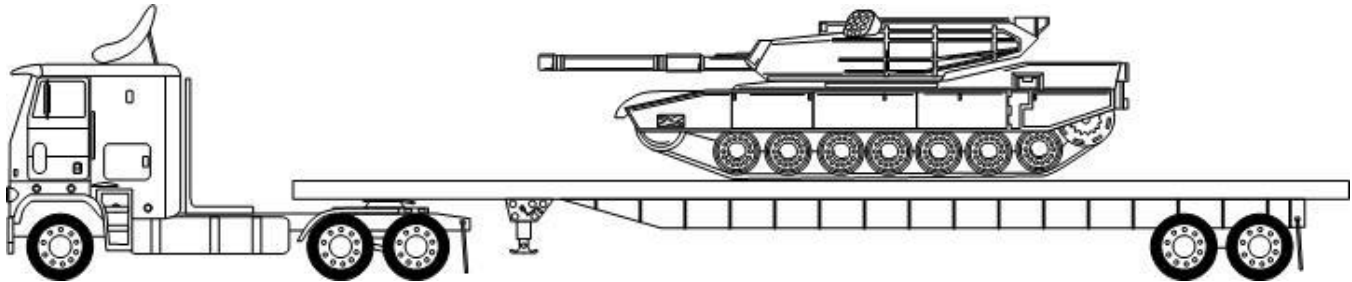

Width	Up to 14 feet 00 inches.
Front Overhang	<p>In excess of 4 feet 00 inches, as long as the rear overhang does not exceed 1/3 wheelbase and the overall length (including overhangs) does not exceed 60'. If overall length exceeds 60' (including overhangs) and front overhang exceeds 4', rear overhang cannot exceed 5' from end of last vehicle on the ground. A load cannot have excessive front and rear overhang at the same time.</p> <p>Front Overhang is measured from the front bumper of the power unit to the front of the load.</p>
Rear Overhang	<p>Up to 1/2 wheelbase. Wheelbase is measured from center of the first axle to the center of the last axle of the combination.</p> <p>Rear overhang is measured from center of last axle of the combination to end of load.</p> <p>When rear overhang exceeds 5 feet from the end of the last vehicle on the ground, front overhang cannot exceed 4 feet, unless the overall length is 60 feet or less (including overhangs) and rear overhang is one third wheelbase. A load cannot have excessive front and rear overhang at the same time.</p>
Load Length	<p>In excess of 40 feet 00 inches. Multiple items (legal weight only) hauled on a semitrailer may exceed 40 feet as long as they do not extend more than 5 feet beyond the end of the semitrailer. When hauling multiple items, the trailer and overall length limits shown on Group Map 1 and Route Map 7 apply.</p>
Trailer Length	<p>Up to 53 feet 00 inches for fixed trailers. Some highways are restricted based on trailer length, and longer trailers are only allowed if necessary to support the load or distribute weight. A front pilot vehicle is required when operating on a length restricted highway, laden and unladen. Refer to Group Map 1 and Route Map 7 for legal lengths allowed.</p> <p>Up to 65 feet 00 inches for fixed trailers if flip axle(s) or a flip neck extension are deployed, or pinned axle(s) are added. The trailer must be reduced to legal length when unladen or an unladen authorization is required on the permit.</p> <p>Up to 65 feet 00 inches for special use trailers, or tow-away trailers.</p> <p>Up to 65 feet 00 inches for stretch trailers. Stretch trailers must be reduced to 53 feet or less when unladen.</p>

	Up to 65 feet 00 inches for expanded trailers. Expanded trailers must be reduced to 53 feet or less when unladen, or a permitted unladen authorization is required.
Overall Length	Up to 95 feet on two-lane highways, up to 105 feet on multilane highways.
Height	Up to 15 feet 00 inches , subject to vertical clearance routing. Load height is measured from the ground (when sitting on a level surface), to the highest point of the load. Show height to the next highest inch. For example, 14 feet 03 inches and 1/2 inch should show as 14 feet 04 inches. Refer to Attachment 82A for pilot vehicle requirements for height.
Weight	Permit Weight Table 1 , 3 , or 4 , not to exceed 200,000 pounds gross weight. When hauling multiple items, the permit can be used in conjunction with a valid extended weight permit issued to the power unit.
Unladen	Operating oversize and/or overweight when unladen requires a permit. A front pilot vehicle is required when operating on a length restricted highway when unladen. Refer to Group Map 1 and Route Map 7 for legal lengths allowed.
Authorized Commodity	Any Single Non-Divisible Item when operating under Weight Tables 3 or 4. Multiple permissible items are allowed when operating under Weight Tables 1, but multiple items cannot cause overwidth, overlength, or overheight by loading side by side, overlapping, staggered, end to end, or stacked one on top of the other.

What is Permittable by Self-Issue?

Tow Vehicle

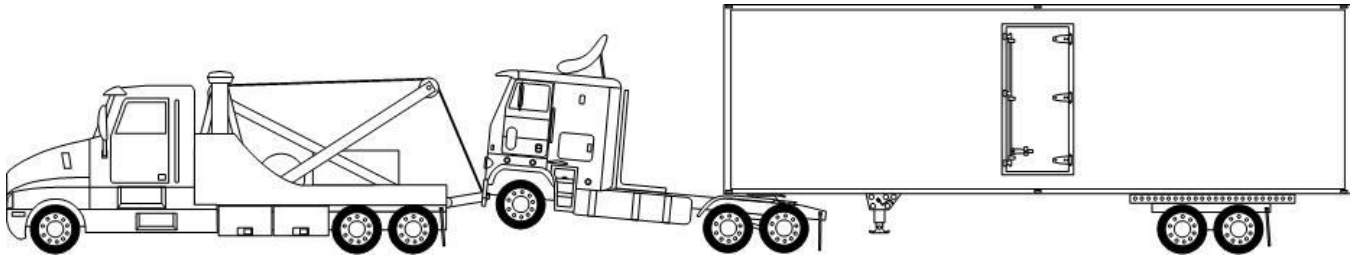

Width	Up to 10 feet 00 inches.
Front Overhang	<p>In excess of 4 feet 00 inches, as long as the rear overhang does not exceed 1/3 wheelbase and the overall length (including overhangs) does not exceed 60'. If overall length exceeds 60' (including overhangs) and front overhang exceeds 4 feet, rear overhang cannot exceed 5' from end of last vehicle on the ground. A load cannot have excessive front and rear overhang at the same time.</p> <p>Front Overhang is measured from the front bumper of the power unit to the front of the load.</p>
Rear Overhang	<p>Up to 1/2 wheelbase. Wheelbase is measured from center of the first axle to the center of the last axle of the combination.</p> <p>Rear overhang is measured from center of last axle of the combination to end of load.</p> <p>When rear overhang exceeds 5 feet from the end of the last vehicle on the ground, front overhang cannot exceed 4 feet, unless the overall length is 60 feet or less (including overhangs) and rear overhang is one third wheelbase. A load cannot have excessive front and rear overhang at the same time.</p>
Load Length	The length of the wrecked or disabled vehicle or combination of vehicles being hauled or towed.
Trailer Length	<p>Up to 53 feet 00 inches for fixed trailers. Some highways are restricted based on trailer length, and longer trailers are only allowed if necessary to support the load or distribute weight. A front pilot vehicle is required when operating on a length restricted highway, laden and unladen. Refer to Group Map 1 and Route Map 7 for legal lengths allowed.</p> <p>Up to 65 feet 00 inches for fixed trailers if flip axle(s) or a flip neck extension are deployed, or pinned axle(s) are added. The trailer must be reduced to legal length when unladen or an unladen authorization is required on the permit.</p> <p>Up to 65 feet 00 inches for special use trailers, or tow-away trailers.</p> <p>Up to 65 feet 00 inches for stretch trailers. Stretch trailers must be reduced to 53 feet or less when unladen.</p> <p>Up to 65 feet 00 inches for expanded trailers. Expanded trailers must be reduced to 53 feet or less when unladen, or a permitted unladen authorization is required.</p>

Overall Length	Up to 120 feet 00 inches.
Height	Up to 14 feet 06 inches , subject to vertical clearance routing. Load height is measured from the ground (when sitting on a level surface), to the highest point of the load. Show height to the next highest inch. For example, 14 feet 03 inches and 1/2 inch should show as 14 feet 04 inches.
Weight	Permit Weight Table 1, 3, or 4 , not to exceed 200,000 pounds gross weight. Additional weight on some groups is allowed, as described in Attachment 76A .
Authorized Commodity	Disabled vehicle or combination of vehicles.

What is Permittable by Self-Issue?

Self-Propelled Fixed Load Vehicle



A self-propelled fixed load vehicle differs from a solo vehicle in that it is oversized and or overweight, operating under its own power. A self-propelled vehicle does not haul a load - it is the load.

Width	Up to 14 feet 00 inches.
Front Overhang	<p>In excess of 4 feet 00 inches, as long as rear overhang does not exceed 3/4 wheelbase, and subject to maximum allowable overall length. Refer to Attachment 82A for pilot vehicle requirements for front overhang. Vehicles cannot have excessive front and rear overhang at the same time.</p> <p>Front Overhang is measured from the front bumper of the power unit to the front of the load.</p> <p>Vehicles cannot have excessive front and rear overhang at the same time.</p>
Rear Overhang	<p>Up to 100% wheelbase, as long as front overhang does not exceed 4 feet, and subject to maximum allowable overall length. Wheelbase is measured from center of the first axle to the center of the last axle.</p> <p>Rear Overhang is measured from center of last axle to end of load.</p> <p>Vehicles cannot have excessive front and rear overhang at the same time.</p>
Load Length	Up to 55 feet 00 inches , including front and/or rear overhang. Load length on a self-propelled fixed load vehicle will always be the same as the overall length.
Overall Length	Up to 55 feet 00 inches , including front and/or rear overhang. Overall length on a self-propelled / fixed load vehicle will always be the same as the load length.
Height	Up to 15 feet 00 inches , subject to vertical clearance routing. Load height is measured from the ground (when sitting on a level surface), to the highest point of the vehicle, when loaded and ready for transport.
Weight	Permit Weight Table 1 , 3 , or 4 , not to exceed 200,000 pounds gross weight.
Authorized Commodity	Self-Propelled Vehicle is the commodity.

A self-propelled fixed load vehicle is not authorized to carry a load, other than the equipment required to do a job. For example, a well drilling rig may have one bit and the pipe required to do a single job. Any additional bits or hammers must be hauled separately.

A self-propelled vehicle may tow a pickup truck or passenger car. A vehicle towed shall not exceed the weights shown on [Weight Table 1](#) and shall not exceed 20 feet in length.

What is Permittable by Self-Issue?

Self-Propelled Fixed Load Vehicle with Booster/Dolly Axle(s)

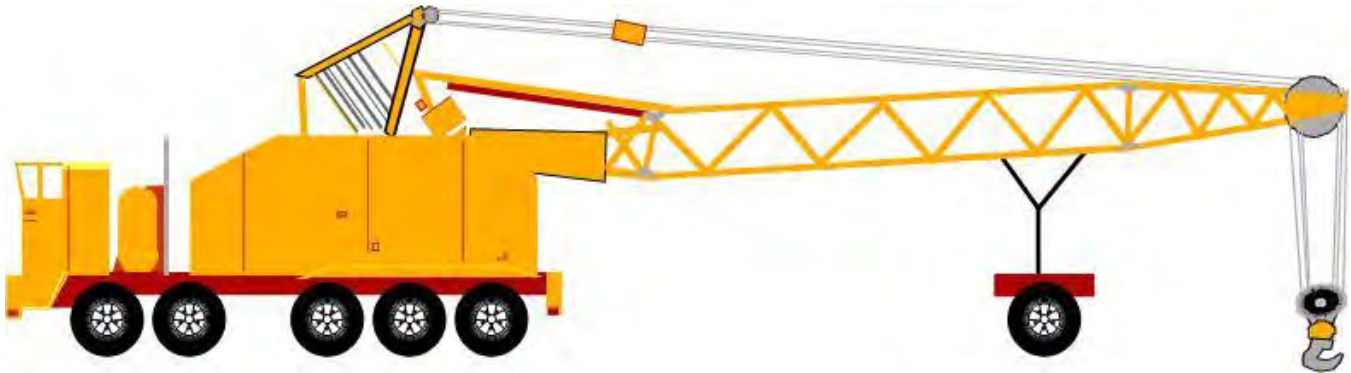

Width	Up to 14 feet 00 inches.
Front Overhang	<p>In excess of 4 feet 00 inches as long as the rear overhang does not exceed 1/3 wheelbase and the overall length (including overhangs) does not exceed 60 feet. If overall length exceeds 60 feet (including overhangs) and front overhang exceeds 4 feet, rear overhang cannot exceed 5 feet from end of last vehicle on the ground. A load cannot have excessive front and rear overhang at the same time.</p> <p>Front Overhang is measured from the front bumper of the power unit to the front of the load.</p>
Rear Overhang	<p>Up to 1/2 wheelbase. Wheelbase is measured from center of the first axle to the center of the last axle of the combination.</p> <p>Rear overhang is measured from center of last axle of the combination to end of load.</p> <p>When rear overhang exceeds 5 feet from the end of the last vehicle on the ground, front overhang cannot exceed 4 feet, unless the overall length is 60 feet or less (including overhangs) and rear overhang is one third wheelbase. A load cannot have excessive front and rear overhang at the same time.</p>
Load Length	Up to 120 feet 00 inches , including front and/or rear overhang. Load length on a self-propelled fixed load vehicle with booster/dolly axle(s) will always be the same as the overall length.
Overall Length	Up to 120 feet 00 inches , including front and/or rear overhang. Overall length on a self-propelled fixed load vehicle with booster/dolly axle(s) will always be the same as the load length.
Height	Up to 15 feet 00 inches , subject to vertical clearance routing. Load height is measured from the ground (when sitting on a level surface), to the highest point of the vehicle, when loaded and ready for transport.
Weight	Permit Weight Table 1 , 3 , or 4 , not to exceed 200,000 pounds gross weight.

Width	Up to 14 feet 00 inches.
Authorized Commodity	Specific to the vehicle(s) on the ground. Some examples include Self-Propelled Vehicle with Booster or Self-Propelled Vehicle with Boom Dolly.

A self-propelled vehicle is not authorized to carry a load, other than the equipment required to do a job. For example, a well drilling rig may have one bit and the pipe required to do a single job. Any additional bits or hammers must be hauled separately.

What is Permittable by Self-Issue?

Mobile / Modular Units

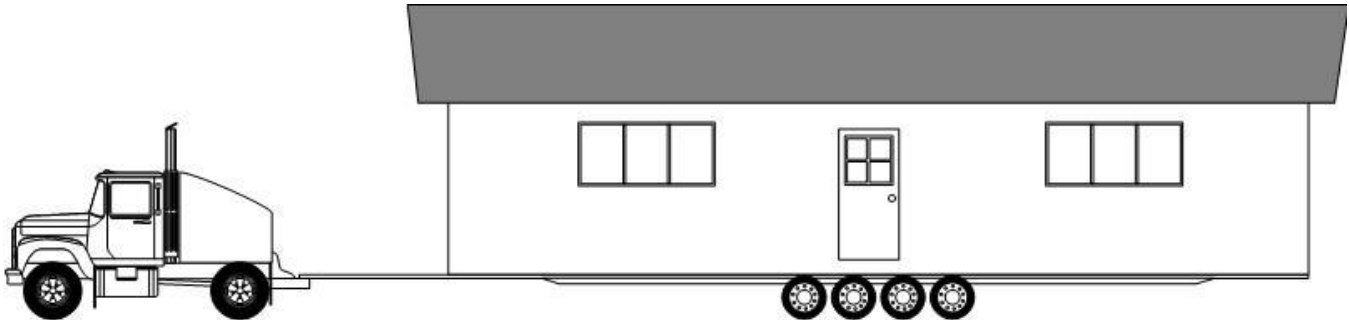

By definition, mobile units are on their own axles, while modular units are hauled on a semitrailer.

Width	Up to 14 feet 00 inches , inclusive of eave(s).
Front Overhang	Legal. Front overhang in excess of 4 feet off the front bumper of the power unit is not allowed for mobile / modular units in the self-issue permits program.
Rear Overhang	Modular units (hauled on a trailer, not on their own axles) can be permitted up to 1/2 wheelbase, subject to overall length limits. Wheelbase is measured from center of the first axle to the center of the last axle of the combination. Rear Overhang is measured from center of last axle of the combination to end of load.
Load Length	75 feet 00 inches. This includes the length of the mobile / modular unit, inclusive of tongue.
Trailer Length	75 feet 00 inches Maximum stretch trailer length when hauling modular units. Trailer must be reduced to 53 feet or less in length when unladen.
Overall Length	95 feet 00 inches on Group 1 Highways on Route Map 1 . Up to 110 feet 00 inches on Interstate and multilane highways, including front and / or rear overhang.
Height	Up to 15 feet 00 inches , subject to vertical clearance routing. Load height is measured from the ground (when sitting on a level surface), to the highest point of the load, when loaded and ready for transport.
Weight	Permit Weight Table 1 for mobile units (on their own axles), or Weight Table 1, 2, or 3 for modular units (hauled on a trailer). When operating with Weight Table 3 weights, only those items that are manufactured as part of, and are attached to the unit are authorized. Ship loose material loaded inside the unit is not authorized.
Authorized Commodity	Mobile Unit or Modular Unit is the commodity.

What is Permittable by Self-Issue?

Truck Tractor / Semitrailer Overlength

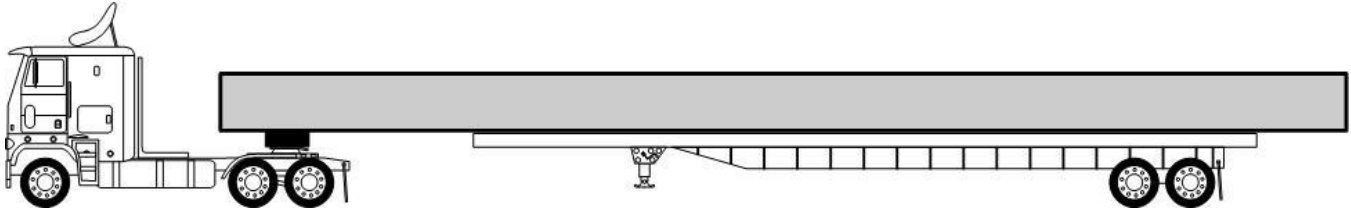

Width	Up to 8 feet 06 inches.
Front Overhang	<p>In excess of 4 feet 00 inches, as long as the rear overhang does not exceed 1/3 wheelbase and the overall length (including overhangs) does not exceed 60'. If overall length exceeds 60' (including overhangs) and front overhang exceeds 4', rear overhang cannot exceed 5' from end of last vehicle on the ground. A load cannot have excessive front and rear overhang at the same time.</p> <p>Front Overhang is measured from the front bumper of the power unit to the front of the load.</p>
Rear Overhang	<p>Up to 1/2 wheelbase. Wheelbase is measured from center of the first axle to the center of the last axle of the combination.</p> <p>Rear overhang is measured from center of last axle of the combination to end of load.</p> <p>When rear overhang exceeds 5 feet from the end of the last vehicle on the ground, front overhang cannot exceed 4 feet, unless the overall length is 60 feet or less (including overhangs) and rear overhang is one third wheelbase. A load cannot have excessive front and rear overhang at the same time.</p>
Load Length	In excess of 40 feet 00 inches.
Trailer Length	<p>Up to 53 feet 00 inches for fixed trailers. Some highways are restricted based on trailer length, and longer trailers are only allowed if necessary to support the load or distribute weight. A front pilot vehicle is required when operating on a length restricted highway, laden and unladen. Refer to Group Map 1 and Route Map 7 for legal lengths allowed.</p> <p>Up to 65 feet 00 inches for fixed trailers if flip axle(s) or a flip neck extension are deployed, or pinned axle(s) are added. The trailer must be reduced to legal length when unladen or an unladen authorization is required on the permit.</p> <p>Up to 65 feet 00 inches for special use trailers, or tow-away trailers.</p> <p>Up to 65 feet 00 inches for stretch trailers. Stretch trailers must be reduced to 53 feet or less when unladen.</p> <p>Up to 65 feet 00 inches for expanded trailers. Expanded trailers must be reduced to 53 feet or less when unladen, or a permitted unladen authorization is required.</p>
Overall Length	Up to 140 feet 00 inches.

Height	Up to 14 feet 00 inches , subject to vertical clearance routing.
Weight	Permit Weight Table 1 . The permit may be used in conjunction with a valid extended weight permit, issued to the power unit.
Unladen	Operating oversize and/or overweight when unladen requires a permit. A front pilot vehicle is required when operating on a length restricted highway when unladen. Refer to Group Map 1 and Route Map 7 for legal lengths allowed.
Authorized Commodity	Beams or Rebar is an example commodity.

What is Permittable by Self-Issue?

Heavy Haul Combination of Vehicles

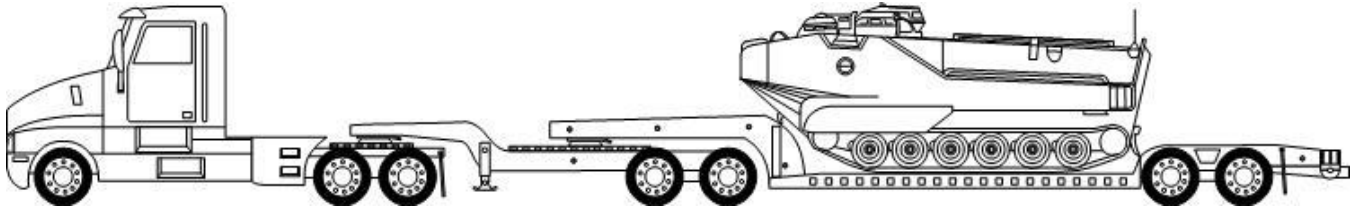

A combination of vehicles may consist of truck tractor, semitrailer, jeeps, boosters, dollies, mechanical / manual steer car or trailer. Tow-away fixed load vehicles are treated the same as a semitrailer for size and weight purposes.

Width	Up to 14 feet 00 inches.
Front Overhang	<p>In excess of 4 feet 00 inches. A load cannot have excessive front and rear overhang at the same time.</p> <p>Include language in special provisions “Load allowed to extend forward of the rear of the cab of the truck” when the load a load on the semitrailer extends forward of the rear of the cab of the truck.</p>
Rear Overhang	<p>Up to 1/2 wheelbase. Wheelbase is measured from center of the first axle to the center of the last axle of the combination.</p> <p>Rear overhang is measured from center of last axle of the combination to end of load.</p> <p>A load cannot have excessive front and rear overhang as the same time.</p>
Load Length	In excess of 40 feet 00 inches.
Trailer Length	<p>Up to 62 feet 00 inches for fixed trailers.</p> <p>Up to 65 feet 00 inches for fixed trailers if flip axle(s) are deployed, a flip neck extension is deployed, or pinned axle(s) are added.</p> <p>Up to 65 feet 00 inches for stretch, expanded, special use, or tow-away trailers.</p>
Overall Length	Up to 120 feet 00 inches.
Height	Up to 15 feet 00 inches , subject to vertical clearance routing. Load height is measured from the ground (when sitting on a level surface), to the highest point of the load.
Weight	Permit Weight Table 1 , 3 , or 4 , not to exceed 200,000 pounds gross weight.
Unladen	Operating oversize and/or overweight when unladen requires a permit. An unladen combination of vehicles used to transport non-divisible loads may consist of the power unit and not more than one jeep, one semitrailer, and one booster, provided the semitrailer length is not more than 65 feet and the overall length is not more than 120 feet.

	<p>Movement is authorized unladen with fewer vehicles, or with a jeep and/or booster loaded on the semitrailer. If the unladen combination is operating in excess of legal axle weights (Weight Tables 1 and 2), both the jeep and booster CANNOT be loaded on the semitrailer at the same time. Only one can be hauled and the other must be on the ground. When unladen operating with heavy haul weights (Weight Tables 3 or 4), all axles must be deployed. An annual unladen heavy haul combination permit is available.</p> <p>A separate single trip permit is required when unladen and exceeding 98,000 pounds gross weight. Payment of road use assessment fees (RUAF) is required when operating under these permits.</p>
Authorized Commodity	Any single, non-divisible item when operating under Weight Table 3 or 4.

Routing – Road Restrictions

Is the requested route near any short term restrictions? SIPP permit writers are required to check the Restriction List to verify the route will accommodate the load, prior to moving.

- Any restrictions that may impact the move must be included in the Special Provisions of the permit.
- Only those restrictions that impact the move must be included in the Special Provisions of the permit.
- Loads up to 12 feet wide can travel on Interstate highways during hours of darkness, so those restrictions must be included.

The Restriction List can be found at:

<https://www.oregontruckingonline.com/cf/MCAD/pubMetaEntry/restrictionsList/>

Also, motor carriers can sign up to receive email notification of restrictions that impact annual restrictions: <https://www.oregon.gov/ODOT/MCT/Pages/GovDeliveryMotorCarrier.aspx>. This is a free service, eliminating unnecessary paper documents. Motor carriers choose the information they are interested in receiving. In addition to the restriction letters, ODOT offers subscribers more than 250 specialized email alerts for information like trucking advisories, Oregon Motor Carrier Newsletter, Motor Carrier rulemaking, Commerce and Compliance Advisory Committee Meeting Notices/Minutes, etc.



Routing – Weight Restrictions

If the load is a single, non-divisible item, do all axle and group axle weights fit [Weight Table 3](#) or [4](#)? Is the gross weight less than 200,000 pounds? Access the online weight analysis calculator at <https://www.oregontruckingonline.com>.

Is the requested route near any weight restricted bridges? See [Route Map 8](#) for long term weight restrictions, including possible traffic control options to cross the structure safely, or consult the Restriction List at <https://www.oregontruckingonline.com>.

Yaquina Bay Bridge – US101 MP 141.67 near Newport



This bridge is restricted to 98,000 pounds gross weight, Weight Table 3 axle and group axle weights. Loads exceeding these weight limits can cross the bridge if they stop traffic, straddle the centerline, and are on the only vehicle on the bridge when crossing. Certified flaggers are required to stop northbound and southbound traffic while crossing.

Example

From: Lincoln City (Junction of US101 and OR18)

To: Waldport (Junction of US101 and OR34)

Via: US101, stop traffic, straddle centerline, be the only vehicle on bridge when crossing Yaquina Bay Bridge at MP 141.67.

Also, in the Special Provisions section of the self-issue application, check the box that certified flaggers and signing are required. Do NOT check the box that the certified rolling stop is allowed at this location.

Reinhart Creek Bridge – US101 MP 311.40 south of Port Orford



This bridge is restricted to 98,000 pounds gross weight, Weight Table 3 axle and group axle weights. Loads exceeding these weight limits can cross the bridge if they stop traffic and straddle the centerline when crossing. Certified flaggers are required to stop oncoming traffic while crossing.

Example

From: Coos Bay (Junction of US101 and OR42)

To: OR/CA Border at US101

Via: US101, stop oncoming traffic and straddle centerline when crossing Reinhart Creek Bridge at MP 311.40.

Also, in the Special Provisions section of the self-issue application, check the box that certified flaggers and signing are required. Do NOT check the box that the certified rolling stop is allowed at this location.

Santiam River Bridge – OR164 MP 8.64 in Jefferson



This bridge is restricted to 98,000 pounds gross weight, Weight Table 3 axle and group axle weights. Loads exceeding these weight limits and needing to use I-5 Exit 244 or Exit 238, depending on which side of the bridge is accessed.

Routing – Length

If the combination is a truck tractor/semitrailer, is the route on any length restricted highways? Is the trailer 53 feet or less in length? See [Route Map 7](#) and [Group Map 1](#) for legal lengths.

Pickup or delivery of an oversize load is allowed on length-restricted highways, but must be routed the shortest distance on the length restricted highway, even if that requires a significant detour.

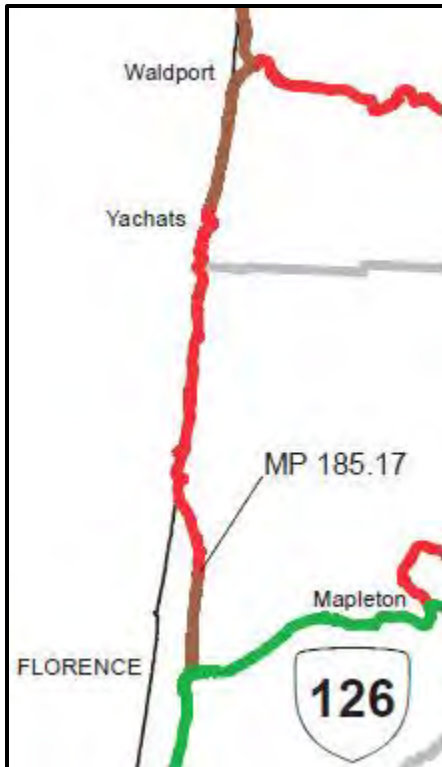

For example: US101 is a red route on Route Map 7, from the town of Yachats to MP 185.17, a few miles north of Florence. This section of US101 can be used for pickup or delivery of an oversize load, but can NOT be used as a through route. Permits must be routed the shortest distance on the red designated section of US101, even if that means detouring to I-5.

If using a stretch or expanded semitrailer in a heavy haul combination, is it 65 feet or less in length? Can the trailer be reduced to 53 feet or less in length when unladen? Is the trailer length required to reduce the height of the load, support the load, or accommodate the weight of the load?

If using a trailer longer than 53 feet in length in a truck-tractor / semitrailer combination, is the trailer 65 feet or less in length? Can the trailer be reduced to 53 feet or less in length when unladen? Is the trailer length required to reduce the height of the load, support the load, or accommodate the weight of the load?

For all permits, is the trailer length and overall length within the guidelines of the self-issue permits program?

Overlength cannot be caused by loading side by side, overlapping, staggered, end to end, or stacked one on top of the other.

Overlength loads may require pilot vehicles. See [Route Map 2](#), and [Attachment 82A](#) or [Attachment 75A](#) for requirements.

Make sure to note any front or rear overhang on the permit, and include that in the overall length.

Routing – Width

If width is greater than 8 feet 06 inches, is that caused by a single, non-divisible item? Can this item be easily reduced or loaded differently to a lesser width?

Overwidth cannot be caused by loading side by side, overlapping, staggered, end to end, or stacked one on top of the other.

Pickup or delivery of load in excess of 12 feet wide is allowed on red routes on [Route Map 9](#) (or [Route Map 6](#)), but must be routed the shortest distance on the red route, even if that requires a significant detour.

Overwidth loads may require pilot vehicles. See [Route Map 2](#), [Group Map 1](#), and Attachment 82A or 75A for requirements.



Routing – Height

If height is greater than 14 feet, is this caused by a single, non-divisible item? Can this item be easily reduced or loaded differently to a lower height? Overheight cannot be caused by loading side by side, overlapping, staggered, end to end, or stacked one on top of the other. Item(s) loaded on the top deck of a drop deck trailer cannot be higher than an item loaded on the lower deck.

Check with Appendix A (Height Restrictions) before routing overheight loads. Another reference up to 14 feet 06 inches high on major state maintained roads is [Route Map 3](#).

A front pilot vehicle with a height pole is required for heights greater than 14 feet 06 inches, unless the carrier has filed a declaration with CCD assuming complete and total liability for any and all injury and damage that may result from the overheight movement.



Routing – Non-ODOT Jurisdiction Roads

Not all roads in Oregon are maintained by the Oregon Department of Transportation. It is the carrier's responsibility to obtain approval from the appropriate road authorities (i.e. cities, counties) prior to making the move. If approval is obtained, and the route is listed on the self-issue permit, include the name of the city/county, the approving person, and the fees associated with that approval, if any.



Check route maps to see if a road is maintained by ODOT. Other roads not authorized for use on self-issue permits include US Forest Service roads, Bureau of Land Management roads, public access roads, and private roads.

Specific routing must be included on the permit, and travel must be made in the sequence shown on the permit. Use of Exit numbers where available is required, except when exiting from one Interstate highway to another Interstate highway.

When exiting the state system onto another road (i.e. City, County, Forest Service), the exact location must be identified in the route.

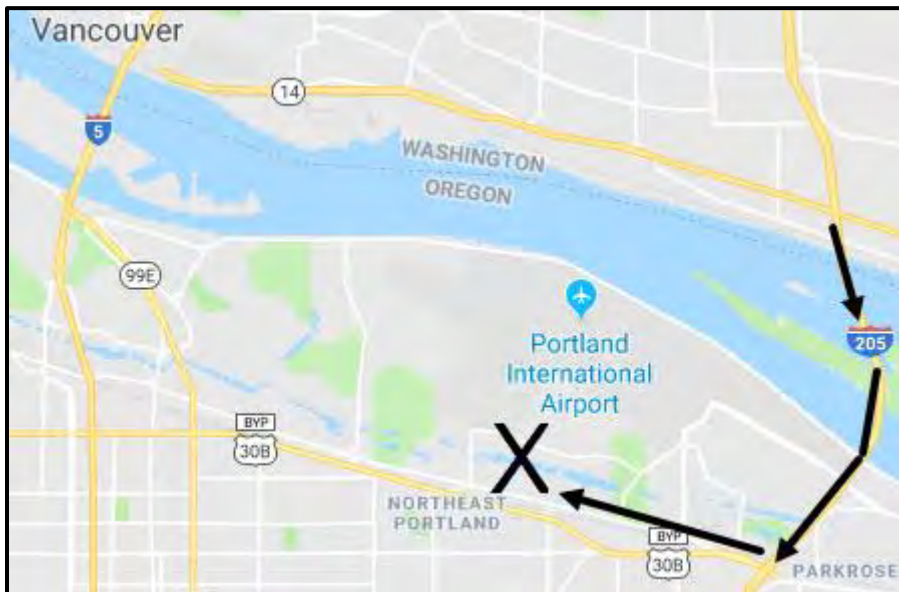

Example 1: from OR/WA Border at I-205 to 613 NE Columbia Blvd in Portland.

From: OR/WA Border at I-205

To: Portland (613 NE Columbia Blvd)

Via: I-205, take Exit 23B to US30 Bypass; exit to city streets (Columbia).

Example 2: from OR/WA Border at I-205 to 613 NE Columbia Blvd in Portland.

From: OR/WA Border at I-205

To: Portland (Junction of US30 Bypass and Columbia Blvd)

Via: I-205, take Exit 23B to US30 Bypass.

In Examples 1 and 2, either routing is acceptable, as we know exactly where the permit ends. The carrier is responsible to obtain an appropriate permit from the City of Portland for use of their roads (Columbia Blvd), as city streets are not authorized on any single-trip permit.

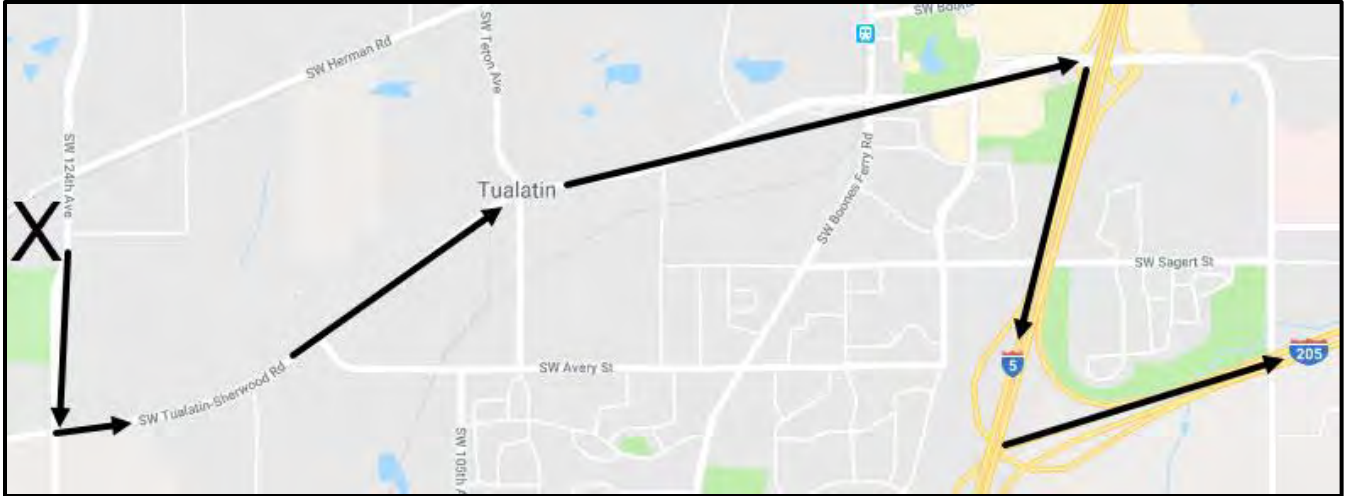

Example 3: from 19855 SW 124th Ave in Tualatin to OR/WA Border at I-205.

From: Tualatin (19855 SW 124th Ave)

To: OR/WA Border at I-205

Via: 124th Ave; Tualatin-Sherwood Rd; Nyberg St; I-5; I-205.

In this example, we expect to see an approval from Washington County, as they have jurisdiction over Tualatin-Sherwood Rd and Nyberg St. 124th Ave is maintained by the City of Tualatin.

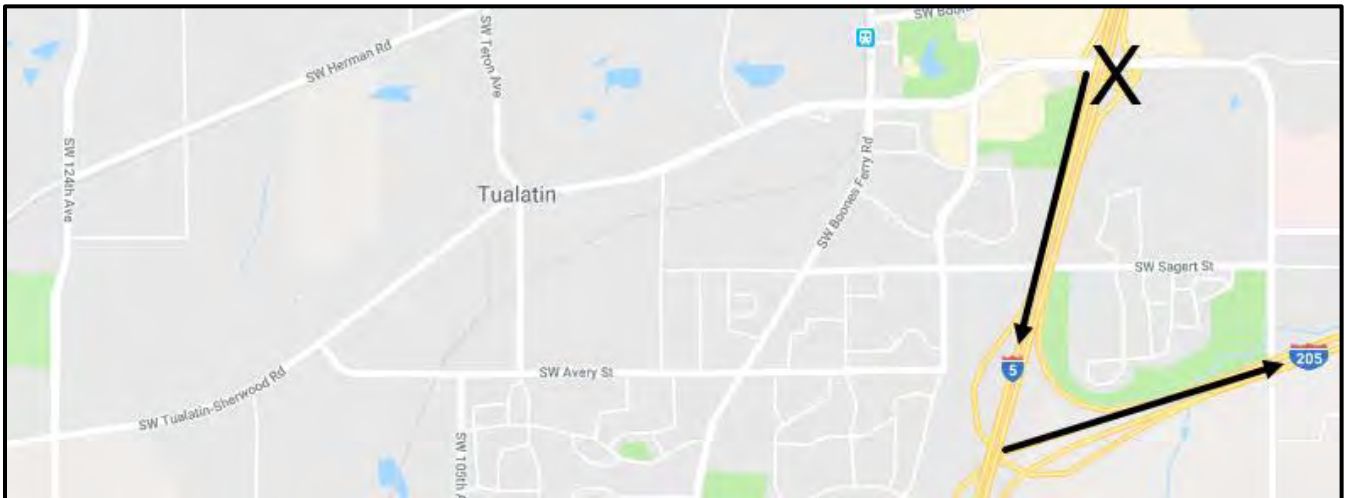

Example 4: from Tualatin (I-5 Exit 289) to OR/WA Border at I-205.

From: Tualatin (I-5 Exit 289)

To: OR/WA Border at I-205

Via: I-5; I-205.

In this example, the routing is acceptable, as the only permitted routes are state highways. The carrier is responsible to obtain an appropriate permit from other authorities for use of roads to get to I-5.

Routing – Straddle Centerline

When required to stop traffic and straddle centerline to safely cross a structure due to width and/or height, this must be included in the route.

Example: A 13 feet wide load moving from Eugene to Klamath Falls will cross through the Salt Creek Tunnel on OR58. Specific routing would include:

I-5, take exit 188 to OR58 * (stop traffic and straddle center line through Salt Creek Tunnel at MP56.01); US97.

In the application, make sure to check the box for the Certified Flagger or Rolling Stop special provision.

Refer to Appendix C for vertical clearance information.



Routing – State Routes with Additional Restrictions

The following routes are allowed in the Self-Issue Permits Program, but have limited dimensions. Permits to exceed these dimensions in either direction of travel must be issued by CCD staff.

- US101 (Oregon Coast Hwy) between Tillamook and OR18.
- OR34 (Asea Hwy) MP 47.70 to MP 52.37, between Asea and Philomath.
- OR140 (Lake of the Woods Hwy) MP 51.74 to MP 58.83 (west of Klamath Falls).
- OR370 (O’Neil Hwy) MP 0.00 to MP 4.97 (US97 to Lone Pine Rd.).

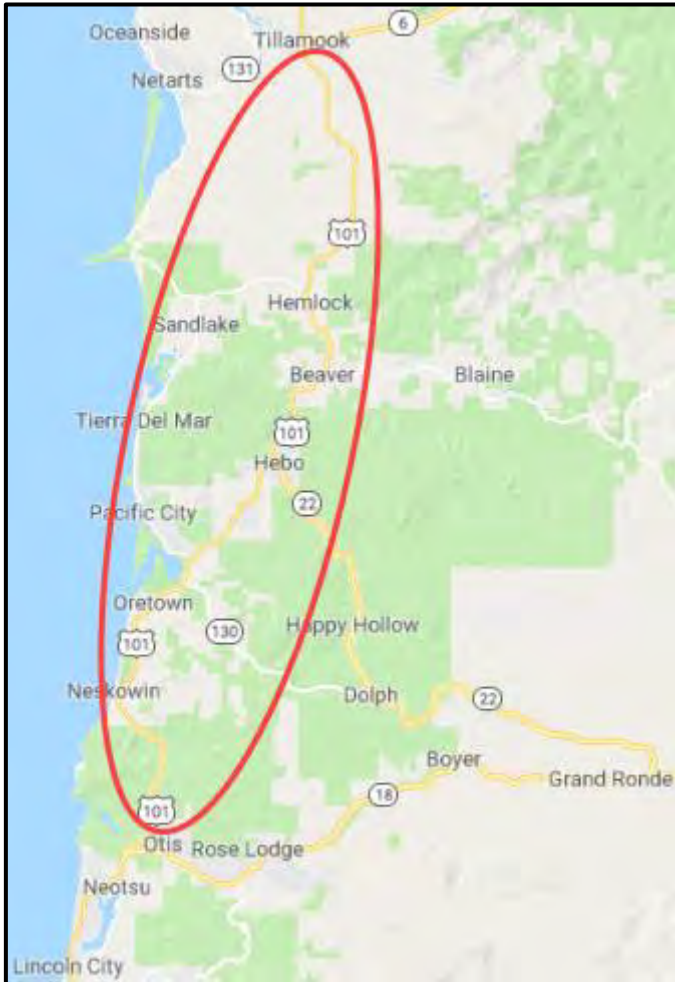

US101 (Oregon Coast Hwy) between Tillamook and OR18

On US101 between Tillamook and OR18, all trailers or semitrailers exceeding 48 feet in length require a permit to be issued by CCD staff, regardless of combination type.

OR34 (Alega Hwy) MP 47.70 to MP 52.37, between Alesa and Philomath

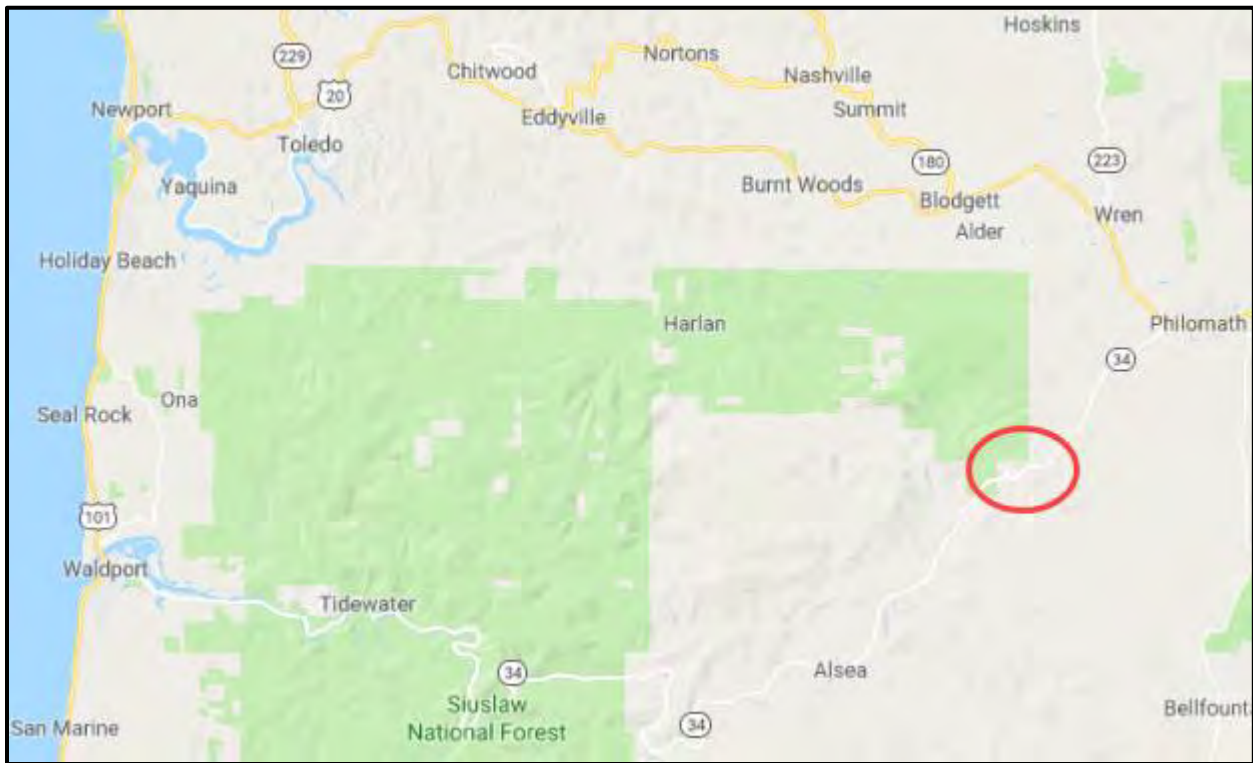

On OR34 (Alega Hwy) between MP 47.70 and MP 52.37, all vehicles or loads over 12 feet wide, and/or over 75 feet overall length require a permit to be issued by CCD staff.

OR140 (Lake of the Woods Hwy) MP 51.74 to MP 58.83 (west of Klamath Falls)



On OR140 (Lake of the Woods Hwy) between MP 51.74 and MP 58.83, all vehicles or loads over 12 feet wide, and/or over 105 feet overall length require a permit to be issued by CCD staff.

OR370 (O'Neil Hwy) MP 0.00 to MP 4.97 (US97 to Lone Pine Rd)



On OR370 (O'Neil Hwy) between US97 and Lone Pine Rd, all vehicles or loads over 12 feet wide, and/or over 60 feet overall length require a permit to be issued by CCD staff.

Routing – Direction of Travel

Direction of travel is NOT required, but if added, must be accurate.

The exception for this is when using I-405, not as a through route. In those cases, travel direction on I-405 (north or south) is required.

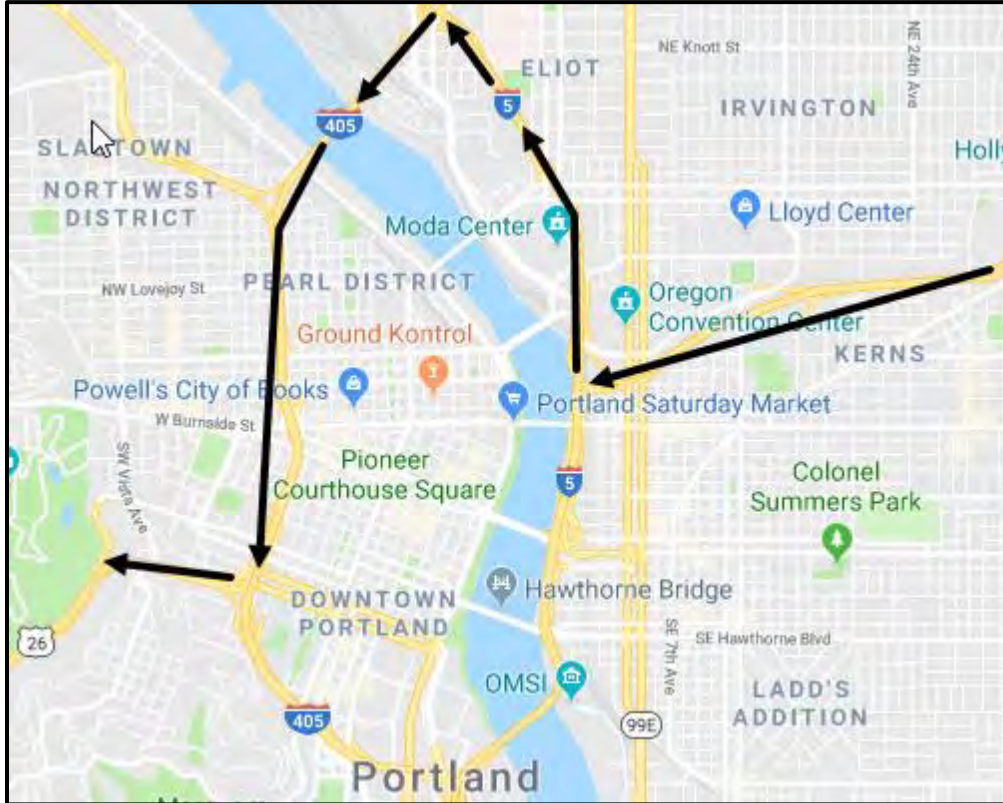

Example 1: I-84; I-5; I-405 south, take Exit 1D to US26.

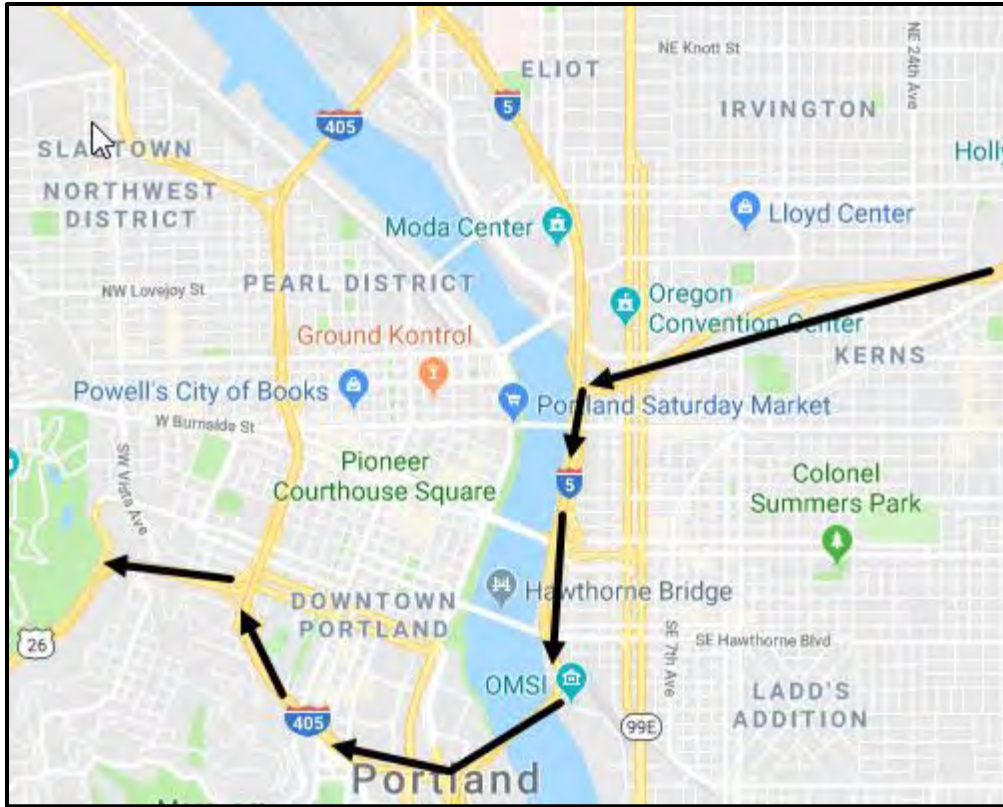

Example 2: I-84; I-5; I-405 north, take Exit 1D to US26.

Routing – Other Considerations

Notes about other ODOT jurisdiction roads

- On- and off-ramps to/from interstates and other major highways are normally maintained by ODOT. These ramps may have weight restrictions, closures, and other routing issues to be considered.
- Overpasses over state maintained roads are normally maintained by ODOT. These bridges may have weight restrictions, closures, and other routing issues to be considered.
- Frontage roads are relatively long stretches of highway that parallel a major state highway, and are often maintained by ODOT. These roads may have weight restrictions, temporary closures, and other routing issues to be considered. Check with the Over-Dimension Permit Unit with any questions about frontage roads.
- Some state highways may not (yet) have route numbers associated with them, or even be signed as state maintained. Check with the Over-Dimension Permit Unit with any questions about highway signing.

Unladen Authorization

Unladen authorization on a single-trip permit is required in the following two situations:

- A truck tractor/semitrailer combination exceeds the lengths allowed (trailer and/or overall) on a length-restricted highway. The length of the trailer is required to support the load or distribute the weight of a single, non-divisible item.
- A heavy haul combination exceeds the dimensions or routes allowed on the annual Unladen Heavy Haul Combination Permit (or the truck does not have a valid unladen heavy haul permit).

If the gross weight exceeds 98,000 pounds, a separate single-trip permit is required. In addition, a front pilot vehicle is required when operating on length restricted highways.

Detour Routes

Detour routes (due to weather conditions or accidents) are not authorized on self-issue permits. A separate permit must be written to authorize use of a detour, and all routing issues must be considered on detour routes.

Specific Starting and Ending Locations:

Starting and Ending Location must be specific. In addition to a general geographic location, a specific address, cross street, or milepost is required.

Acceptable	Unacceptable
Portland (613 NE Columbia Blvd)	Portland
Dayville (Junction of US26 and OR19)	Dayville
Cave Junction (MP32 on US199)	West of Cave Junction

Border Locations

Border locations must adhere to the following format examples:

Acceptable	Unacceptable
OR/ID Border at I-84	Idaho line on I-84
OR/WA Border at US101	Washington line on US101
OR/CA Border at OR39	California line on OR39

There are a few bridges that are in Oregon geographically, but are maintained by another road authority. It is the carrier's responsibility to contact the appropriate road authority for permission to cross these bridges.

Border Location	Format on Permit	Jurisdiction
Washington line near Rainier	OR/WA Border at US30 (Rainier)	Washington DOT 360-704-3640
Washington line near Biggs	OR/WA Border at US97 (Biggs Junction)	Washington DOT 360-704-3640
Washington line near Cascade Locks (Bridge of the Gods)	OR/WA Border at US30 (Cascade Locks)	Port of Cascade Locks 541-374-8619
Washington line near Hood River (White Salmon Bridge)	OR/WA Border at US30/OR35 (Hood River)	Port of Hood River 541-386-1645

Special Provision required if using Bridge of the Gods or the White Salmon Bridge

Bridge of the Gods

Permit does not authorize the use of the Bridge of the Gods. Contact Port of Cascade Locks at 541-374-8619 for authorization.

White Salmon Bridge

Permit does not authorize the use of the White Salmon Bridge. Contact Port of Hood River at 541-386-1645 for authorization.

Formatting

Interstate Highways must have a dash between the "I" and the route number.

- Example: I-5.

US and OR route must be designated as such, with no space between "US" or "OR" and the route number.

- **Examples:** US26; OR217.

Specific routes must be separated by semicolons or commas.

- **Example:** I-5, take Exit 292A to OR217; US26.

Emergency Situations

In an emergency situation, such as a fire, flood, or other immediate threat to life and/or property, contact the Salem Over-Dimension Permit office during normal business hours at 503-373-0000, and identify your permit request as an emergency.

During non-business hours, the emergency number to call is 503-931-1541. Emergency permits issued during non-business hours must be coordinated with Oregon State Police, Motor Carrier Enforcement, and authorized by permit staff. Do not use this number to order a non-emergency permit or inquire about the status of a permit.

How to Add Pilot Vehicles

Pilot vehicle(s) may be required, to alert the traveling public to an oversize load. Equipment requirements and other responsibilities of pilot vehicles can be found in either [Attachment 82A](#) or [75A](#). In Oregon, pilot vehicle operators do NOT have to be certified. When traffic needs to be stopped, certified flaggers and signing are required.

Pilot vehicle(s) are typically required for width and overall length. Uncommonly, a pilot vehicle may be required for excessive front or rear overhang.

A front pilot vehicle is required if the height exceeds 14 feet 06 inches, if the carrier has not filed a height declaration, assuming complete and total liability for any and all injury and damage that may result from the overheight movement.

Within the SIPP application, the carrier is required to identify the placement of pilot vehicle(s), if any, at permitted route and dimensions. Check the "worst case scenario" (where the most pilot vehicles are required, then provide details in the Pilot Vehicles Requirements text.

Example 1: An 11 foot wide load, 75 feet overall length, traveling from Estacada to Eugene.

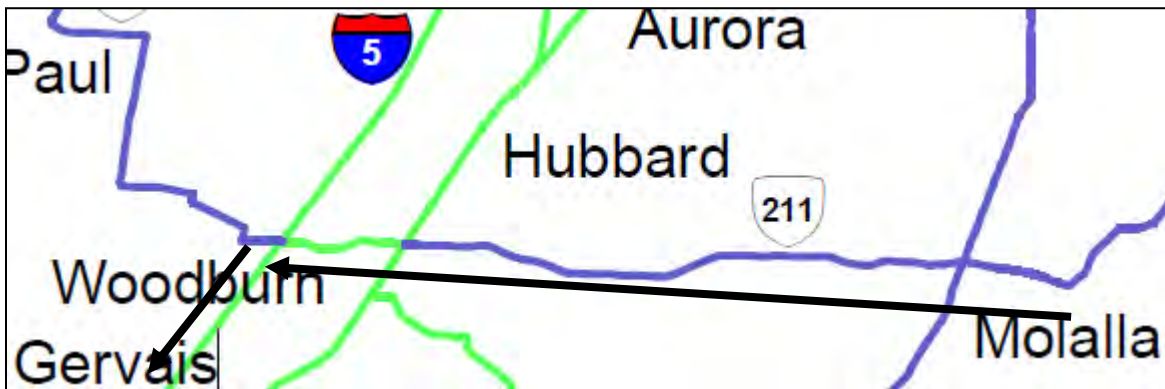

The route is OR211; OR214; I-5.

OR211 is a purple route on [Route Map 2](#). According to the pilot vehicle chart on Attachment 82A, a front pilot vehicle is required at this width on this highway.

OR214 and I-5 are green routes on Route Map 2. According to the pilot vehicle chart on Attachment 82A, no pilot vehicles are required at this width on those highways.

Suggested text for Pilot Vehicle Requirements:

- One front pilot vehicle required on OR211 only.

Example 2: A 13 foot wide load, 75 feet overall length, traveling from Estacada to Eugene.

The route is OR211; OR214; I-5.

OR211 is a purple route on [Route Map 2](#). According to the pilot vehicle chart on [Attachment 82A](#), front and rear pilot vehicles are required at this width on this highway.

OR214 is a green route on Route Map 2. According to the pilot vehicle chart on Attachment 82A, a front pilot vehicle is required on two-lane sections of this highway at this width.

I-5 is a green route on Route Map 2. By definition, this is a multilane highway, and no pilot vehicles are required at this width.

Suggested text for Pilot Vehicle Requirements:

- 1 front and 1 rear pilot vehicles required on OR211 only.
- 1 front pilot vehicle required on other two-lane state highways.

Remember that pilot vehicle(s) may be required for overall length, height, and excessive front overhang. Refer to the charts on [Attachment 82A](#) (or [Attachment 75A](#)).

How to Add Road Restrictions

The Restriction List has details of length, width, height, and weight restrictions, as well as highway and ramp closures, across the entire state. All restrictions that may impact the move must be included on the permit. Only those restrictions that may impact the move are to be included on the permit. The full restriction list is available within the SIPP application, and is available on our website at <https://www.oregontruckingonline.com/cf/MCAD/pubMetaEntry/restrictionsList/>

A few considerations when reviewing the Restriction List:

- Paving work may encroach into daytime hours, so those restrictions must be included.
- Any restrictions that are active when the permit is effective must be included.
- Check for ramp closures.

Restriction List Filters

Filters can be applied to the restriction list to limit the number of road restrictions that are displayed. This may help in determining which restrictions need to be added to the permit.

Day/Night

- Choose “Any Time” if the load you are routing could run during daylight hours (1/2 hour before sunrise to 1/2 hour after sunset) and hours of darkness (1/2 hour after sunset to 1/2 hour before sunrise) hours. This is the default.
- Choose “Day” if the load you are routing could only run during daylight hours (1/2 hour before sunrise to 1/2 hour after sunset).
- Choose “Night” if the load you are routing could only run during hours of darkness (1/2 hour after sunset to 1/2 hour before sunrise).
- Keep in mind that some overwidth loads can travel during hours of darkness, depending on the highways traveled. Refer to [Attachment H](#) for additional information.

Width

- If you wish to filter for width restriction(s), key the maximum width of the load or vehicle being permitted. The default value of 0 feet 00 inches is a special set of numbers for programming purposes, indicating no filtering for a width restriction.
- For example, if you are routing an 11 foot 00 inch wide load and want to filter for width restrictions, key 11 feet 00 inches. Width restrictions up to 11 feet 00 inches will not display, while width restrictions of 11 feet 01 inches and higher will display.

Overall Length

- If you wish to filter for an overall length restriction(s), key the overall length of the vehicle or combination. The default value of 0 feet is a special set of numbers for programming purposes, indicating no filtering for overall length restrictions.
- For example, if you are routing a combination with an overall length of 119 feet, and want to filter for overall length restrictions, key 119 feet. Overall length restrictions up to 119 feet will not display, while overall length restrictions of 120 feet and higher will display.
- The intent of this filter is not for trailer length, or length restrictions for legal combinations as shown on CCD route maps.

Ramp/Mainline

- Choose “Ramp or Mainline” if you want to filter for both mainline and ramp restrictions. This is the default.
- Choose “Ramp only” to only display ramp restrictions.
- Choose “Mainline only” to only display mainline restrictions. When chosen, ramp closures from one state maintained highway to another state maintained highway will also be displayed. Example: the ramp from I-5 northbound to I-205 northbound, since the ramp cannot be used without using a mainline highway anyway.

Effective Date

- Choose “No Filter” if you do not want to filter for the effective date. This is the default.
- Choose “Effective Date” if you want to filter for the effective date. This must be used with other filters.
- If you choose to filter by effective date, the default value for the “Before” date is 14 days from today, normally the last day a single-trip permit could be valid for. You can choose any day. For example, if you choose June 30, 2015, a restriction that begins on July 1, 2015 will NOT be displayed.

General Permit Provisions

Pilot Vehicles

Pilot vehicle(s) may be required to ensure safe movement of overwidth and/or overlength loads and combinations. Certification is NOT required to be a pilot car operator in Oregon. Specific requirements for pilot cars (for example: flares, flashing lights) can be found in [Attachment 82A](#) or [75A](#).



Certified Flagger Locations

Depending upon width and height, certified flaggers may be required to safely cross through bridges or tunnels, or otherwise ensure safe movement of the load or vehicle. The [Certified Flagger Attachment](#) is required whenever certified flaggers are required.

Certified Rolling Stop Location

Depending upon width and height, a certified rolling stop may be required to safely cross through bridges or tunnels, or otherwise ensure safe movement of the load or vehicle. The 18 locations where the certified rolling stop method is allowed can be found on [Route Map 2](#). The certified rolling stop method requires three pilot vehicles.

Hours of Travel

Movement of overwidth loads may be restricted to certain hours, based on road in use, time of day, holiday weekends, and proximity to metropolitan areas. Specific restricted hours of travel can be found in [Attachment H](#).

Warning Lights

Warning lights may be required to ensure safe movement of overwidth loads and combinations. Specific requirements for warning lights can be found in Attachment 82A or 75A.

Warning Signs

OVERSIZE LOAD or WIDE LOAD signs are required to be displayed to the front and rear of any load over 8 feet 06 inches wide, or vehicle or combination of vehicles over 80 feet in overall length. These signs must be reflectorized if traveling during hours of darkness. Specific requirements for warning signs can be found in [Attachment 82A](#) or [75A](#).



Flags

The outermost extremities of an overwidth load or vehicle must be marked with red or orange flags during daylight hours. Flags (or lights, during hours of darkness) are required if a load hangs off the back of the trailer more than 4 feet. Specific requirements for flags can be found in Attachment 82A or 75A.

List of Attachments and Maps

List of attachments that may be required for SIPP permits

- [82A](#) – Required for all single-trip permits except for mobile/modular units.
- [75A](#) – Required for all single-trip permits for mobile/modular units.
- [H](#) – Required for all overwidth permits.
- Permit [Weight Table 1](#), [3](#) or [4](#) – Required, depending upon which weight table is used.
- [Certified Flagger](#) – Required only when Certified Flaggers are required to safely cross a bridge a tunnel.

Other attachments, which are not required for SIPP permits.

- Permit [Weight Table 2](#) – required only when operating with legal axle weights, but not exceeding 105,500 pounds gross weight.
- [24 \(Splash and Spray\)](#) – required only when operating under Permit Weight Table 2.
- [100A](#) - a list of updates to maps and attachments, since the last printing.

List of Maps (for reference, not required for single-trip permits)

- [Group Map 1](#) – shows legal length limits for legal vehicles and loads. Occasionally used for pilot vehicle requirements.
- [Route Map 2](#) – used to determine pilot vehicle requirements for overwidth and/or overlength loads or vehicles.
- [Route Map 3](#) – issued with annual permit up to 14 feet 06 inches in height over many state maintained roads.
- [Route Map 6](#) – shows authorized annual routes up to 14 feet wide for mobile/modular units.
- [Route Map 7](#) – shows legal length limits for truck tractor/semitrailer and doubles combinations.
- [Route Map 8](#) – shows length restricted bridges on state maintained roads.
- [Route Map 9](#) – shows authorized annual routes up to 14 feet wide for heavy haul combinations.

Permit attachments and maps are subject to revision. It is the carrier's responsibility to ensure they have the most recent copies of the attachments and maps. These can be downloaded from www.oregontruckingonline.com. Attachments and maps can be obtained at the CCD offices in Salem and Portland, and most DMVs in the state.

Application Instructions

In [Oregon Trucking Online](#), 11 self-issue permit types are available. The correct type must be used, based on the hauling equipment and type of load.

- S01 – Truck Tractor/Semitrailer combination, legal axle and group axle weights.
- S03 – Truck Tractor/Semitrailer combination, heavy haul axle and group axle weights.
- S09 – Mobile Unit (on its' own axles).
- S09 – Modular Unit (hailed on a semitrailer).
- S18 – Tow Truck (hauling or towing wrecked or disabled vehicles or combinations)
- S30 – Truck Tractor/Semitrailer combination, overlength.
- S35 – Self-Propelled Vehicle with Boom Dolly.
- S37 – Self-Propelled Vehicle (Weight Table 3).
- S38 – Self-Propelled Vehicle (Weight Table 4).
- S39 – Heavy Haul Combination.
- S43 – Solo Vehicle.

Detailed information about each application follows. All fields are MANDATORY unless otherwise noted.

S01 – Truck Tractor/Semitrailer, Legal Weight

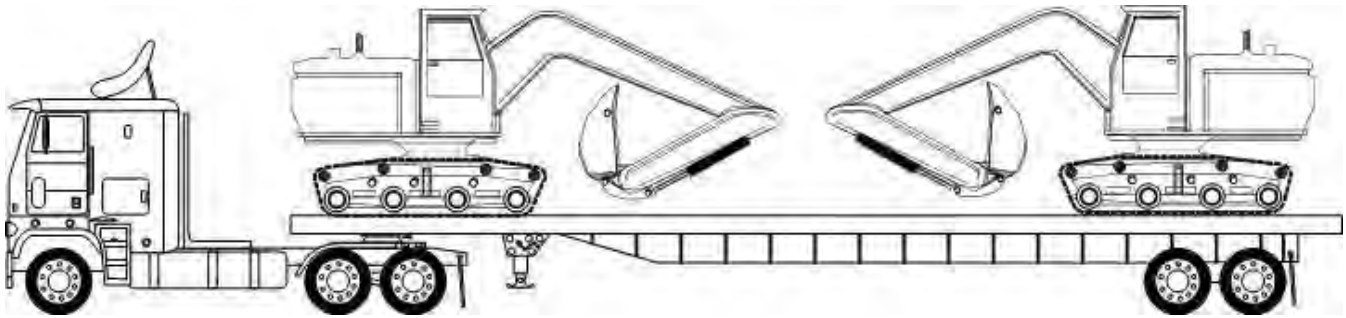

This permit class is intended for truck tractor/semitrailer combinations that are legal weight on all axles and groups of axles.

Carrier Information Section	
Contact Name	First and last name of the person issuing the permit.
Phone Number	10-digit phone number of the person issuing the permit.
Email	When the self-issue permit is issued, an email will be sent to this email address, advising where to print it. The default email address is the email address assigned to the Oregon Trucking Online Account.
Permit Effective Date	The date that you want the self-issue permit to be effective. Self-issue permits are valid for up to 10 days, and must expire no more than 14 days from today's date.
Permit Expiration Date	The date that you want the self-issue permit to expire. Self-issue permits are valid for up to 10 days, and must expire no more than 14 days from today's date.

Non-Divisible Load Dimensions Section	
Commodity	The specific item being hauled. Examples of <u>acceptable</u> entries include Backhoe, D6 Dozer With Blade, Air Handling Unit, or Pre-fabricated Wall Panels. Examples of <u>unacceptable</u> entries include Construction Equipment, Machinery, HVAC Parts, and Building Materials. Multiple items are allowed for this class of permit, provided oversize is not caused by items loaded in multiple.
Load Length	If the load is 40 feet or less in length, enter 40. If the load is greater than 40 feet in length, enter the total load length rounded up to the next foot. The maximum load length for this class of self-issue permit is 105 feet.
Width	The total overall width of the load or hauling equipment, whichever is greater. Round fractions of an inch up to the next highest inch. Legal width in Oregon is 8 feet 06 inches. Enter 8'06" if the width is 8 feet 06 inches or less. Enter the actual width if the width is more than 8 feet 06 inches. Hauling a legal width load on an overwidth trailer is not allowed. The maximum width allowed in the Self-Issue Permits Program is 14 feet 00 inches.

<p>Travel Height</p>	<p>The highest point of the load when loaded and ready for transport, as measured from the ground on a level surface. Round fractions of an inch up to the next highest inch. Legal height in Oregon is 14 feet 00 inches. Enter 14'00" if the height is 14 feet 00 inches or less. Enter the actual height if the height is more than 14 feet 00 inches.</p> <p>The maximum height allowed in the Self-Issue Permits Program is 15 feet 00 inches.</p>
<p>Overall Length</p>	<p>Total length of the hauling equipment and the load, including any front and/or rear overhangs, rounded up to the nearest foot. Multiple items loaded end to end cannot overhang the back of the semitrailer by more than 5 feet, subject to allowable overall lengths.</p> <p>An error message will appear if the following are keyed:</p> <ul style="list-style-type: none"> • The overall length is less than the load length. • The overall length is less than the trailer length. • If weights and spacings are provided, the overall length is less than the sum of the spacings. <p>The maximum overall length allowed in the Self-Issue Permits Program for a truck tractor/semitrailer combination is 105 feet.</p>
<p>Front Overhang</p>	<p>The distance that any part of the load extends beyond the forward most part of the body of the power unit. Legal front overhang is 4 feet 00 inches or less. Legal is the default. Enter the actual front overhang in feet when it exceeds 4 feet 00 inches, rounded up to the next highest foot.</p> <p>A load cannot have both excessive front and rear overhang at the same time.</p> <p>Refer to pilot vehicle table on Attachment 82A for pilots required for front overhang.</p> <p>Include language in special provisions "Load allowed to extend forward of the rear of the cab of the power unit" when the load on the semitrailer extends forward of the rear of the cab of the power unit.</p> <p>The maximum front overhang allowed in the Self-Issue Permits Program is 40 feet 00 inches.</p>

<p>Rear Overhang</p>	<p>Items loaded end to end or overlapping are not allowed to extend more than 5 feet 00 inches beyond the rear of the semitrailer. Choose Legal if the distance from the back of the semitrailer to the end of the load measures 5 feet 00 inches or less.</p> <p>When the distance for a single, non-divisible item exceeds 5 feet 00 inches, rear overhang is measured from the center of the last axle of the semitrailer to the end of the load, and is subject to overall length limits. Wheelbase is the distance from the center of the first axle of the combination, to the center of the last axle of the combination.</p> <p>Choose 1/3WB if rear overhang is less than or equal to 1/3 of the overall wheelbase of the combination.</p> <p>Choose 1/2WB if rear overhang is more than 1/3, but up to 1/2 of the overall wheelbase of the combination. The maximum rear overhang allowed in the Self-Issue Permits Program is 1/2 of the wheelbase, measured from the center of the last axle of the combination to the end of the load.</p> <p>Refer to Attachment 82A for flag and lighting requirements when a load extends off the rear of the semitrailer.</p>
<p>Gross Weight</p>	<p>For this class of self-issue permit, Legal (which is 80,000 pounds) is the default, and cannot be edited. The permit may be used in conjunction with a valid extended weight permit, issued to the power unit. See Special Provisions section for additional information.</p>
<p>Description of Vehicles</p>	<p>For this class of self-issue permit, Truck Tractor/Semitrailer is default, and cannot be edited.</p>
<p>Trailer Length</p>	<p>The length of the semitrailer, when fully deployed for transport.</p> <p>Fixed trailers cannot exceed 53 feet in length. If flip axles(s) are deployed, a flip neck extension is deployed, or pinned axle(s) are added, the maximum trailer length is 65 feet. These trailers must be reduced to 53 feet or less in length when unladen, or a permitted unladen authorization is required.</p> <p>Stretch and Expanded trailers are allowed up to 65 feet in length. These trailers must be reduced to 53 feet or less in length when unladen, or a permitted unladen authorization is required.</p> <p>Special Use and Tow-away trailers are allowed up to 65 feet in length.</p>

Trailer Type	<p>Choose Fixed if the trailer is not reducible in length.</p> <p>Choose Stretch if the trailer is a telescoping stretch trailer.</p> <p>Choose Expanded if the trailer length has been expanded with deck extensions.</p> <p>Choose Special Use if the trailer is built to haul one type of commodity only.</p> <p>Choose Tow-away if the equipment is permanently mounted to a trailer.</p> <p>At least one of the following options must be selected if a fixed trailer exceeds 53 feet in length:</p> <p>Choose Flip Axles(s) deployed if axles that can be flipped on the trailer are deployed to extend the hauling capacity of the trailer.</p> <p>Choose Flip Neck Extension if a gooseneck at the front of the trailer is flipped down, to adjust axle weights of the combination.</p> <p>Choose Pinned axle(s) if a separate vehicle is pinned to and does not pivot separately from the trailer, to add extra carrying capacity to the trailer.</p> <p>Both Flip Axle(s) deployed and Pinned axle(s) cannot be selected at the same time.</p> <p>These three options are not available for Special Use or Tow-away trailers.</p> <p>These three options are available, but not required, for Stretch and Expanded trailer types.</p>
Additional Info	<p>If the Fixed, Stretch, or Expanded trailer length exceeds 53 feet, choose one of the reasons why the increased trailer length is required.</p> <ul style="list-style-type: none"> • Trailer length required to reduce height of the load. • Trailer length required to support the load. • Trailer length required to accommodate weight of the load. <p>If Special Use is selected, indicate that the special use trailer is designed to haul only the commodity permitted.</p> <p>This option is not available for Tow-away trailers.</p>
Can the trailer be reduced...	<p>If the Fixed, Stretch, or Expanded trailer length exceeds 53 feet, indicate if the trailer can be reduced to 53 feet or less in length when unladen.</p> <p>If yes, a provision will be added to the permit, requiring the trailer to be reduced to 53 feet or less in length when unladen.</p> <p>If no, at least one unladen authorization is required for the excessive trailer length.</p> <p>This option is not available for Special Use or Tow-away trailers.</p>
Weight Table	<p>For this class of self-issue permit, Weight Table 1 is the only option, and cannot be edited. The permit may be used in conjunction with a valid extended weight permit, issued to the power unit. See Special Provisions section for additional information.</p>
Number of Axles	<p>The number of axles on the ground. This is not a required field for this permit class.</p>

List Dimensions Between Axles...	This area is mainly used for heavy haul purposes, and is required for Weight Table 3 or 4 permits. This information is not required for this this class of permit.
Group Axle Weights	This area is mainly used for heavy haul purposes, and is required for Weight Table 3 or 4 permits. This information is not required for this this class of permit.

Unladen Travel	
Unladen Travel Requested?	Choose Yes if unladen authorization is required because the hauling equipment (trailer and/or overall length) is exceeding the legal length limits shown on Group Map 1 and Route Map 7 .
How many segments...?	Up to two unladen segments are allowed on each single-trip permits. If the gross weight is in excess of 98,000 pounds. When unladen, a separate single-trip permit is required.

Route Section	
Start Location	Choose Yes if the laden move will begin at an Oregon border location. Choose the border location from the list. Choose No if the laden move will begin in Oregon. Key the exact City, and Address, Cross Street, or Milepoint.
End Location	Choose Yes if the laden move will end at an Oregon border location. Choose the border location from the list. Choose No if the laden move will end in Oregon. Key the exact City, and Address, Cross Street, or Milepoint.
Route Description	Key the exact route, in order of travel. Include exit numbers where appropriate.

Pilot Vehicle Section	
2 Lane	Check None if no pilot vehicles are required for width, height, or overall length on any two-lane highways on the laden route. Check Front if a front pilot vehicle is required for width, height, or overall length on any two-lane highways on the laden route. Check Rear if a rear pilot vehicle is required for width on any two-lane highways on the laden route.
4 Lane	Check None if no pilot vehicles are required for width, height, or overall length on any multilane highways on the laden route. Check Front if a front pilot vehicle is required for width, height, or overall length on any multilane highways on the laden route. Check Rear if a rear pilot vehicle is required for width or length on multilane highways on the laden route.

UNLADEN Load Dimensions Section	
Commodity	The default is Unladen Combination.
Load Length	The default is Legal .
Width	The total overall width of the hauling equipment.
Travel Height	The height of the hauling equipment as measured from a flat surface, ready for transport. Show the actual loaded height when operating greater than 14 feet 00 inches. Otherwise, indicate 14'00" .
Overall Length	The overall length of the hauling equipment.
Front Overhang	The default is Legal .
Rear Overhang	The default is Legal .
Gross Weight	For this class of self-issue permit, Legal (which is 80,000 pounds) is the default, and cannot be edited. The permit may be used in conjunction with a valid extended weight permit, issued to the power unit. See Special Provisions section for additional information.
Description of Vehicles	For this class of self-issue permit, Truck Tractor/Semitrailer is default, and cannot be edited.
Trailer Length	The length of the semitrailer, when fully deployed for transport. Fixed trailers cannot exceed 53 feet in length. If flip axles(s) are deployed, a flip neck extension is deployed, or pinned axle(s) are added, the maximum trailer length is 65 feet. Stretch and Expanded trailers are allowed up to 65 feet in length. Special Use and Tow-away trailers are allowed up to 65 feet in length.

Trailer Type	<p>Choose Fixed if the trailer is not reducible in length.</p> <p>Choose Stretch if the trailer is a telescoping stretch trailer.</p> <p>Choose Expanded if the trailer length has been expanded with deck extensions.</p> <p>Choose Special Use if the trailer is built to haul one type of commodity only.</p> <p>Choose Tow-away if the equipment is permanently mounted to a trailer.</p> <p>At least one of the following options must be selected if a fixed trailer exceeds 53 feet in length:</p> <p>Choose Flip Axles(s) deployed if axles that can be flipped on the trailer are deployed to extend the hauling capacity of the trailer.</p> <p>Choose Flip Neck Extension if a gooseneck at the front of the trailer is flipped down, to adjust axle weights of the combination.</p> <p>Choose Pinned axle(s) if a separate vehicle is pinned to and does not pivot separately from the trailer, to add extra carrying capacity to the trailer.</p> <p>Both Flip Axle(s) deployed and Pinned axle(s) cannot be selected at the same time.</p> <p>These three options are not available for Special Use or Tow-away trailers.</p> <p>These three options are available, but not required, for Stretch and Expanded trailer types.</p>
Weight Table	<p>For this class of self-issue permit, Weight Table 1 is the only option, and cannot be edited. The permit may be used in conjunction with a valid extended weight permit, issued to the power unit. See Special Provisions section for additional information.</p>
Number of Axles	<p>The number of axles on the ground. This is not a required field for this permit class.</p>
List dimensions between axles...	<p>This area is mainly used for heavy haul purposes, and is required for Weight Table 3 or 4 permits. This information is not required for this this class of permit.</p>
Group Axle Weights	<p>This area is mainly used for heavy haul purposes, and is required for Weight Table 3 or 4 permits. This information is not required for this this class of permit.</p>

UNLADEN Route(s) Section	
Start Location	Choose Yes if the unladen move will begin at an Oregon border location. Choose the border location from the list. Choose No if the unladen move will begin in Oregon. Key the exact City, and Address, Cross Street, or Milepoint.
End Location	Choose Yes if the unladen move will end at an Oregon border location. Choose the border location from the list. Choose No if the unladen move will end in Oregon. Key the exact City, and Address, Cross Street, or Milepoint.
Route Description	Key the exact route, in order of travel. Include exit numbers where appropriate.

UNLADEN Pilot Vehicle Section	
2 Lane	Check None if no pilot vehicles are required for width, height, or overall length on any two-lane highways on the unladen route. Check Front if a front pilot vehicle is required for width, height, or overall length on any two-lane highways on the unladen route. Check Rear if a rear pilot vehicle is required for width on two-lane highways on the unladen route.
4 Lane	Check None if no pilot vehicles are required for width, height, or overall length on any multilane highways on the unladen route. Check Front if a front pilot vehicle is required for width, height, or overall length on any multilane highways on the unladen route. Check Rear if a rear pilot vehicle is required for width on multilane highways on the unladen route.

Vehicle Information	
Do you know...?	<p>Choose Yes if you know the power unit plate and/or unit number. Key a plate or unit number, and click Add Vehicle.</p> <p>Choose No if you do not know the power unit plate and/or unit number. Either choose a range of unit numbers, or Show All Vehicles. Select a power unit from the list.</p> <p>One and only one power unit is allowed on self-issue permits. Use of Equipment List is not allowed on self-issue permits. Use of multiple vehicles or option of vehicles is not allowed on self-issue permits.</p>

Special Provisions	
Pilot Vehicle Requirements	Key specific pilot vehicle requirements, based on the overall length, width, and height of the permitted move. If the pilot vehicle requirements checked above apply to the entire route, key or check the box "See above for pilot vehicle requirements for entire route."
Road Restrictions	Key specific road, ramp, and/or bridge restrictions that apply to the permit, based on the route, overall length, width, weight, and height of the permitted move. If no road restrictions apply, key or check the box "No additional road restrictions required for this route at these dimensions."
Other Special Provisions	Key other special provisions, or check one (or more) of the boxes below. If no additional special provisions, key or check the box "No additional special provisions required for this permit."
This permit may be used in conjunction...	Check this box if a valid extended weight permit has been issued to the truck, and the carrier will use this self-issue permit in conjunction with it.
** Either certified flaggers...	Check this box if the permittee is required to straddle the centerline or use the certified rolling method to safely cross through a structure, due to the height and/or width. The ** is used in the Route to specify the structure where traffic control is required. The Certified Flagger attachment will automatically be added as a requirement. The 18 locations where this is allowed are shown on Route Map 2 .
** Certified flaggers...	Check this box if the permittee is required to straddle the centerline to safely cross through a structure, due to the height and/or width. The ** is used in the Route to specify the structure where traffic control is required. The Certified Flagger Attachment will automatically be added as a requirement.
Front pilot vehicle must be equipped...	This checkbox will appear if the load is more than 14 feet 06 inches in height, and the carrier does not have a height declaration on file. The box cannot be unchecked.

Final Details	
Location	<p>If TOL is chosen, the permit will only appear in the carrier's TOL reprint area. The carrier will need to log in to their TOL account to obtain the permit.</p> <p>If HOSTFAX is chosen, please provide a 10-digit fax number, or up to 4-digit INC code in the Hostfax Number field. In addition to the carrier's TOL reprint area, the permit will be sent to this fax number.</p>
Checkbox	The person issuing the permit must read the text, and check the box, if they agree.

S03 – Truck Tractor/Semitrailer, Heavy Haul Weights

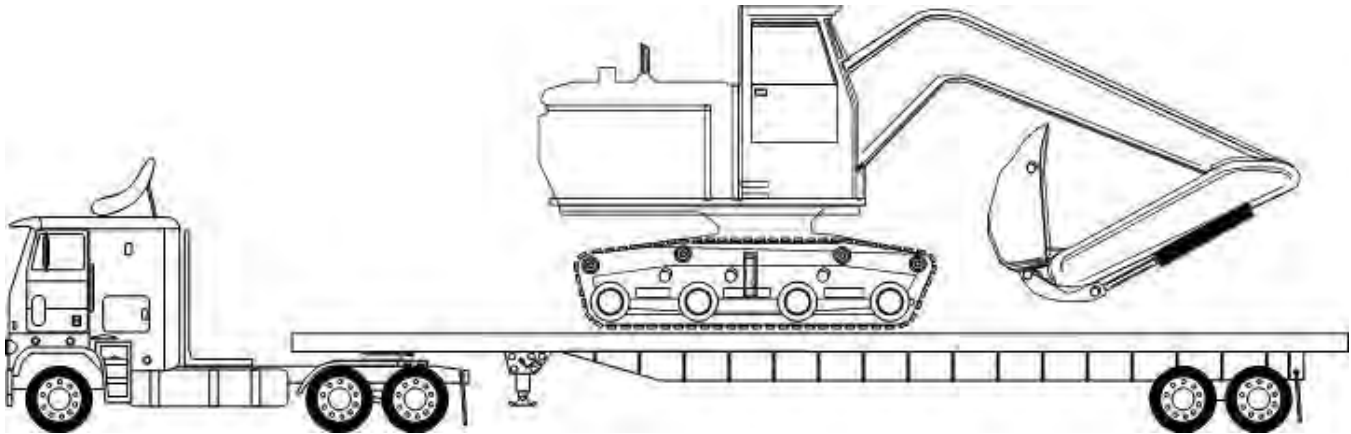

This permit class is intended for truck tractor/semitrailer combinations that are operating with heavy haul axle and/or group axle weights, up to [Weight Table 4](#).

Carrier Information Section	
Contact Name	First and last name of the person issuing the permit.
Phone Number	10-digit phone number of the person issuing the permit.
Email	When the self-issue permit is issued, an email will be sent to this email address, advising where to print it. The default email address is the email address assigned to the Oregon Trucking Online Account.
Permit Effective Date	The date that you want the self-issue permit to be effective. Self-issue permits are valid for up to 10 days, and must expire no more than 14 days from today's date.
Permit Expiration Date	The date that you want the self-issue permit to expire. Self-issue permits are valid for up to 10 days, and must expire no more than 14 days from today's date.

Non-Divisible Load Dimensions Section	
Commodity	The specific item being hauled. Examples of <u>acceptable</u> entries include Backhoe, D6 Dozer With Blade, or Air Handling Unit. Examples of <u>unacceptable</u> entries include Construction Equipment, Machinery, HVAC Parts, and Building Materials. Multiple items are NOT allowed for this class of permit. The commodity hauled must be a single, non-divisible load.
Load Length	If the load is 40 feet or less in length, enter 40 . If the load is greater than 40 feet in length, enter the total load length rounded up to the next foot. The maximum load length for this class of self-issue permit is 105 feet.

Width	<p>The total overall width of the load or hauling equipment, whichever is greater. Round fractions of an inch up to the next highest inch. Legal width in Oregon is 8 feet 06 inches. Enter 8'06" if the width is 8 feet 06 inches or less. Enter the actual width if the width is more than 8 feet 06 inches. Hauling a legal width load on an overwidth trailer is not allowed.</p> <p>The maximum width allowed in the Self-Issue Permits Program is 14 feet 00 inches.</p>
Travel Height	<p>The highest point of the load when prepared and ready for transport, as measured from the ground on a level surface. Round fractions of an inch up to the next highest inch. Legal height in Oregon is 14 feet 00 inches. Enter 14'00" if the height is 14 feet 00 inches or less. Enter the actual height if the height is more than 14 feet 00 inches.</p> <p>The maximum height allowed in the Self-Issue Permits Program is 15 feet 00 inches.</p>
Overall Length	<p>Total length of the hauling equipment and the load, including any front and/or rear overhangs, rounded up to the nearest foot. Multiple items loaded end to end cannot overhang the back of the semitrailer length by more than 5 feet, subject to allowable overall lengths. An error message will appear if the following are keyed:</p> <ul style="list-style-type: none"> • The overall length is less than the load length. • The overall length is less than the trailer length. • The overall length is less than the sum of the spacings provided in the weights and spacings section. <p>The maximum overall length allowed in the Self-Issue Permits Program for a truck tractor/semitrailer combination is 105 feet.</p>
Front Overhang	<p>The distance that any part of the load extends beyond the forward most part of the body of the power unit. Legal front overhang is 4 feet 00 inches. Enter Legal if front overhang is 4 feet 00 inches or less. Enter the actual front overhang in feet when it exceeds 4 feet 00 inches, rounded up to the next highest foot.</p> <p>A load cannot have both excessive front and rear overhang at the same time.</p> <p>Refer to pilot vehicle table on Attachment 82A for pilots required for front overhang.</p> <p>Include language in special provisions "Load allowed to extend forward of the rear of the cab of the power unit" when the load on the semitrailer extends forward of the rear of the cab of the power unit.</p> <p>The maximum front overhang allowed in the Self-Issue Permits Program is 40 feet 00 inches.</p>

<p>Rear Overhang</p>	<p>Items loaded end to end or overlapping are not allowed to extend more than 5 feet 00 inches beyond the rear of the semitrailer. Choose Legal if the distance from the back of the semitrailer to the end of the load measures 5 feet 00 inches or less.</p> <p>When the distance for a single, non-divisible item exceeds 5 feet 00 inches, rear overhang is measured from the center of the last axle of the semitrailer to the end of the load, and is subject to overall length limits. Wheelbase is the distance from the center of the first axle of the combination, to the center of the last axle of the combination.</p> <p>Choose 1/3WB if rear overhang is less than or equal to 1/3 of the overall wheelbase of the combination.</p> <p>Choose 1/2WB if rear overhang is more than 1/3, up to 1/2 of the overall wheelbase of the combination. The maximum rear overhang allowed in the Self-Issue Permits Program is 1/2 of the wheelbase, measured from the center of the last axle of the combination to the end of the load.</p> <p>Refer to Attachment 82A for flag and lighting requirements when a load extends off the rear of the semitrailer.</p>
<p>Gross Weight</p>	<p>Key the gross weight of the hauling equipment and load, in pounds. The maximum gross weight allowed in the Self-Issue Permits Program is 200,000 pounds.</p>
<p>Description of Vehicles</p>	<p>For this class of permit, Truck Tractor/Semitrailer is the only option, and cannot be edited.</p>
<p>Trailer Length</p>	<p>The length of the semitrailer, when fully deployed for transport.</p> <p>Fixed trailers cannot exceed 53 feet in length. If flip axles(s) are deployed, a flip neck extension is deployed, or pinned axle(s) are added, the maximum trailer length is 65 feet. These trailers must be reduced to 53 feet or less in length when unladen, or a permitted unladen authorization is required.</p> <p>Stretch and Expanded trailers are allowed up to 65 feet in length. These trailers must be reduced to 53 feet or less in length when unladen, or a permitted unladen authorization is required.</p> <p>Special Use and Tow-away trailers are allowed up to 65 feet in length.</p>

<p>Trailer Type</p>	<p>Choose Fixed if the trailer is not reducible in length.</p> <p>Choose Stretch if the trailer is a telescoping stretch trailer.</p> <p>Choose Expanded if the trailer length has been expanded with deck extensions.</p> <p>Choose Special Use if the trailer is built to haul one type of commodity only.</p> <p>Choose Tow-away if the equipment is permanently mounted to a trailer.</p> <p>At least one of the following options must be selected if a fixed trailer exceeds 53 feet in length:</p> <p>Choose Flip Axle(s) deployed if axles that can be flipped on the trailer are deployed to extend the hauling capacity of the trailer.</p> <p>Choose Flip Neck Extension if a gooseneck at the front of the trailer is flipped down, to adjust axle weights of the combination.</p> <p>Choose Pinned axle(s) if a separate vehicle is pinned to and does not pivot separately from the trailer, to add extra carrying capacity to the trailer.</p> <p>Both Flip Axle(s) deployed and Pinned axle(s) cannot be selected at the same time.</p> <p>These three options are not available for Special Use or Tow-away trailers.</p> <p>These three options are available, but not required, for Stretch and Expanded trailer types.</p>
<p>Additional Info</p>	<p>If the Fixed, Stretch, or Expanded trailer length exceeds 53 feet, choose one of the reasons why the increased trailer length is required.</p> <ul style="list-style-type: none"> • Trailer length required to reduce height of the load. • Trailer length required to support the load. • Trailer length required to accommodate weight of the load. <p>If Special Use is selected, indicate that the special use trailer is designed to haul only the commodity permitted.</p> <p>This option is not available for Tow-away trailers.</p>
<p>Can the trailer be reduced...</p>	<p>If the Fixed, Stretch, or Expanded trailer length exceeds 53 feet, indicate if the trailer can be reduced to 53 feet or less in length when unladen.</p> <p>If yes, a provision will be added to the permit, requiring the trailer to be reduced to 53 feet or less in length when unladen.</p> <p>If no, at least one unladen authorization is required for the excessive trailer length.</p> <p>This option is not available for Special Use or Tow-away trailers.</p>
<p>Weight Table</p>	<p>For this class of permit, Weight Table 3 or 4 are the only options. The weight table chosen must match the weight table calculated by the weights and spacings provided below.</p>
<p>Number of Axles</p>	<p>The number of axles on the ground. All available axles must be deployed when operating under a heavy haul permit.</p>

Optionally, select a saved Weight Analysis...	If you have a weight analysis saved from the Calculate Oregon Weights application in the OD Menu of TOL, select it from the list. You will still need to key the Weight Table, Number of Axles, and Gross Weight.
List dimensions between axles...	This information is required for this class of self-issue permits, and is used to calculate and confirm the appropriate weight table.
Group Axle Weights	This information is required for this class of self-issue permits, and is used to calculate and confirm the appropriate weight table.

Unladen Travel	
Unladen Travel Requested?	Choose Yes if unladen authorization is required because the hauling equipment (trailer and/or overall length) is exceeding the legal length limits shown on Group Map 1 and Route Map 7 .
How many segments...?	Up to two unladen segments are allowed on each single-trip permits. If the gross weight is in excess of 98,000 pounds when unladen, a separate single-trip permit is required.

Route Section	
Start Location	Choose Yes if the laden move will begin at an Oregon border location. Choose the border location from the list. Choose No if the laden move will begin in Oregon. Key the exact City, and Address, Cross Street, or Milepoint.
End Location	Choose Yes if the laden move will end at an Oregon border location. Choose the border location from the list. Choose No if the laden move will end in Oregon. Key the exact City, and Address, Cross Street, or Milepoint.
Route Description	Key the exact route, in order of travel. Include exit numbers where appropriate.

Pilot Vehicle Section	
2 Lane	Check None if no pilot vehicles are required for width, height, or overall length on any two-lane highways on the laden route. Check Front if a front pilot vehicle is required for width, height, or overall length on any two-lane highways on the laden route. Check Rear if a rear pilot vehicle is required for width on any two-lane highways on the laden route.
4 Lane	Check None if no pilot vehicles are required for width, height, or overall length on any multilane highways on the laden route. Check Front if a front pilot vehicle is required for width, height, or overall length on any multilane highways on the laden route. Check Rear if a rear pilot vehicle is required for width or length on multilane highways on the laden route.

UNLADEN Load Dimensions Section	
Commodity	The default is Unladen Combination.
Load Length	The default is Legal .
Width	The total overall width of the hauling equipment.
Travel Height	Height of the hauling equipment as measured from a flat surface, ready for transport. Show the actual loaded height when operating greater than 14 feet 00 inches. Otherwise indicate 14'00" .
Overall Length	The overall length of the hauling equipment.
Front Overhang	The default is Legal .
Rear Overhang	The default is Legal .
Gross Weight	The default is Legal . The maximum gross weight for an unladen section of a single-trip permit is 98,000 pounds.
Description of Vehicles	The default is Truck Tractor/Semitrailer.
Trailer Length	The length of the semitrailer, when fully deployed for transport. Fixed trailers cannot exceed 53 feet in length. If flip axles(s) are deployed, a flip neck extension is deployed, or pinned axle(s) are added, the maximum trailer length is 65 feet. Stretch and Expanded trailers are allowed up to 65 feet in length. Special Use and Tow-away trailers are allowed up to 65 feet in length.

Trailer Type	<p>Choose Fixed if the trailer is not reducible in length.</p> <p>Choose Stretch if the trailer is a telescoping stretch trailer.</p> <p>Choose Expanded if the trailer length has been expanded with deck extensions.</p> <p>Choose Special Use if the trailer is built to haul one type of commodity only.</p> <p>Choose Tow-away if the equipment is permanently mounted to a trailer.</p> <p>At least one of the following options must be selected if a fixed trailer exceeds 53 feet in length:</p> <p>Choose Flip Axle(s) deployed if axles that can be flipped on the trailer are deployed to extend the hauling capacity of the trailer.</p> <p>Choose Flip Neck Extension if a gooseneck at the front of the trailer is flipped down, to adjust axle weights of the combination.</p> <p>Choose Pinned axle(s) if a separate vehicle is pinned to and does not pivot separately from the trailer, to add extra carrying capacity to the trailer.</p> <p>Both Flip Axle(s) deployed and Pinned axle(s) cannot be selected at the same time.</p> <p>These three options are not available for Special Use or Tow-away trailers.</p> <p>These three options are available, but not required, for Stretch and Expanded trailer types.</p>
Weight Table	For this class of permit, Weight Table 1 , 3 , or 4 are the only options.
Number of Axles	The number of axles on the ground. This is a required field if Weight Table 3 or 4 is selected.
List dimensions between axles...	This information is required for this class of self-issue permits, if Weight Table 3 or 4 is selected as part of the unladen authorization, and is used to calculate and confirm the appropriate weight table when unladen.
Group Axle Weights	This information is required for this class of self-issue permits, if Weight Table 3 or 4 is selected as part of the unladen authorization, and is used to calculate and confirm the appropriate weight table when unladen.

UNLADEN Route(s) Section	
Start Location	Choose Yes if the unladen move will begin at an Oregon border location. Choose the border location from the list. Choose No if the unladen move will begin in Oregon. Key the exact City, and Address, Cross Street, or Milepoint.
End Location	Choose Yes if the unladen move will end at an Oregon border location. Choose the border location from the list. Choose No if the unladen move will end in Oregon. Key the exact City, and Address, Cross Street, or Milepoint.
Route Description	Key the exact route, in order of travel. Include exit numbers where appropriate.

UNLADEN Pilot Vehicle Section	
2 Lane	Check None if no pilot vehicles are required for width, height, or overall length on any two-lane highways on the unladen route. Check Front if a front pilot vehicle is required for width, height, or overall length on any two-lane highways on the unladen route. Check Rear if a rear pilot vehicle is required for width on two-lane highways on the unladen route.
4 Lane	Check None if no pilot vehicles are required for width, height, or overall length on any multilane highways on the unladen route. Check Front if a front pilot vehicle is required for width, height, or overall length on any multilane highways on the unladen route. Check Rear if a rear pilot vehicle is required for width on multilane highways on the unladen route.

Vehicle Information	
Do you know...?	<p>Choose Yes if you know the power unit plate and/or unit number. Key a plate or unit number, and click Add Vehicle.</p> <p>Choose No if you do not know the power unit plate and/or unit number. Either choose a range of unit numbers, or Show All Vehicles. Select a power unit from the list.</p> <p>One and only one power unit is allowed on self-issue permits. Use of Equipment List is not allowed on self-issue permits. Use of multiple vehicles or option of vehicles is not allowed on self-issue permits.</p>

Special Provisions	
Pilot Vehicle Requirements	Key specific pilot vehicle requirements, based on the overall length, width, and height of the permitted move. If the pilot vehicle requirements checked above apply to the entire route, key or check the box "See above for pilot vehicle requirements for entire route."
Road Restrictions	Key specific road, ramp, and/or bridge restrictions that apply to the permit, based on the route, overall length, width, weight, and height of the permitted move. If no road restrictions apply, key or check the box "No additional road restrictions required for this route at these dimensions."
Other Special Provisions	Key other special provisions, or check one (or more) of the boxes below. If no additional special provisions, key or check the box "No additional special provisions required for this permit."
** Either certified flaggers...	Check this box if the permittee is required to straddle the centerline or use the certified rolling method to safely cross through a structure, due to the height and/or width. The ** is used in the Route to specify the structure where traffic control is required. The Certified Flagger attachment will automatically be added as a requirement. The 18 locations where this is allowed are shown on Route Map 2 .
** Certified flaggers...	Check this box if the permittee is required to straddle the centerline to safely cross through a structure, due to the height and/or width. The ** is used in the Route to specify the structure where traffic control is required. The Certified Flagger Attachment will automatically be added as a requirement.
Front pilot vehicle must be equipped...	This checkbox will appear if the load is more than 14 feet 06 inches in height, and the carrier does not have a height declaration on file. The box cannot be unchecked.

Final Details	
Location	<p>If TOL is chosen, the permit will only appear in the carrier's TOL reprint area. The carrier will need to log in to their TOL account to obtain the permit.</p> <p>If HOSTFAX is chosen, please provide a 10-digit fax number, or up to 4-digit INC code in the Hostfax Number field. In addition to the carrier's TOL reprint area, the permit will be sent to this fax number.</p>
Checkbox	The person issuing the permit must read the text, and check the box, if they agree.

S09 – Mobile Unit

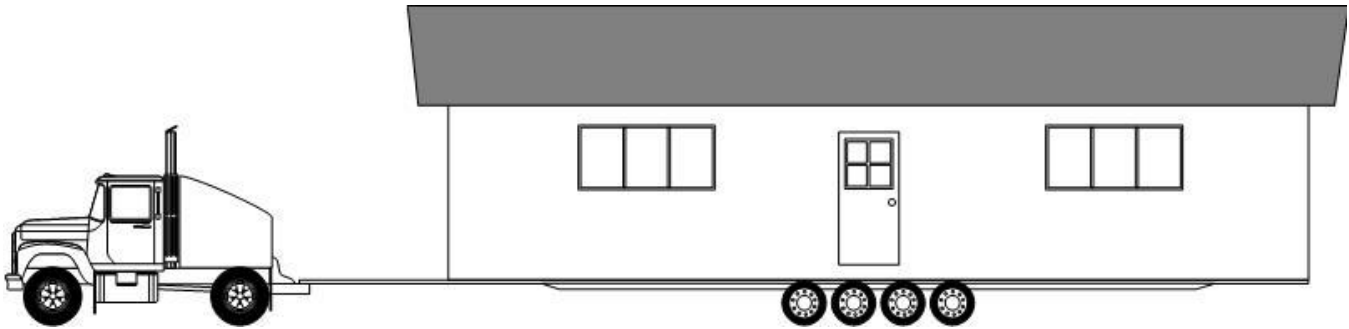

This permit class is intended for toter/mobile unit combinations that are legal weight on all axles and groups of axles. Mobile units are towed on their own axles.

Carrier Information Section	
Contact Name	First and last name of the person issuing the permit.
Phone Number	10-digit phone number of the person issuing the permit.
Email	When the self-issue permit is issued, an email will be sent to this email address, advising where to print it. The default email address is the email address assigned to the Oregon Trucking Online Account.
Permit Effective Date	The date that you want the self-issue permit to be effective. Self-issue permits are valid for up to 10 days, and must expire no more than 14 days from today's date.
Permit Expiration Date	The date that you want the self-issue permit to expire. Self-issue permits are valid for up to 10 days, and must expire no more than 14 days from today's date.

Non-Divisible Load Dimensions Section	
Commodity	For this class of self-issue permit, Mobile Unit is the default, and cannot be edited.
Load Length	If the load is 40 feet or less in length, enter 40 . If the load is greater than 40 feet in length, enter the total load length rounded up to the next foot. The maximum load length for this class of self-issue permit is 80 feet.
Base Width	The base width of the mobile unit. The maximum base width allowed in the Self-Issue Permits Program is 14 feet 00 inches.
Eave Width	The eave width of the mobile unit, if any. The maximum eave width allowed in the Self-Issue Permits Program is 2 feet 00 inches.
Overall Width	The sum of the base width and eave width. The maximum overall width allowed in the Self-Issue Permits Program is 14 feet 00 inches.

Travel Height	<p>The highest point of the load when loaded and ready for transport, as measured from the ground on a level surface. Round fractions of an inch up to the next highest inch. Legal height in Oregon is 14 feet 00 inches. Enter 14'00" if the height is 14 feet 00 inches or less. Enter the actual height if the height is more than 14 feet 00 inches.</p> <p>The maximum height allowed in the Self-Issue Permits Program is 15 feet 00 inches.</p>
Overall Length	<p>Total length of the toter and mobile unit, rounded up to the nearest foot. An error message will appear if the following are keyed:</p> <ul style="list-style-type: none"> • The overall length is less than the load length. • If weights and spacings are provided, the overall length is less than the sum of the spacings. <p>The maximum overall length allowed in the Self-Issue Permits Program for a toter/mobile unit combination is 110 feet.</p>
Rear Overhang	<p>The distance that the load extends beyond the rear of the semitrailer. For this class of self-issue permit, this must be LEGAL.</p>
Gross Weight	<p>For this class of self-issue permit, Legal (which is 80,000 pounds) is the default, and cannot be edited.</p>
Description of Vehicles	<p>For this class of self-issue permit, Toter/Mobile Unit is default, and cannot be edited.</p>
Unit Serial Number	<p>The Serial Number of the mobile unit being towed.</p>
Weight Table	<p>For this class of self-issue permit, Weight Table 1 is the only option, and cannot be edited.</p>
Number of Axles	<p>The number of axles on the ground. This is not a required field for this permit class.</p>
List dimensions between axles...	<p>This area is mainly used for heavy haul purposes, and is required for Weight Table 3 or 4 permits. This information is not required for this this class of permit.</p>
Group Axle Weights	<p>This area is mainly used for heavy haul purposes, and is required for Weight Table 3 or 4 permits. This information is not required for this this class of permit.</p>

Route Section	
Start Location	<p>Choose Yes if the laden move will begin at an Oregon border location. Choose the border location from the list. Choose No if the laden move will begin in Oregon. Key the exact City, and Address, Cross Street, or Milepoint.</p>
End Location	<p>Choose Yes if the laden move will end at an Oregon border location. Choose the border location from the list. Choose No if the laden move will end in Oregon. Key the exact City, and Address, Cross Street or Milepoint.</p>

Route Section	
Route Description	Key the exact route, in order of travel. Include exit numbers where appropriate.

Pilot Vehicle Section	
2 Lane	Check None if no pilot vehicles are required for width, height, or overall length on any two-lane highways on the laden route. Check Front if a front pilot vehicle is required for width, height, or overall length on any two-lane highways on the laden route. Check Rear if a rear pilot vehicle is required for width on any two-lane highways on the laden route.
4 Lane	Check None if no pilot vehicles are required for width, height, or overall length on any multilane highways on the laden route. Check Front if a front pilot vehicle is required for width, height, or overall length on any multilane highways on the laden route. Check Rear if a rear pilot vehicle is required for width or length on multilane highways on the laden route.

Vehicle Information	
Do you know...?	<p>Choose Yes if you know the power unit plate and/or unit number. Key a plate or unit number, and click Add Vehicle.</p> <p>Choose No if you do not know the power unit plate and/or unit number. Either choose a range of unit numbers, or Show All Vehicles. Select a power unit from the list.</p> <p>One and only one power unit is allowed on self-issue permits. Use of Equipment List is not allowed on self-issue permits. Use of multiple vehicles or option of vehicles is not allowed on self-issue permits.</p>

Special Provisions	
Pilot Vehicle Requirements	Key specific pilot vehicle requirements, based on the overall length, width, and height of the permitted move. If the pilot vehicle requirements checked above apply to the entire route, key or check the box "See above for pilot vehicle requirements for entire route."
Road Restrictions	Key specific road, ramp, and/or bridge restrictions that apply to the permit, based on the route, overall length, width, weight, and height of the permitted move. If no road restrictions apply, key or check the box "No additional road restrictions required for this route at these dimensions."
Other Special Provisions	Key other special provisions, or check one (or more) of the boxes below. If no additional special provisions, key or check the box "No additional special provisions required for this permit."

** Either certified flaggers...	Check this box if the permittee is required to straddle the centerline or use the certified rolling method to safely cross through a structure, due to the height and/or width. The ** is used in the Route to specify the structure where traffic control is required. The Certified Flagger Attachment will automatically be added as a requirement. The 18 locations where this is allowed are shown on Route Map 2 .
** Certified flaggers...	Check this box if the permittee is required to straddle the centerline to safely cross through a structure, due to the height and/or width. The ** is used in the Route to specify the structure where traffic control is required. The Certified Flagger Attachment will automatically be added as a requirement.
Front pilot vehicle must be equipped...	This checkbox will appear if the load is more than 14 feet 06 inches in height, and the carrier does not have a height declaration on file. The box cannot be unchecked.

Final Details	
Location	<p>If TOL is chosen, the permit will only appear in the carrier's TOL reprint area. The carrier will need to log in to their TOL account to obtain the permit.</p> <p>If HOSTFAX is chosen, please provide a 10-digit fax number, or up to 4-digit INC code in the Hostfax Number field. In addition to the carrier's TOL reprint area, the permit will be sent to this fax number.</p>
Checkbox	The person issuing the permit must read the text, and check the box, if they agree.

S09 – Modular Unit

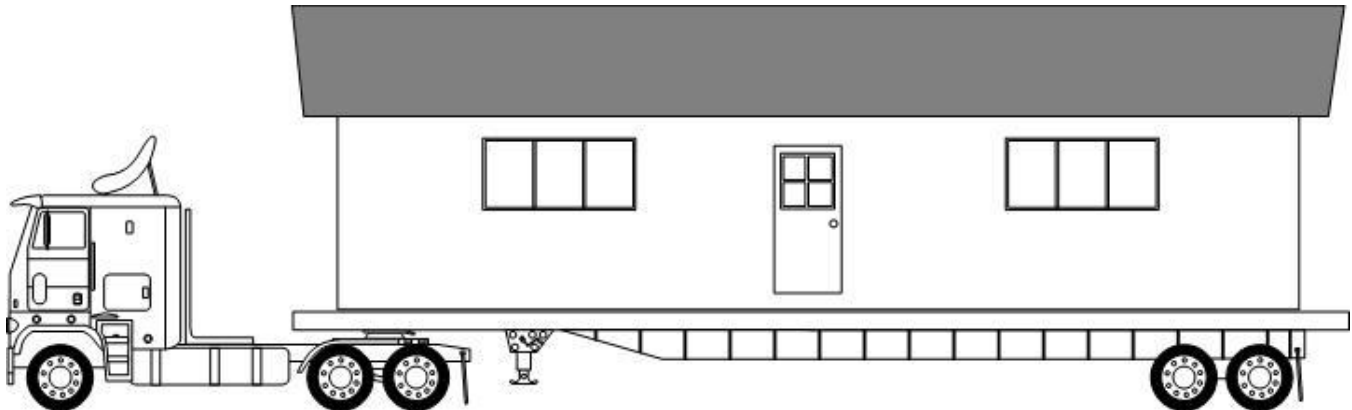

This permit class is intended for hauling a modular unit on a trailer or dolly.

Carrier Information Section	
Contact Name	First and last name of the person issuing the permit.
Phone Number	10-digit phone number of the person issuing the permit.
Email	When the self-issue permit is issued, an email will be sent to this email address, advising where to print it. The default email address is the email address assigned to the Oregon Trucking Online Account.
Permit Effective Date	The date that you want the self-issue permit to be effective. Self-issue permits are valid for up to 10 days, and must expire no more than 14 days from today's date.
Permit Expiration Date	The date that you want the self-issue permit to expire. Self-issue permits are valid for up to 10 days, and must expire no more than 14 days from today's date.

Non-Divisible Load Dimensions Section	
Commodity	For this class of self-issue permit, Modular Unit is the default, and cannot be edited.
Load Length	If the load is 40 feet or less in length, enter 40 . If the load is greater than 40 feet in length, enter the total load length rounded up to the next foot. The maximum load length for this class of self-issue permit is 80 feet.
Base Width	The base width of the modular unit. The maximum base width allowed in the Self-Issue Permits Program is 14 feet 00 inches.
Eave Width	Eave width of the modular unit, if any. The maximum eave width allowed in the Self-Issue Permits Program is 2 feet 00 inches.
Overall Width	The sum of the base width and eave width. The maximum overall width allowed in the Self-Issue Permits Program is 14 feet 00 inches.

Travel Height	<p>The highest point of the load when loaded and ready for transport, as measured from the ground on a level surface. Round fractions of an inch up to the next highest inch. Legal height in Oregon is 14 feet 00 inches. Enter 14'00" if the height is 14 feet 00 inches or less. Enter the actual height if the height is more than 14 feet 00 inches.</p> <p>The maximum height allowed in the Self-Issue Permits Program is 15 feet 00 inches.</p>
Overall Length	<p>Total length of the hauling equipment and the load, including any front and/or rear overhangs, rounded up to the nearest foot.</p> <p>An error message will appear if the following are keyed:</p> <ul style="list-style-type: none"> • The overall length is less than the load length. • The overall length is less than the trailer length. • If weights and spacings are provided, the overall length is less than the sum of the spacings. <p>The maximum overall length allowed in the Self-Issue Permits when hauling a modular unit is 110 feet.</p>
Rear Overhang	<p>The distance that the load extends beyond the rear of the semitrailer. For this class of self-issue permit, this must be LEGAL.</p>
Gross Weight	<p>For this class of self-issue permit, Legal (which is 80,000 pounds) is the default, and cannot be edited.</p>
Description of Vehicles	<p>For this class of self-issue permit, Truck Tractor/Semitrailer is default, but can be edited.</p>
Unit Serial Number	<p>The Serial Number of the modular unit being hauled.</p>
Trailer Type	<p>Choose Fixed if the trailer is not reducible in length. Choose Stretch if the trailer is a telescoping stretch trailer that can be reduced to 53 feet or less in length when unladen. Choose Expanded if the trailer length has been expanded with deck extensions. Choose Dolly if the load is supported by a dolly.</p>
Trailer Length	<p>The length of the semitrailer, when fully deployed for transport. Fixed trailers cannot exceed 53 feet in length in this permit class.</p> <p>Stretched or expanded trailers in excess of 53 feet are allowed. Stretched trailers must be reduced to 53 feet or less in length when unladen. Unladen authorization is required for expanded trailers in excess of 53 feet, if special equipment is required to reduce the trailer to legal length.</p> <p>The maximum stretch or expanded in length allowed for truck tractor/semitrailer combinations in the Self-Issue Permits Program is 75 feet.</p>
Weight Table	<p>For this class of self-issue permit, Weight Table 1 is the only option, and cannot be edited.</p>
Number of Axles	<p>The number of axles on the ground. This is not a required field for this permit class.</p>

Optionally, select a saved Weight Analysis...	If you have a saved weight analysis, select it from the list. You will still need to key the Weight Table, Number of Axles, and Gross Weight.
List dimensions between axles...	This area is mainly used for heavy haul purposes, and is required for Weight Table 3 or 4 permits. This information is not required for this this class of permit.
Group Axle Weights	This area is mainly used for heavy haul purposes, and is required for Weight Table 3 or 4 permits. This information is not required for this this class of permit.

Unladen Travel	
Unladen Travel Requested?	Choose Yes if unladen authorization is required because the hauling equipment (trailer and/or overall length) is exceeding the legal length limits shown on Group Map 1 and Route Map 7.
How many segments...?	Up to two unladen segments are allowed on each single-trip permits. If the gross weight is in excess of 98,000 pounds when unladen, a separate single-trip permit is required.

Route Section	
Start Location	Choose Yes if the laden move will begin at an Oregon border location. Choose the border location from the list. Choose No if the laden move will begin in Oregon. Key the exact City, and Address, Cross Street, or Milepoint.
End Location	Choose Yes if the laden move will end at an Oregon border location. Choose the border location from the list. Choose No if the laden move will end in Oregon. Key the exact City, and Address, Cross Street, or Milepoint.
Route Description	Key the exact route, in order of travel. Include exit numbers where appropriate.

Pilot Vehicle Section	
2 Lane	Check None if no pilot vehicles are required for width, height, or overall length on any two-lane highways on the laden route. Check Front if a front pilot vehicle is required for width, height, or overall length on any two-lane highways on the laden route. Check Rear if a rear pilot vehicle is required for width on any two-lane highways on the laden route.
4 Lane	Check None if no pilot vehicles are required for width, height, or overall length on any multilane highways on the laden route. Check Front if a front pilot vehicle is required for width, height, or overall length on any multilane highways on the laden route. Check Rear if a rear pilot vehicle is required for width or length on multilane highways on the laden route.

UNLADEN Load Dimensions Section	
Commodity	The default is Unladen Combination.
Load Length	The default is Legal .
Width	The total overall width of the hauling equipment.
Travel Height	Height of the hauling equipment as measured from a flat surface, ready for transport. Show the actual loaded height when operating greater than 14 feet 00 inches. Otherwise, indicate 14'00" .
Overall Length	The overall length of the hauling equipment.
Front Overhang	The default is Legal .
Rear Overhang	The default is Legal .
Gross Weight	For this class of self-issue permit, Legal (which is 80,000 pounds) is the default, and cannot be edited. The permit may be used in conjunction with a valid extended weight permit, issued to the power unit. See Special Provisions section for additional information.
Description of Vehicles	For this class of self-issue permit, Truck Tractor/Semitrailer is default, and cannot be edited.
Trailer Type	Choose Fixed if the trailer is not reducible in length. Choose Stretch if the trailer is a telescoping stretch trailer, and provide the reason why the stretch trailer is required. Choose Expanded if the trailer length has been expanded with deck extensions.
Trailer Length	The length of the semitrailer. Fixed trailers cannot exceed 53 feet in length in this class of self-issue permit. Stretched or expanded trailers up to 65 feet in length are allowed. Stretched trailers must be reduced to 53 feet or less in length when unladen. Unladen authorization is required for expanded trailers in excess of 53 feet, if special equipment is required to reduce the trailer to legal length.
Weight Table	For this class of self-issue permit, Weight Table 1 is the only option, and cannot be edited. The permit may be used in conjunction with a valid extended weight permit, issued to the power unit. See Special Provisions section for additional information.
Number of Axles	The number of axles on the ground. This is not a required field for this permit class.
List dimensions between axles...	This area is mainly used for heavy haul purposes, and is required for Weight Table 3 or 4 permits. This information is not required for this this class of permit.
Group Axle Weights	This area is mainly used for heavy haul purposes, and is required for Weight Table 3 or 4 permits. This information is not required for this this class of permit.

UNLADEN Route(s) Section	
Start Location	Choose Yes if the unladen move will begin at an Oregon border location. Choose the border location from the list. Choose No if the unladen move will begin in Oregon. Key the exact City, and Address, Cross Street, or Milepoint.
End Location	Choose Yes if the unladen move will end at an Oregon border location. Choose the border location from the list. Choose No if the unladen move will end in Oregon. Key the exact City, and Address, Cross Street, or Milepoint.
Route Description	Key the exact route, in order of travel. Include exit numbers where appropriate.

UNLADEN Pilot Vehicle Section	
2 Lane	Check None if no pilot vehicles are required for width, height, or overall length on any two-lane highways on the unladen route. Check Front if a front pilot vehicle is required for width, height, or overall length on any two-lane highways on the unladen route. Check Rear if a rear pilot vehicle is required for width on two-lane highways on the unladen route.
4 Lane	Check None if no pilot vehicles are required for width, height, or overall length on any multilane highways on the unladen route. Check Front if a front pilot vehicle is required for width, height, or overall length on any multilane highways on the unladen route. Check Rear if a rear pilot vehicle is required for width on multilane highways on the unladen route.

Vehicle Information	
Do you know...?	<p>Choose Yes if you know the power unit plate and/or unit number. Key a plate or unit number, and click Add Vehicle.</p> <p>Choose No if you do not know the power unit plate and/or unit number. Either choose a range of unit numbers, or Show All Vehicles. Select a power unit from the list.</p> <p>One and only one power unit is allowed on self-issue permits. Use of Equipment List is not allowed on self-issue permits. Use of multiple vehicles or option of vehicles is not allowed on self-issue permits.</p>

Special Provisions	
Pilot Vehicle Requirements	Key specific pilot vehicle requirements, based on the overall length, width, and height of the permitted move. If the pilot vehicle requirements checked above apply to the entire route, key or check the box "See above for pilot vehicle requirements for entire route."

Special Provisions	
Road Restrictions	Key specific road, ramp, and/or bridge restrictions that apply to the permit, based on the route, overall length, width, weight, and height of the permitted move. If no road restrictions apply, key or check the box "No additional road restrictions required for this route at these dimensions."
Other Special Provisions	Key other special provisions, or check one (or more) of the boxes below. If no additional special provisions, key or check the box "No additional special provisions required for this permit."
** Either certified flaggers...	Check this box if the permittee is required to straddle the centerline or use the certified rolling method to safely cross through a structure, due to the height and/or width. The ** is used in the Route to specify the structure where traffic control is required. The Certified Flagger Attachment will automatically be added as a requirement. The 18 locations where this is allowed are shown on Route Map 2 .
** Certified flaggers...	Check this box if the permittee is required to straddle the centerline to safely cross through a structure, due to the height and/or width. The ** is used in the Route to specify the structure where traffic control is required. The Certified Flagger Attachment will automatically be added as a requirement.
Front pilot vehicle must be equipped...	This checkbox will appear if the load is more than 14 feet 06 inches in height, and the carrier does not have a height declaration on file. The box cannot be unchecked.

Final Details	
Location	<p>If TOL is chosen, the permit will only appear in the carrier's TOL reprint area. The carrier will need to log in to their TOL account to obtain the permit.</p> <p>If HOSTFAX is chosen, please provide a 10-digit fax number, or up to 4-digit INC code in the Hostfax Number field. In addition to the carrier's TOL reprint area, the permit will be sent to this fax number.</p>
Checkbox	The person issuing the permit must read the text, and check the box, if they agree.

S18 – Tow Vehicle

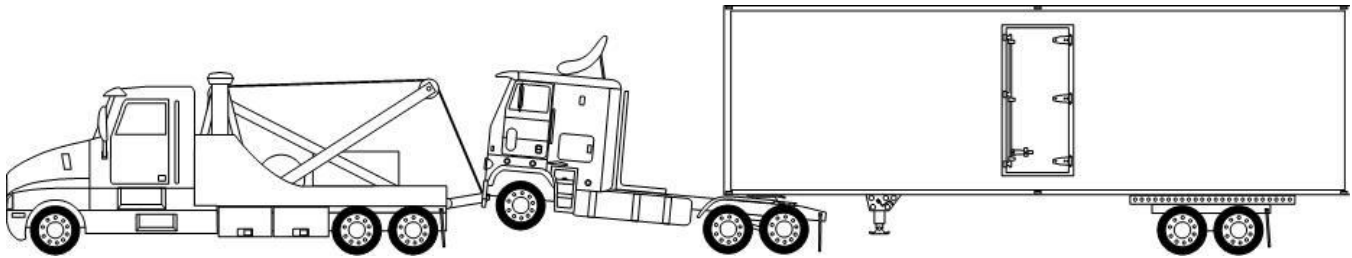

This permit class is intended for tow vehicles that are hauling or towing a wrecked or disabled vehicle or combination of vehicles. The permits can be issued before-the-fact, or after-the-fact.

Carrier Information Section	
Contact Name	First and last name of the person issuing the permit.
Phone Number	10-digit phone number of the person issuing the permit.
Email	When the self-issue permit is issued, an email will be sent to this email address, advising where to print it. The default email address is the email address assigned to the Oregon Trucking Online Account.
Permit Effective Date	The date that you want the self-issue permit to be effective. Self-issue permits are valid for up to 10 days, and must expire no more than 14 days from today's date.
Permit Expiration Date	The date that you want the self-issue permit to expire. Self-issue permits are valid for up to 10 days, and must expire no more than 14 days from today's date.

Non-Divisible Load Dimensions Section	
Commodity	The specific item being hauled or towed. Examples of <u>acceptable</u> entries include Disabled Vehicle or Disabled Combination
Load Length	The length of the vehicle or combination of vehicles being towed or hauled. The maximum load length for this class of self-issue permit is 120 feet.
Width	The total overall width of the load or hauling equipment, whichever is greater. Round fractions of an inch up to the next highest inch. Legal width in Oregon is 8 feet 06 inches. Enter 8'06" if the width is 8 feet 06 inches or less. Enter the actual width if the width is more than 8 feet 06 inches. Hauling a legal width load on an overwidth trailer is not allowed. The maximum width allowed in this class of self-issued permit is 10 feet 00 inches.

<p>Travel Height</p>	<p>The highest point of the load when prepared and ready for transport, as measured from the ground on a level surface. Round fractions of an inch up to the next highest inch. Legal height in Oregon is 14 feet 00 inches. Enter 14'00" if the height is 14 feet 00 inches or less. Enter the actual height if the height is more than 14 feet 00 inches.</p> <p>The maximum height allowed in this class of self-issued permit is 14 feet 06 inches.</p>
<p>Overall Length</p>	<p>Total length of the hauling equipment and the load, including any front and/or rear overhangs, rounded up to the nearest foot. Multiple items loaded end to end cannot overhang the back of the semitrailer length by more than 5 feet, subject to allowable overall lengths.</p> <p>An error message will appear if the following are keyed:</p> <ul style="list-style-type: none"> • The overall length is less than the load length. • The overall length is less than the trailer length. • If weights and spacings are provided, the overall length is less than the sum of the spacings. <p>The maximum load length for this class of self-issue permit is 120 feet.</p>
<p>Front Overhang</p>	<p>The distance that any part of the load extends beyond the forward most part of the body of the power unit. Legal front overhang is 4 feet 00 inches. Enter Legal if front overhang is 4 feet 00 inches or less. Enter the actual front overhang in feet when it exceeds 4 feet 00 inches, rounded up to the next highest foot.</p> <p>A load cannot have both excessive front and rear overhang at the same time.</p> <p>Refer to pilot vehicle table on Attachment 82A for pilots required for front overhang.</p> <p>Include language in special provisions "Load allowed to extend forward of the rear of the cab of the power unit" when the load on the semitrailer extends forward of the rear of the cab of the power unit.</p> <p>The maximum front overhang allowed in the Self-Issue Permits Program is 40 feet 00 inches.</p>

Rear Overhang	<p>Describes the rear extension of the load on a semitrailer.</p> <p>Items loaded end to end or overlapping are not allowed to extend more than 5 feet 00 inches beyond the rear of the semitrailer. Choose Legal if the distance from the back of the semitrailer to the end of the load measures 5 feet 00 inches or less.</p> <p>When the distance for a single, non-divisible item exceeds 5 feet 00 inches, rear overhang is measured from the center of the last axle of the semitrailer to the end of the load, and is subject to overall length limits. Wheelbase is the distance from the center of the first axle of the combination, to the center of the last axle of the combination.</p> <p>Choose 1/3WB if rear overhang is less than or equal to 1/3 of the overall wheelbase of the combination.</p> <p>Choose 1/2WB if rear overhang is more than 1/3, up to 1/2 of the overall wheelbase of the combination. The maximum rear overhang allowed in the Self-Issue Permits Program is 1/2 of the wheelbase, measured from the center of the last axle of the combination to the end of the load.</p> <p>Refer to Attachment 82A for flag and lighting requirements when a load extends off the rear of the semitrailer.</p>
Gross Weight	<p>Key the gross weight of the hauling equipment and load, in pounds. The maximum gross weight allowed in the Self-Issue Permits Program is 200,000 pounds.</p>
Description of Vehicles	<p>A description of the hauling equipment being used, i.e.: 4-3-2 for a 4-axle tow truck, towing a 3-axle truck and 2-axle semitrailer.</p>
Trailer Length	<p>The length of the semitrailer, when fully deployed for transport.</p> <p>Fixed trailers cannot exceed 62 feet in length in this class of self-issued permit. If flip axles(s) are deployed, a flip neck extension is deployed, or pinned axle(s) are added, the maximum trailer length is 65 feet.</p> <p>Stretch and Expanded trailers are allowed up to 65 feet in length.</p> <p>Special Use and Tow-away trailers allowed up to 65 feet in length.</p>
Trailer Type	<p>Choose Fixed if the trailer is not reducible in length.</p> <p>Choose Stretch if the trailer is a telescoping stretch trailer.</p> <p>Choose Expanded if the trailer length has been expanded with deck extensions.</p> <p>Choose Special Use if the trailer is built to haul one type of commodity only.</p> <p>Choose Tow-away if the equipment is permanently mounted to a trailer.</p> <p>Choose Float if the trailer is in float position, not directly hitched to the truck tractor.</p> <p>Choose None if no trailer is included in the combination.</p>

	<p>One of the following options may be selected for Fixed, Stretch, or Expanded trailers in excess of 53 feet in length:</p> <p>Choose Flip Axle(s) deployed if axles that can be flipped on the trailer are deployed to extend the hauling capacity of the trailer.</p> <p>Choose Flip Neck Extension if a gooseneck at the front of the trailer is flipped down, to adjust axle weights of the combination.</p> <p>Choose Pinned axle(s) if a separate vehicle is pinned to and does not pivot separately from the trailer, to add extra carrying capacity to the trailer.</p> <p>Both Flip Axle(s) deployed and Pinned axle(s) cannot be selected at the same time.</p> <p>These three options are not available for Special Use or Tow-away trailers.</p>
Additional Info	<p>If the Fixed, Stretch, or Expanded trailer length exceeds 53 feet, choose one of the reasons why the increased trailer length is required.</p> <p>Trailer length required to reduce height of the load.</p> <p>Trailer length required to support the load.</p> <p>Trailer length required to accommodate weight of the load.</p> <p>This option is not available for Special Use or Tow-away trailers.</p>
Weight Table	For this class of permit, Weight Table 1 , 3 or 4 are the only options.
Number of Axles	The number of axles on the ground. All available axles must be deployed when operating under a heavy haul permit.
Optionally, select a saved Weight Analysis...	If you have a weight analysis saved from the Calculate Oregon Weights application in the OD Menu of TOL, select it from the list. You will still need to key the Weight Table, Number of Axles, and Gross Weight.
List dimensions between axles...	This information is recommended for this class of self-issue permit when operating under Weight Table 3 or 4, and is used to calculate and confirm the appropriate weight table. If additional axle weight is required (as described in Attachment 76A), do not key axle spacings.
Group Axle Weights	This information is recommended for this class of self-issue permit when operating under Weight Table 3 or 4, and is used to calculate and confirm the appropriate weight table. If additional axle weight is required (as described in Attachment 76A), do not key axle spacings

Route Section	
Start Location	Choose Yes if the laden move will begin at an Oregon border location. Choose the border location from the list. Choose No if the laden move will begin in Oregon. Key the exact City, and Address, Cross Street, or Milepoint.
End Location	Choose Yes if the laden move will end at an Oregon border location. Choose the border location from the list. Choose No if the laden move will end in Oregon. Key the exact City, and Address, Cross Street, or Milepoint.

Route Section	
Route Description	Key the exact route, in order of travel. Include exit numbers where appropriate.

Move Information	
Is the move before the fact or after the fact?	Indicate if the permit is before the fact (you are obtaining the permit prior to operations) or after the fact (you are obtaining the permit after the move has been made, as allowed in OAR 734-076-0075(6c)).
Before the fact	Choose Before the fact if you are obtaining the permit prior to operations.
After the fact	Choose After the fact if you are obtaining the permit after the move has been made, as allowed in OAR 734-076-0075(6c). You will be required to key the date the move was made. If the gross weight exceeds 98,000 pounds, you will be required to key the number of miles traveled on Oregon highways.

Vehicle Information	
Do you know...?	<p>Choose Yes if you know the power unit plate and/or unit number. Key a plate or unit number, and click Add Vehicle.</p> <p>Choose No if you do not know the power unit plate and/or unit number. Either choose a range of unit numbers, or Show All Vehicles. Select a power unit from the list.</p> <p>One and only one power unit is allowed on self-issue permits. Use of Equipment List is not allowed on self-issue permits. Use of multiple vehicles or option of vehicles is not allowed on self-issue permits.</p>

Pilot Vehicle Section	
2 Lane	Check None if no pilot vehicles are required for width, height, or overall length on any two-lane highways on the route. Check Front if a front pilot vehicle is required for width, height, or overall length on any two-lane highways on the laden route. A rear pilot is never required on highways at the maximum dimensions allowed for this class of self-issued permit.
4 Lane	None is the default, as no pilot vehicles are required on multilane highways at the maximum dimensions allowed for this class of self-issued permit.

Special Provisions	
Pilot Vehicle Requirements	Key specific pilot vehicle requirements, based on the overall length, width, and height of the permitted move. If the pilot vehicle requirements checked above apply to the entire route, key or check the box "See above for pilot vehicle requirements for entire route."

Road Restrictions	Key specific road, ramp, and/or bridge restrictions that apply to the permit, based on the route, overall length, width, weight, and height of the permitted move. If no road restrictions apply, key or check the box "No additional road restrictions required for this route at these dimensions."
Other Special Provisions	Key other special provisions, or check one (or more) of the boxes below. If no additional special provisions, key or check the box "No additional special provisions required for this permit."
** Either certified flaggers...	Check this box if the permittee is required to straddle the centerline or use the certified rolling method to safely cross through a structure, due to the height and/or width. The ** is used in the Route to specify the structure where traffic control is required. The Certified Flagger Attachment will automatically be added as a requirement. The 18 locations where this is allowed are shown on Route Map 2 .
** Certified flaggers...	Check this box if the permittee is required to straddle the centerline to safely cross through a structure, due to the height and/or width. The ** is used in the Route to specify the structure where traffic control is required. The Certified Flagger Attachment will automatically be added as a requirement.

Final Details	
Location	<p>If TOL is chosen, the permit will only appear in the carrier's TOL reprint area. The carrier will need to log in to their TOL account to obtain the permit.</p> <p>If HOSTFAX is chosen, please provide a 10-digit fax number, or up to 4-digit INC code in the Hostfax Number field. In addition to the carrier's TOL reprint area, the permit will be sent to this fax number.</p>
Checkbox	The person issuing the person must read the text, and check the box, if they agree.

S30 – Truck Tractor/Semitrailer, Overlength

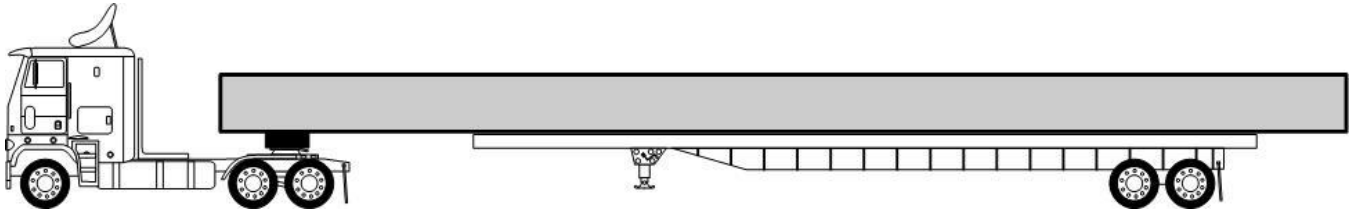

This permit class is intended for truck tractor/semitrailer combinations that are hauling an overlength load. All axles and group axle weights must be legal. Width and height must be legal.

Carrier Information Section	
Contact Name	First and last name of the person issuing the permit.
Phone Number	10-digit phone number of the person issuing the permit.
Email	When the self-issue permit is issued, an email will be sent to this email address, advising where to print it. The default email address is the email address assigned to the Oregon Trucking Online Account.
Permit Effective Date	The date that you want the self-issue permit to be effective. Self-issue permits are valid for up to 10 days, and must expire no more than 14 days from today's date.
Permit Expiration Date	The date that you want the self-issue permit to expire. Self-issue permits are valid for up to 10 days, and must expire no more than 14 days from today's date.

Non-Divisible Load Dimensions Section	
Commodity	The specific item being hauled. Examples of <u>acceptable</u> entries include poles or rebar
Load Length	If the load is 40 feet or less in length, enter 40. If the load is greater than 40 feet in length, enter the total load length rounded up to the next foot. The maximum load length for this class of self-issue permit is 120 feet.
Width	The maximum width allowed for this class of self-issued permit is 8 feet 6 inches. This cannot be edited.
Travel Height	The maximum height allowed for this class of self-issued permit is 14 feet 00 inches. This cannot be edited.

<p>Overall Length</p>	<p>Total length of the hauling equipment and the load, including any front and/or rear overhangs, rounded up to the nearest foot. Multiple items loaded end to end cannot overhang the back of the semitrailer by more than 5 feet, subject to allowable overall lengths.</p> <p>An error message will appear if the following are keyed:</p> <ul style="list-style-type: none"> • The overall length is less than the load length. • The overall length is less than the trailer length. • If weights and spacings are provided, the overall length is less than the sum of the spacings. <p>The maximum overall length allowed for this type of self-issued permit is 140 feet.</p>
<p>Front Overhang</p>	<p>The distance that any part of the load extends beyond the forward most part of the body of the power unit. Legal front overhang is 4 feet 00 inches or less. Legal is the default. Enter the actual front overhang in feet when it exceeds 4 feet 00 inches, rounded up to the next highest foot.</p> <p>A load cannot have both excessive front and rear overhang at the same time.</p> <p>Refer to pilot vehicle table on Attachment 82A for pilots required for front overhang.</p> <p>Include language in special provisions “Load allowed to extend forward of the rear of the cab of the power unit” when the load on the semitrailer extends forward of the rear of the cab of the power unit.</p> <p>The maximum front overhang allowed in the Self-Issue Permits Program is 40 feet 00 inches.</p>
<p>Rear Overhang</p>	<p>Items loaded end to end or overlapping are not allowed to extend more than 5 feet 00 inches beyond the rear of the semitrailer. Choose Legal if the distance from the back of the semitrailer to the end of the load measures 5 feet 00 inches or less.</p> <p>When the distance for a single, non-divisible item exceeds 5 feet 00 inches, rear overhang is measured from the center of the last axle of the semitrailer to the end of the load, and is subject to overall length limits. Wheelbase is the distance from the center of the first axle of the combination, to the center of the last axle of the combination.</p> <p>Choose 1/3WB if rear overhang is less than or equal to 1/3 of the overall wheelbase of the combination.</p> <p>Choose 1/2WB if rear overhang is more than 1/3, but up to 1/2 of the overall wheelbase of the combination. The maximum rear overhang allowed in the Self-Issue Permits Program is 1/2 of the wheelbase, measured from the center of the last axle of the combination to the end of the load.</p> <p>Refer to Attachment 82A for flag and lighting requirements when a load extends off the rear of the semitrailer.</p>

Gross Weight	For this class of self-issue permit, Legal (which is 80,000 pounds) is the default, and cannot be edited. The permit may be used in conjunction with a valid extended weight permit, issued to the power unit. See Special Provisions section for additional information.
Description of Vehicles	For this class of self-issue permit, Truck Tractor/Semitrailer is default, and cannot be edited.
Trailer Length	<p>The length of the semitrailer, when fully deployed for transport.</p> <p>Fixed trailers cannot exceed 53 feet in length. If flip axle(s) are deployed, a flip neck extension is deployed, or pinned axle(s) are added, the maximum trailer length is 65 feet. These trailers must be reduced to 53 feet or less in length when unladen, or a permitted unladen authorization is required.</p> <p>Stretch and Expanded trailers are allowed up to 65 feet in length. These trailers must be reduced to 53 feet or less in length when unladen, or a permitted unladen authorization is required.</p> <p>Special Use and Tow-away trailers are allowed up to 65 feet in length.</p>
Trailer Type	<p>Choose Fixed if the trailer is not reducible in length.</p> <p>Choose Stretch if the trailer is a telescoping stretch trailer.</p> <p>Choose Expanded if the trailer length has been expanded with deck extensions.</p> <p>Choose Special Use if the trailer is built to haul one type of commodity only.</p> <p>Choose Tow-away if the equipment is permanently mounted to a trailer.</p> <p>Choose Float if the trailer is in float position, not directly hitched to the truck tractor. The maximum trailer length allowed for float trailers is 53 feet.</p> <p>At least one of the following options must be selected if a fixed trailer exceeds 53 feet in length:</p> <p>Choose Flip Axles(s) deployed if axles that can be flipped on the trailer are deployed to extend the hauling capacity of the trailer.</p> <p>Choose Flip Neck Extension if a gooseneck at the front of the trailer is flipped down, to adjust axle weights of the combination.</p> <p>Choose Pinned axle(s) if a separate vehicle is pinned to and does not pivot separately from the trailer, to add extra carrying capacity to the trailer.</p> <p>Both Flip Axle(s) deployed and Pinned axle(s) cannot be selected at the same time.</p> <p>These three options are not available for Special Use or Tow-away trailers.</p> <p>These three options are available, but not required, for Stretch and Expanded trailer types.</p>

Additional Info	<p>If the Fixed, Stretch, or Expanded trailer length exceeds 53 feet, choose one of the reasons why the increased trailer length is required.</p> <ul style="list-style-type: none"> • Trailer length required to reduce height of the load. • Trailer length required to support the load. • Trailer length required to accommodate weight of the load. <p>This option is not available for Special Use or Tow-away trailers.</p>
Can the trailer be reduced...	<p>If the Fixed, Stretch, or Expanded trailer length exceeds 53 feet, indicate if the trailer can be reduced to 53 feet or less in length when unladen.</p> <p>If yes, a provision will be added to the permit, requiring the trailer to be reduced to 53 feet or less in length when unladen.</p> <p>If no, at least one unladen authorization is required for the excessive trailer length.</p> <p>This option is not available for Special Use or Tow-away trailers.</p>
Weight Table	<p>For this class of self-issue permit, Weight Table 1 is the only option, and cannot be edited. The permit may be used in conjunction with a valid extended weight permit, issued to the power unit. See Special Provisions section for additional information.</p>
Number of Axles	<p>The number of axles on the ground. This is not a required field for this permit class.</p>
List Dimensions Between Axles...	<p>This area is mainly used for heavy haul purposes, and is required for Weight Table 3 or 4 permits. This information is not required for this this class of permit.</p>
Group Axle Weights	<p>This area is mainly used for heavy haul purposes, and is required for Weight Table 3 or 4 permits. This information is not required for this this class of permit.</p>

Unladen Travel	
Unladen Travel Requested?	<p>Choose Yes if unladen authorization is required because the hauling equipment (trailer and/or overall length) is exceeding the legal length limits shown on Group Map 1 and Route Map 7.</p>
How many segments...?	<p>Up to two unladen segments are allowed on each single-trip permits. If the gross weight is in excess of 98,000 pounds. When unladen, a separate single-trip permit is required.</p>

Route Section	
Start Location	<p>Choose Yes if the laden move will begin at an Oregon border location. Choose the border location from the list. Choose No if the laden move will begin in Oregon. Key the exact City, and Address, Cross Street, or Milepoint.</p>

Route Section	
End Location	Choose Yes if the laden move will end at an Oregon border location. Choose the border location from the list. Choose No if the laden move will end in Oregon. Key the exact City, and Address, Cross Street, or Milepoint.
Route Description	Key the exact route, in order of travel. Include exit numbers where appropriate.

UNLADEN Load Dimensions Section	
Commodity	The default is Unladen Combination.
Load Length	The default is Legal .
Width	The total overall width of the hauling equipment.
Travel Height	The height of the hauling equipment as measured from a flat surface, ready for transport. Show the actual loaded height when operating greater than 14 feet 00 inches. Otherwise, indicate 14'00" .
Overall Length	The overall length of the hauling equipment.
Front Overhang	The default is Legal .
Rear Overhang	The default is Legal .
Gross Weight	For this class of self-issue permit, Legal (which is 80,000 pounds) is the default, and cannot be edited. The permit may be used in conjunction with a valid extended weight permit, issued to the power unit. See Special Provisions section for additional information.
Description of Vehicles	For this class of self-issue permit, Truck Tractor/Semitrailer is default, and cannot be edited.
Trailer Length	The length of the semitrailer, when fully deployed for transport. Fixed trailers cannot exceed 53 feet in length. If flip axle(s) are deployed, a flip neck extension is deployed, or pinned axle(s) are added, the maximum trailer length is 65 feet. Stretch and Expanded trailers are allowed up to 65 feet in length. Special Use and Tow-away trailers are allowed up to 65 feet in length.
Trailer Type	Choose Fixed if the trailer is not reducible in length. Choose Stretch if the trailer is a telescoping stretch trailer. Choose Expanded if the trailer length has been expanded with deck extensions. Choose Special Use if the trailer is built to haul one type of commodity only. Choose Tow-away if the equipment is permanently mounted to a trailer. At least one of the following options must be selected if a fixed trailer exceeds 53 feet in length:

	<p>Choose Flip Axles(s) deployed if axles that can be flipped on the trailer are deployed to extend the hauling capacity of the trailer.</p> <p>Choose Flip Neck Extension if a gooseneck at the front of the trailer is flipped down, to adjust axle weights of the combination.</p> <p>Choose Pinned axle(s) if a separate vehicle is pinned to and does not pivot separately from the trailer, to add extra carrying capacity to the trailer.</p> <p>Both Flip Axle(s) deployed and Pinned axle(s) cannot be selected at the same time.</p> <p>These three options are not available for Special Use or Tow-away trailers.</p> <p>These three options are available, but not required, for Stretch and Expanded trailer types.</p>
Weight Table	For this class of self-issue permit, Weight Table 1 is the only option, and cannot be edited. The permit may be used in conjunction with a valid extended weight permit, issued to the power unit. See Special Provisions section for additional information.
Number of Axles	The number of axles on the ground. This is not a required field for this permit class.
List dimensions between axles...	This area is mainly used for heavy haul purposes, and is required for Weight Table 3 or 4 permits. This information is not required for this this class of permit.
Group Axle Weights	This area is mainly used for heavy haul purposes, and is required for Weight Table 3 or 4 permits. This information is not required for this this class of permit.

UNLADEN Route(s) Section	
Start Location	Choose Yes if the unladen move will begin at an Oregon border location. Choose the border location from the list. Choose No if the unladen move will begin in Oregon. Key the exact City, and Address, Cross Street, or Milepoint.
End Location	Choose Yes if the unladen move will end at an Oregon border location. Choose the border location from the list. Choose No if the unladen move will end in Oregon. Key the exact City, and Address, Cross Street, or Milepoint.
Route Description	Key the exact route, in order of travel. Include exit numbers where appropriate.

UNLADEN Pilot Vehicle Section	
2 Lane	Check None if no pilot vehicles are required for width, height, or overall length on any two-lane highways on the unladen route. Check Front if a front pilot vehicle is required for width, height, or overall length on any two-lane highways on the unladen route. Check Rear if a rear pilot vehicle is required for width on two-lane highways on the unladen route.
4 Lane	Check None if no pilot vehicles are required for width, height, or overall length on any multilane highways on the unladen route. Check Front if a front pilot vehicle is required for width, height, or overall length on any multilane highways on the unladen route. Check Rear if a rear pilot vehicle is required for width on multilane highways on the unladen route.

Vehicle Information	
Do you know...?	<p>Choose Yes if you know the power unit plate and/or unit number. Key a plate or unit number, and click Add Vehicle.</p> <p>Choose No if you do not know the power unit plate and/or unit number. Either choose a range of unit numbers, or Show All Vehicles. Select a power unit from the list.</p> <p>One and only one power unit is allowed on self-issue permits. Use of Equipment List is not allowed on self-issue permits. Use of multiple vehicles or option of vehicles is not allowed on self-issue permits.</p>

Pilot Vehicle Section	
2 Lane	Check None if no pilot vehicles are required for width, height, or overall length on any two-lane highways on the laden route. Check Front if a front pilot vehicle is required for width, height, or overall length on any two-lane highways on the laden route. Check Rear if a rear pilot vehicle is required for width on any two-lane highways on the laden route.
4 Lane	Check None if no pilot vehicles are required for width, height, or overall length on any multilane highways on the laden route. Check Front if a front pilot vehicle is required for width, height, or overall length on any multilane highways on the laden route. Check Rear if a rear pilot vehicle is required for width or length on multilane highways on the laden route.

Special Provisions	
Pilot Vehicle Requirements	Key specific pilot vehicle requirements, based on the overall length, width, and height of the permitted move. If the pilot vehicle requirements checked above apply to the entire route, key or check the box "See above for pilot vehicle requirements for entire route."

Special Provisions	
Road Restrictions	Key specific road, ramp, and/or bridge restrictions that apply to the permit, based on the route, overall length, width, weight, and height of the permitted move. If no road restrictions apply, key or check the box "No additional road restrictions required for this route at these dimensions."
Other Special Provisions	Key other special provisions, or check one (or more) of the boxes below. If no additional special provisions, key or check the box "No additional special provisions required for this permit."
This permit may be used in conjunction...	Check this box if a valid extended weight permit has been issued to the truck, and the carrier will use this self-issue permit in conjunction with it.
** Either certified flaggers...	Check this box if the permittee is required to straddle the centerline or use the certified rolling method to safely cross through a structure, due to the height and/or width. The ** is used in the Route to specify the structure where traffic control is required. The Certified Flagger attachment will automatically be added as a requirement. The 18 locations where this is allowed are shown on Route Map 2 .
** Certified flaggers...	Check this box if the permittee is required to straddle the centerline to safely cross through a structure, due to the height and/or width. The ** is used in the Route to specify the structure where traffic control is required. The Certified Flagger Attachment will automatically be added as a requirement.
Front pilot vehicle must be equipped...	This checkbox will appear if the load is more than 14 feet 06 inches in height, and the carrier does not have a height declaration on file. The box cannot be unchecked.

Final Details	
Location	<p>If TOL is chosen, the permit will only appear in the carrier's TOL reprint area. The carrier will need to log in to their TOL account to obtain the permit.</p> <p>If HOSTFAX is chosen, please provide a 10-digit fax number, or up to 4-digit INC code in the Hostfax Number field. In addition to the carrier's TOL reprint area, the permit will be sent to this fax number.</p>
Checkbox	The person issuing the permit must read the text, and check the box, if they agree.

S35 – Self-Propelled Vehicle with Boom Dolly

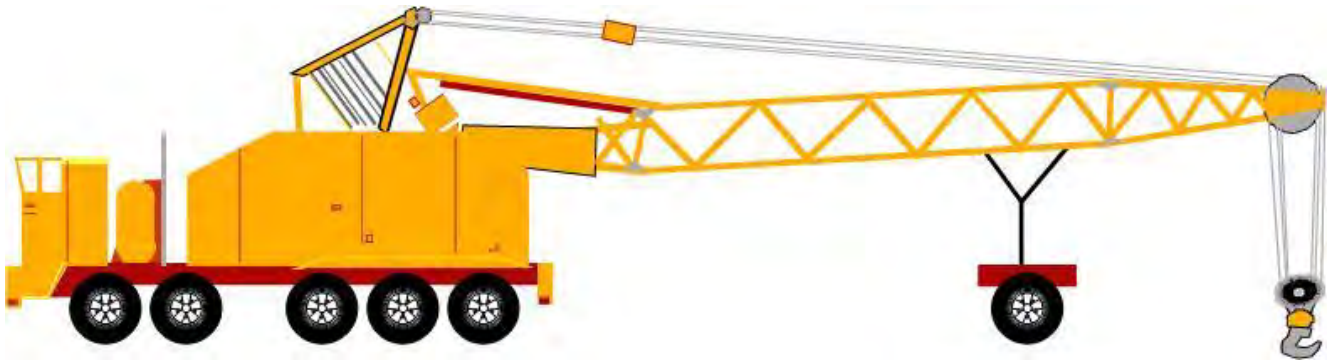

This permit class is intended for a self-propelled vehicle with boom dolly. Weights allowed up to Weight Table 4 and 200,000 pounds gross weight.

Carrier Information Section	
Contact Name	First and last name of the person issuing the permit.
Phone Number	10-digit phone number of the person issuing the permit.
Email	When the self-issue permit is issued, an email will be sent to this email address, advising where to print it. The default email address is the email address assigned to the Oregon Trucking Online Account.
Permit Effective Date	The date that you want the self-issue permit to be effective. Self-issue permits are valid for up to 10 days, and must expire no more than 14 days from today's date.
Permit Expiration Date	The date that you want the self-issue permit to expire. Self-issue permits are valid for up to 10 days, and must expire no more than 14 days from today's date.

Non-Divisible Load Dimensions Section	
Commodity	For this class of self-issue permit, Self-Propelled Vehicle with Boom Dolly is the default. This field is editable if, for example, the self-propelled vehicle is towing a pickup truck.
Load Length	The length of the vehicles and any front or rear overhangs. The load length must match the overall length. The maximum load length for this class of self-issue permit is 120 feet.
Width	The total overall width of the load or hauling equipment, whichever is greater. Round fractions of an inch up to the next highest inch. Legal width in Oregon is 8 feet 06 inches. Enter 8'06" if the width is 8 feet 06 inches or less. Enter the actual width if the width is more than 8 feet 06 inches. The maximum width allowed in the Self-Issue Permits Program is 14 feet 00 inches.

Travel Height	<p>The highest point of the load when prepared and ready for transport, as measured from the ground on a level surface. Round fractions of an inch up to the next highest inch. Legal height in Oregon is 14 feet 00 inches. Enter 14'00" if the height is 14 feet 00 inches or less. Enter the actual height if the height is more than 14 feet 00 inches.</p> <p>The maximum height allowed in the Self-Issue Permits Program is 15 feet 00 inches.</p>
Overall Length	<p>The length of the vehicles and any front or rear overhangs. The overall length must match the load length. The maximum overall length for this class of self-issue permit is 120 feet.</p>
Front Overhang	<p>The distance that any part of the load extends beyond the forward most part of the body of the power unit. Legal front overhang is 4 feet 00 inches. Enter Legal if front overhang is 4 feet 00 inches or less. Enter the actual front overhang in feet when it exceeds 4 feet 00 inches, rounded up to the next highest foot.</p> <p>A load cannot have both excessive front and rear overhang at the same time.</p> <p>Refer to pilot vehicle table on Attachment 82A for pilots required for front overhang.</p> <p>The maximum front overhang allowed in the Self-Issue Permits Program is 40 feet 00 inches.</p>
Rear Overhang	<p>The distance from the end of the dolly to the end of the load.</p> <p>Choose Legal if the distance from the back of the semitrailer to the end of the load measures 5 feet 00 inches or less.</p> <p>When the distance for a single, non-divisible item exceeds 5 feet 00 inches, rear overhang is measured from the center of the last axle of the semitrailer to the end of the load, and is subject to overall length limits. Wheelbase is the distance from the center of the first axle of the combination, to the center of the last axle of the combination.</p> <p>Choose 1/3WB if rear overhang is less than or equal to 1/3 of the overall wheelbase of the combination.</p> <p>Choose 1/2WB if rear overhang is more than 1/3, up to 1/2 of the overall wheelbase of the combination. The maximum rear overhang allowed in the Self-Issue Permits Program is 1/2 of the wheelbase, measured from the center of the last axle of the combination to the end of the load.</p> <p>Refer to Attachment 82A for flag and lighting requirements when a load extends off the rear of the semitrailer.</p>
Gross Weight	<p>Key the gross weight of the hauling equipment and load, in pounds. The maximum gross weight allowed in the Self-Issue Permits Program is 200,000 pounds.</p>
Description of Vehicles	<p>A description of the hauling equipment being used, i.e.: 5-D2 for a 5-axle self-propelled crane with 2-axle boom dolly.</p>

Weight Table	For this class of permit, Weight Table 1 , 3 or 4 are the only options. When operating under Weight Table 3 or 4, the weight table chosen must match the weight table calculated by the weights and spacings provided below.
Number of Axles	The number of axles on the ground. All available axles must be deployed when operating under a heavy haul permit.
Optionally, select a saved Weight Analysis...	If you have a weight analysis saved from the Calculate Oregon Weights application in the OD Menu of TOL, select it from the list. You will still need to key the Weight Table, Number of Axles, and Gross Weight.
List dimensions between axles...	This information is required for this class of self-issue permit when operating under Weight Table 3 or 4, and is used to calculate and confirm the appropriate weight table.
Group Axle Weights	This information is required for this class of self-issue permit when operating under Weight Table 3 or 4, and is used to calculate and confirm the appropriate weight table.

Route Section	
Start Location	Choose Yes if the laden move will begin at an Oregon border location. Choose the border location from the list. Choose No if the laden move will begin in Oregon. Key the exact City, and Address, Cross Street, or Milepoint.
End Location	Choose Yes if the laden move will end at an Oregon border location. Choose the border location from the list. Choose No if the laden move will end in Oregon. Key the exact City, and Address, Cross Street, or Milepoint.
Route Description	Key the exact route, in order of travel. Include exit numbers where appropriate.

Pilot Vehicle Section	
2 Lane	Check None if no pilot vehicles are required for width, height, or overall length on any two-lane highways on the laden route. Check Front if a front pilot vehicle is required for width, height, or overall length on any two-lane highways on the laden route. Check Rear if a rear pilot vehicle is required for width on any two-lane highways on the laden route.
4 Lane	Check None if no pilot vehicles are required for width, height, or overall length on any multilane highways on the laden route. Check Front if a front pilot vehicle is required for width, height, or overall length on any multilane highways on the laden route. Check Rear if a rear pilot vehicle is required for width or length on multilane highways on the laden route.

Vehicle Information	
Do you know...?	<p>Choose Yes if you know the power unit plate and/or unit number. Key a plate or unit number, and click Add Vehicle.</p> <p>Choose No if you do not know the power unit plate and/or unit number. Either choose a range of unit numbers, or Show All Vehicles. Select a power unit from the list.</p> <p>One and only one power unit is allowed on self-issue permits. Use of Equipment List is not allowed on self-issue permits. Use of multiple vehicles or option of vehicles is not allowed on self-issue permits.</p>

Special Provisions	
Pilot Vehicle Requirements	Key specific pilot vehicle requirements, based on the overall length, width, and height of the permitted move. If the pilot vehicle requirements checked above apply to the entire route, key or check the box "See above for pilot vehicle requirements for entire route."
Road Restrictions	Key specific road, ramp, and/or bridge restrictions that apply to the permit, based on the route, overall length, width, weight, and height of the permitted move. If no road restrictions apply, key or check the box "No additional road restrictions required for this route at these dimensions."
Other Special Provisions	Key other special provisions, or check one (or more) of the boxes below. If no additional special provisions, key or check the box "No additional special provisions required for this permit."
** Either certified flaggers...	Check this box if the permittee is required to straddle the centerline or use the certified rolling method to safely cross through a structure, due to the height and/or width. The ** is used in the Route to specify the structure where traffic control is required. The Certified Flagger Attachment will automatically be added as a requirement. The 18 locations where this is allowed are shown on Route Map 2 .
** Certified flaggers...	Check this box if the permittee is required to straddle the centerline to safely cross through a structure, due to the height and/or width. The ** is used in the Route to specify the structure where traffic control is required. The Certified Flagger Attachment will automatically be added as a requirement.
Front pilot vehicle must be equipped...	This checkbox will appear if the load is more than 14 feet 06 inches in height, and the carrier does not have a height declaration on file. The box cannot be unchecked.

Final Details	
Location	<p>If TOL is chosen, the permit will only appear in the carrier's TOL reprint area. The carrier will need to log in to their TOL account to obtain the permit.</p> <p>If HOSTFAX is chosen, please provide a 10-digit fax number, or up to 4-digit INC code in the Hostfax Number field. In addition to the carrier's TOL reprint area, the permit will be sent to this fax number.</p>
Checkbox	The person issuing the permit must read the text, and check the box, if they agree.

S37 – Self-Propelled Vehicle - Weight Table 3



This permit class is intended self-propelled vehicles that are operating with heavy haul axle and/or group axle weights, up to Weight Table 3 and 200,000 pounds gross weight.

Carrier Information Section	
Contact Name	First and last name of the person issuing the permit.
Phone Number	10-digit phone number of the person issuing the permit.
Email	When the self-issue permit is issued, an email will be sent to this email address, advising where to print it. The default email address is the email address assigned to the Oregon Trucking Online Account.
Permit Effective Date	The date that you want the self-issue permit to be effective. Self-issue permits are valid for up to 10 days, and must expire no more than 14 days from today's date.
Permit Expiration Date	The date that you want the self-issue permit to expire. Self-issue permits are valid for up to 10 days, and must expire no more than 14 days from today's date.

Non-Divisible Load Dimensions Section	
Commodity	For this class of self-issue permit, Self-Propelled Vehicle is the default, and cannot be edited.
Load Length	The length of the vehicles and any front or rear overhangs. The load length must match the overall length. The maximum load length for this class of self-issue permit is 55 feet.
Width	<p>The total overall width of the load or hauling equipment, whichever is greater. Round fractions of an inch up to the next highest inch. Legal width in Oregon is 8 feet 06 inches. Enter 8'06" if the width is 8 feet 06 inches or less. Enter the actual width if the width is more than 8 feet 06 inches.</p> <p>The maximum width allowed in the Self-Issue Permits Program is 14 feet 00 inches.</p>

Travel Height	<p>The highest point of the load when prepared and ready for transport, as measured from the ground on a level surface. Round fractions of an inch up to the next highest inch. Legal height in Oregon is 14 feet 00 inches. Enter 14'00" if the height is 14 feet 00 inches or less. Enter the actual height if the height is more than 14 feet 00 inches.</p> <p>The maximum height allowed in the Self-Issue Permits Program is 15 feet 00 inches.</p>
Overall Length	<p>The length of the vehicles and any front or rear overhangs. The overall length must match the load length. The maximum overall length for this class of self-issue permit is 55 feet.</p>
Front Overhang	<p>The distance that any part of the load extends beyond the forward most part of the body of the power unit. Legal front overhang is 4 feet 00 inches. Enter Legal if front overhang is 4 feet 00 inches or less. Enter the actual front overhang in feet when it exceeds 4 feet 00 inches, rounded up to the next highest foot.</p> <p>A load cannot have both excessive front and rear overhang at the same time.</p> <p>Refer to pilot vehicle table on Attachment 82A for pilots required for front overhang.</p> <p>The maximum front overhang allowed in the Self-Issue Permits Program is 40 feet 00 inches.</p>
Rear Overhang	<p>The distance from the center of the last axle to the end of the load. Choose 3/4WB if rear overhang is less than or equal to 3/4 of the overall wheelbase of the combination.</p> <p>Choose 100WB if rear overhang is more than 3/4, up to 100% of the overall wheelbase of the combination. The maximum rear overhang allowed in this class of Self-Issue Permits Program is 100% of the wheelbase, measured from the center of the last axle of the vehicle to the end of the load.</p> <p>Refer to Attachment 82A for flag and lighting requirements when a load extends off the rear of the semitrailer.</p>
Gross Weight	<p>Key the gross weight of the hauling equipment and load, in pounds. The maximum gross weight allowed in the Self-Issue Permits Program is 200,000 pounds.</p>
Description of Vehicles	<p>A description of the hauling equipment being used, i.e.: 5-axle self-propelled vehicle for a 5-axle self-propelled crane.</p>
Weight Table	<p>For this class of permit, Weight Table 3 is the only option. This must match the weight table calculated by the weights and spacings provided below.</p>
Optionally, select a saved Weight Analysis...	<p>If you have a weight analysis saved from the Calculate Oregon Weights application in the OD Menu of TOL, select it from the list. You will still need to key the Weight Table, Number of Axles, and Gross Weight.</p>
Number of Axles	<p>The number of axles on the ground. All available axles must be deployed when operating under a heavy haul permit.</p>

List dimensions between axles...	This information is required for this class of self-issue permit, and is used to calculate and confirm Weight Table 3 group axle weights.
Group Axle Weights	This information is required for this class of self-issue permit, and is used to calculate and confirm Weight Table 3 group axle weights.

Route Section	
Start Location	Choose Yes if the laden move will begin at an Oregon border location. Choose the border location from the list. Choose No if the laden move will begin in Oregon. Key the exact City, and Address, Cross Street, or Milepoint.
End Location	Choose Yes if the laden move will end at an Oregon border location. Choose the border location from the list. Choose No if the laden move will end in Oregon. Key the exact City, and Address, Cross Street, or Milepoint.
Route Description	Key the exact route, in order of travel. Include exit numbers where appropriate.

Pilot Vehicle Section	
2 Lane	Check None if no pilot vehicles are required for width, height, or overall length on any two-lane highways on the laden route. Check Front if a front pilot vehicle is required for width, height, or overall length on any two-lane highways on the laden route. Check Rear if a rear pilot vehicle is required for width on any two-lane highways on the laden route.
4 Lane	Check None if no pilot vehicles are required for width, height, or overall length on any multilane highways on the laden route. Check Front if a front pilot vehicle is required for width, height, or overall length on any multilane highways on the laden route. Check Rear if a rear pilot vehicle is required for width or length on multilane highways on the laden route.

Vehicle Information	
Do you know...?	<p>Choose Yes if you know the power unit plate and/or unit number. Key a plate or unit number, and click Add Vehicle.</p> <p>Choose No if you do not know the power unit plate and/or unit number. Either choose a range of unit numbers, or Show All Vehicles. Select a power unit from the list.</p> <p>One and only one power unit is allowed on self-issue permits. Use of Equipment List is not allowed on self-issue permits. Use of multiple vehicles or option of vehicles is not allowed on self-issue permits.</p>

Special Provisions	
Pilot Vehicle Requirements	Key specific pilot vehicle requirements, based on the overall length, width, and height of the permitted move. If the pilot vehicle requirements checked above apply to the entire route, key or check the box "See above for pilot vehicle requirements for entire route."
Road Restrictions	Key specific road, ramp, and/or bridge restrictions that apply to the permit, based on the route, overall length, width, weight, and height of the permitted move. If no road restrictions apply, key or check the box "No additional road restrictions required for this route at these dimensions."
Other Special Provisions	Key other special provisions, or check one (or more) of the boxes below. If no additional special provisions, key or check the box "No additional special provisions required for this permit."
** Either certified flaggers...	Check this box if the permittee is required to straddle the centerline or use the certified rolling method to safely cross through a structure, due to the height and/or width. The ** is used in the Route to specify the structure where traffic control is required. The Certified Flagger Attachment will automatically be added as a requirement. The 18 locations where this is allowed are shown on Route Map 2 .
** Certified flaggers...	Check this box if the permittee is required to straddle the centerline to safely cross through a structure, due to the height and/or width. The ** is used in the Route to specify the structure where traffic control is required. The Certified Flagger Attachment will automatically be added as a requirement.
Front pilot vehicle must be equipped...	This checkbox will appear if the load is more than 14 feet 06 inches in height, and the carrier does not have a height declaration on file. The box cannot be unchecked.

Final Details	
Location	<p>If TOL is chosen, the permit will only appear in the carrier's TOL reprint area. The carrier will need to log in to their TOL account to obtain the permit.</p> <p>If HOSTFAX is chosen, please provide a 10-digit fax number, or up to 4-digit INC code in the Hostfax Number field. In addition to the carrier's TOL reprint area, the permit will be sent to this fax number.</p>
Checkbox	<p>The person issuing the permit must read the text, and check the box, if they agree.</p>

S38 – Self-Propelled Vehicle - Weight Table 4



This permit class is intended for self-propelled vehicles that are operating with heavy haul axle and/or group axle weights, up to [Weight Table 4](#) and 200,000 pounds gross weight.

Carrier Information Section	
Contact Name	First and last name of the person issuing the permit.
Phone Number	10-digit phone number of the person issuing the permit.
Email	When the self-issue permit is issued, an email will be sent to this email address, advising where to print it. The default email address is the email address assigned to the Oregon Trucking Online Account.
Permit Effective Date	The date that you want the self-issue permit to be effective. Self-issue permits are valid for up to 10 days, and must expire no more than 14 days from today's date.
Permit Expiration Date	The date that you want the self-issue permit to expire. Self-issue permits are valid for up to 10 days, and must expire no more than 14 days from today's date.

Non-Divisible Load Dimensions Section	
Commodity	For this class of self-issue permit, Self-Propelled Vehicle is the default, and cannot be edited.
Load Length	The length of the vehicles and any front or rear overhangs. The load length must match the overall length. The maximum load length for this class of self-issue permit is 55 feet.
Width	<p>The total overall width of the load or hauling equipment, whichever is greater. Round fractions of an inch up to the next highest inch. Legal width in Oregon is 8' feet 06 inches. Enter 8'06" if the width is 8 feet 06 inches or less. Enter the actual width if the width is more than 8 feet 06 inches.</p> <p>The maximum width allowed in the Self-Issue Permits Program is 14 feet 00 inches.</p>

Travel Height	<p>The highest point of the load when prepared and ready for transport, as measured from the ground on a level surface. Round fractions of an inch up to the next highest inch. Legal height in Oregon is 14 feet 00 inches. Enter 14'00" if the height is 14 feet 00 inches or less. Enter the actual height if the height is more than 14 feet 00 inches.</p> <p>The maximum height allowed in the Self-Issue Permits Program is 15 feet 00 inches.</p>
Overall Length	<p>The length of the vehicles and any front or rear overhangs. The overall length must match the load length. The maximum overall length for this class of self-issue permit is 55 feet.</p>
Front Overhang	<p>The distance that any part of the load extends beyond the forward most part of the body of the power unit. Legal front overhang is 4 feet 00 inches. Enter Legal if front overhang is 4 feet 00 inches or less. Enter the actual front overhang in feet when it exceeds 4 feet 00 inches, rounded up to the next highest foot.</p> <p>A load cannot have both excessive front and rear overhang at the same time.</p> <p>Refer to pilot vehicle table on Attachment 82A for pilots required for front overhang.</p> <p>The maximum front overhang allowed in the Self-Issue Permits Program is 40 feet 00 inches.</p>
Rear Overhang	<p>The distance from the center of the last axle to the end of the load.</p> <p>Choose 3/4WB if rear overhang is less than or equal to 3/4 of the overall wheelbase of the combination.</p> <p>Choose 100WB if rear overhang is more than 3/4, up to 100% of the overall wheelbase of the combination. The maximum rear overhang allowed in this class of Self-Issue Permits Program is 100% of the wheelbase, measured from the center of the last axle of the vehicle to the end of the load.</p> <p>Refer to Attachment 82A for flag and lighting requirements when a load extends off the rear of the semitrailer.</p>
Gross Weight	<p>Key the gross weight of the hauling equipment and load, in pounds. The maximum gross weight allowed in the Self-Issue Permits Program is 200,000 pounds.</p>
Description of Vehicles	<p>A description of the hauling equipment being used, i.e.: 5-axle self-propelled vehicle for a 5-axle self-propelled crane.</p>
Weight Table	<p>For this class of permit, Weight Table 4 is the only option. This must match the weight table calculated by the weights and spacings provided below.</p>
Number of Axles	<p>The number of axles on the ground. All available axles must be deployed when operating under a heavy haul permit.</p>
Optionally, select a saved Weight Analysis...	<p>If you have a weight analysis saved from the Calculate Oregon Weights application in the OD Menu of TOL, select it from the list. You will still need to key the Weight Table, Number of Axles, and Gross Weight.</p>

List dimensions between axles...	This information is required for this class of self-issue permit, and is used to calculate and confirm Weight Table 4 group axle weights.
Group Axle Weights	This information is required for this class of self-issue permit, and is used to calculate and confirm Weight Table 4 group axle weights.

Route Section	
Start Location	Choose Yes if the laden move will begin at an Oregon border location. Choose the border location from the list. Choose No if the laden move will begin in Oregon. Key the exact City, and Address, Cross Street, or Milepoint.
End Location	Choose Yes if the laden move will end at an Oregon border location. Choose the border location from the list. Choose No if the laden move will end in Oregon. Key the exact City, and Address, Cross Street, or Milepoint.
Route Description	Key the exact route, in order of travel. Include exit numbers where appropriate.

Pilot Vehicle Section	
2 Lane	Check None if no pilot vehicles are required for width, height, or overall length on any two-lane highways on the laden route. Check Front if a front pilot vehicle is required for width, height, or overall length on any two-lane highways on the laden route. Check Rear if a rear pilot vehicle is required for width on any two-lane highways on the laden route.
4 Lane	Check None if no pilot vehicles are required for width, height, or overall length on any multilane highways on the laden route. Check Front if a front pilot vehicle is required for width, height, or overall length on any multilane highways on the laden route. Check Rear if a rear pilot vehicle is required for width or length on multilane highways on the laden route.

Vehicle Information	
Do you know...?	<p>Choose Yes if you know the power unit plate and/or unit number. Key a plate or unit number, and click Add Vehicle.</p> <p>Choose No if you do not know the power unit plate and/or unit number. Either choose a range of unit numbers, or Show All Vehicles. Select a power unit from the list.</p> <p>One and only one power unit is allowed on self-issue permits. Use of Equipment List is not allowed on self-issue permits. Use of multiple vehicles or option of vehicles is not allowed on self-issue permits.</p>

Special Provisions	
Pilot Vehicle Requirements	Key specific pilot vehicle requirements, based on the overall length, width, and height of the permitted move. If the pilot vehicle requirements checked above apply to the entire route, key or check the box "See above for pilot vehicle requirements for entire route."
Road Restrictions	Key specific road, ramp, and/or bridge restrictions that apply to the permit, based on the route, overall length, width, weight, and height of the permitted move. If no road restrictions apply, key or check the box "No additional road restrictions required for this route at these dimensions."
Other Special Provisions	Key other special provisions, or check one (or more) of the boxes below. If no additional special provisions, key or check the box "No additional special provisions required for this permit."
** Either certified flaggers...	Check this box if the permittee is required to straddle the centerline or use the certified rolling method to safely cross through a structure, due to the height and/or width. The ** is used in the Route to specify the structure where traffic control is required. The Certified Flagger Attachment will automatically be added as a requirement. The 18 locations where this is allowed are shown on Route Map 2 .
** Certified flaggers...	Check this box if the permittee is required to straddle the centerline to safely cross through a structure, due to the height and/or width. The ** is used in the Route to specify the structure where traffic control is required. The Certified Flagger Attachment will automatically be added as a requirement.
Front pilot vehicle must be equipped...	This checkbox will appear if the load is more than 14 feet 06 inches in height, and the carrier does not have a height declaration on file. The box cannot be unchecked.

Final Details	
Location	<p>If TOL is chosen, the permit will only appear in the carrier's TOL reprint area. The carrier will need to log in to their TOL account to obtain the permit.</p> <p>If HOSTFAX is chosen, please provide a 10-digit fax number, or up to 4-digit INC code in the Hostfax Number field. In addition to the carrier's TOL reprint area, the permit will be sent to this fax number.</p>
Checkbox	The person issuing the person must read the text, and check the box, if they agree.

S39 – Heavy Haul Combinations

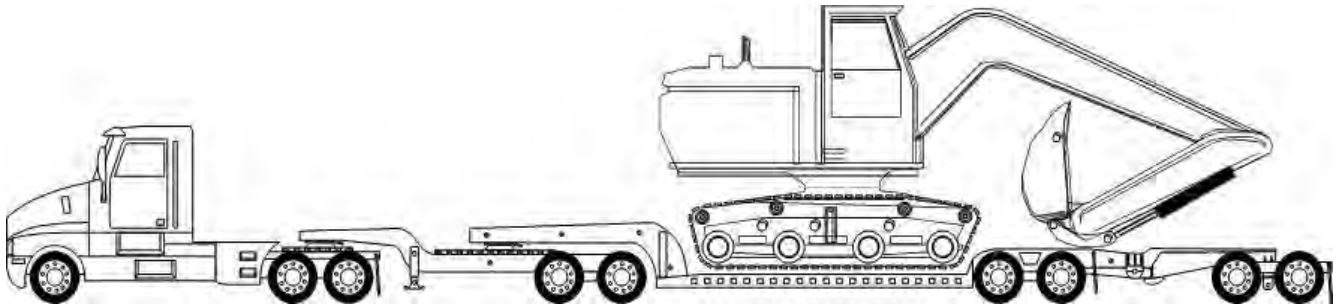

This permit class is intended for heavy haul combinations (typically, a combination that includes a truck-tractor, semitrailer, jeep axle(s), booster axle(s), dolly axle(s), etc.) and are operating with heavy haul axle and/or group axle weights, up to [Weight Table 4](#) and 200,000 pounds gross weight.

Carrier Information Section	
Contact Name	First and last name of the person issuing the permit.
Phone Number	10-digit phone number of the person issuing the permit.
Email	When the self-issue permit is issued, an email will be sent to this email address, advising where to print it. The default email address is the email address assigned to the Oregon Trucking Online Account.
Permit Effective Date	The date that you want the self-issue permit to be effective. Self-issue permits are valid for up to 10 days, and must expire no more than 14 days from today's date.
Permit Expiration Date	The date that you want the self-issue permit to expire. Self-issue permits are valid for up to 10 days, and must expire no more than 14 days from today's date.

Non-Divisible Load Dimensions Section	
Commodity	The specific item being hauled. Examples of <u>acceptable</u> entries include Backhoe, D6 Dozer With Blade, or Air Handling Unit. Examples of <u>unacceptable</u> entries include Construction Equipment, Machinery, HVAC Parts, and Building Materials.
Load Length	If the load is 40 feet or less in length, enter 40 . If the load is greater than 40 feet in length, enter the total load length rounded up to the next foot. The maximum load length for this class of self-issue permit is 120 feet.
Width	The total overall width of the load or hauling equipment, whichever is greater. Round fractions of an inch up to the next highest inch. Legal width in Oregon is 8 feet 06 inches. Enter 8'06" if the width is 8 feet 06 inches or less. Enter the actual width if the width is more than 8 feet 06 inches. Hauling a legal width load on an overwidth trailer is not allowed. The maximum width allowed in the Self-Issue Permits Program is 14 feet 00 inches.

<p>Travel Height</p>	<p>The highest point of the load when prepared and ready for transport, as measured from the ground on a level surface. Round fractions of an inch up to the next highest inch. Legal height in Oregon is 14 feet 00 inches. Enter 14'00" if the height is 14 feet 00 inches or less. Enter the actual height if the height is more than 14 feet 00 inches.</p> <p>The maximum height allowed in the Self-Issue Permits Program is 15 feet 00 inches.</p>
<p>Overall Length</p>	<p>Total length of the hauling equipment and the load, including any front and/or rear overhangs, rounded up to the nearest foot. Multiple items loaded end to end cannot overhang the back of the semitrailer length by more than 5 feet, subject to allowable overall lengths.</p> <p>An error message will appear if the following are keyed:</p> <ul style="list-style-type: none"> • The overall length is less than the load length. • The overall length is less than the trailer length. • If weights and spacings are provided, the overall length is less than the sum of the spacings. <p>The maximum overall length allowed in the Self-Issue Permits Program for a heavy haul combinations (including jeeps, boosters, dollies, etc.) is 120 feet.</p>
<p>Front Overhang</p>	<p>The distance that any part of the load extends beyond the forward most part of the body of the power unit. Legal front overhang is 4 feet 00 inches. Enter Legal if front overhang is 4 feet 00 inches or less. Enter the actual front overhang in feet when it exceeds 4 feet 00 inches, rounded up to the next highest foot.</p> <p>A load cannot have both excessive front and rear overhang at the same time.</p> <p>Refer to pilot vehicle table on Attachment 82A for pilots required for front overhang.</p> <p>Include language in special provisions "Load allowed to extend forward of the rear of the cab of the power unit" when the load on the semitrailer extends forward of the rear of the cab of the power unit.</p> <p>The maximum front overhang allowed in the Self-Issue Permits Program is 40 feet 00 inches.</p>

Rear Overhang	<p>Describes the rear extension of the load on a semitrailer.</p> <p>Items loaded end to end or overlapping are not allowed to extend more than 5 feet 00 inches beyond the rear of the semitrailer. Choose Legal if the distance from the back of the semitrailer to the end of the load measures 5 feet 00 inches or less.</p> <p>When the distance for a single, non-divisible item exceeds 5 feet 00 inches, rear overhang is measured from the center of the last axle of the semitrailer to the end of the load, and is subject to overall length limits. Wheelbase is the distance from the center of the first axle of the combination, to the center of the last axle of the combination.</p> <p>Choose 1/3WB if rear overhang is less than or equal to 1/3 of the overall wheelbase of the combination.</p> <p>Choose 1/2WB if rear overhang is more than 1/3, up to 1/2 of the overall wheelbase of the combination. The maximum rear overhang allowed in the Self-Issue Permits Program is 1/2 of the wheelbase, measured from the center of the last axle of the combination to the end of the load.</p> <p>Refer to Attachment 82A for flag and lighting requirements when a load extends off the rear of the semitrailer.</p>
Gross Weight	<p>Key the gross weight of the hauling equipment and load, in pounds. The maximum gross weight allowed in the Self-Issue Permits Program is 200,000 pounds.</p>
Description of Vehicles	<p>A description of the hauling equipment being used, i.e.: 3-J2-S2-B2 for a 3-axle truck-tractor with a 2-axle jeep, 2-axle semitrailer, and 2-axle booster. For this class of self-issue permit, a heavy haul combination (including jeeps, boosters, dollies, etc.) is required.</p>
Trailer Length	<p>The length of the semitrailer, when fully deployed for transport.</p> <p>Fixed trailers cannot exceed 62 feet in length in this class of self-issued permit. If flip axle(s) are deployed, a flip neck extension is deployed, or pinned axle(s) are added, the maximum trailer length is 65 feet.</p> <p>Stretch and Expanded trailers are allowed up to 65 feet in length.</p> <p>Special Use and Tow-away trailers allowed up to 65 feet in length.</p>
Trailer Type	<p>Choose Fixed if the trailer is not reducible in length.</p> <p>Choose Stretch if the trailer is a telescoping stretch trailer.</p> <p>Choose Expanded if the trailer length has been expanded with deck extensions.</p> <p>Choose Special Use if the trailer is built to haul one type of commodity only.</p> <p>Choose Tow-away if the equipment is permanently mounted to a trailer.</p>

	<p>One of the following options may be selected for Fixed, Stretch, or Expanded trailers in excess of 53 feet in length:</p> <p>Choose Flip Axles(s) deployed if axles that can be flipped on the trailer are deployed to extend the hauling capacity of the trailer.</p> <p>Choose Flip Neck Extension if a gooseneck at the front of the trailer is flipped down, to adjust axle weights of the combination.</p> <p>Choose Pinned axle(s) if a separate vehicle is pinned to and does not pivot separately from the trailer, to add extra carrying capacity to the trailer.</p> <p>Both Flip Axle(s) deployed and Pinned axle(s) cannot be selected at the same time.</p> <p>These three options are not available for Special Use or Tow-away trailers.</p>
Additional Info	<p>If the Fixed, Stretch, or Expanded trailer length exceeds 53 feet, choose one of the reasons why the increased trailer length is required.</p> <ul style="list-style-type: none"> • Trailer length required to reduce height of the load. • Trailer length required to support the load. • Trailer length required to accommodate weight of the load. <p>If Special Use is selected, indicate that the special use trailer is designed to haul only the commodity permitted.</p> <p>This option is not available for Tow-away trailers.</p>
Weight Table	<p>For this class of permit, Weight Table 1, 3 or 4 are the only options. When operating under Weight Table 3 or 4, the weight table chosen must match the weight table calculated by the weights and spacings provided below.</p>
Number of Axles	<p>The number of axles on the ground. All available axles must be deployed when operating under a heavy haul permit.</p>
Optionally, select a saved Weight Analysis...	<p>If you have a weight analysis saved from the Calculate Oregon Weights application in the OD Menu of TOL, select it from the list. You will still need to key the Weight Table, Number of Axles, and Gross Weight.</p>
List dimensions between axles...	<p>This information is required for this class of self-issue permit when operating under Weight Table 3 or 4, and is used to calculate and confirm the appropriate weight table.</p>
Group Axle Weights	<p>This information is required for this class of self-issue permit when operating under Weight Table 3 or 4, and is used to calculate and confirm the appropriate weight table.</p>

Unladen Travel	
Unladen Travel Requested?	<p>Choose Yes if unladen authorization is required because the hauling equipment is exceeding the routes and dimensions allowed on the carrier's annual unladen heavy haul permit.</p>

Unladen Travel	
How many segments...?	Up to two unladen segments are allowed on each single-trip permits. If the gross weight is in excess of 98,000 pounds when unladen, a separate single-trip permit is required.

Route Section	
Start Location	Choose Yes if the laden move will begin at an Oregon border location. Choose the border location from the list. Choose No if the laden move will begin in Oregon. Key the exact City, and Address, Cross Street, or Milepoint.
End Location	Choose Yes if the laden move will end at an Oregon border location. Choose the border location from the list. Choose No if the laden move will end in Oregon. Key the exact City, and Address, Cross Street, or Milepoint.
Route Description	Key the exact route, in order of travel. Include exit numbers where appropriate.

Pilot Vehicle Section	
2 Lane	Check None if no pilot vehicles are required for width, height, or overall length on any two-lane highways on the laden route. Check Front if a front pilot vehicle is required for width, height, or overall length on any two-lane highways on the laden route. Check Rear if a rear pilot vehicle is required for width on any two-lane highways on the laden route.
4 Lane	Check None if no pilot vehicles are required for width, height, or overall length on any multilane highways on the laden route. Check Front if a front pilot vehicle is required for width, height, or overall length on any multilane highways on the laden route. Check Rear if a rear pilot vehicle is required for width or length on multilane highways on the laden route.

UNLADEN Load Dimensions Section	
Commodity	The default is Unladen Combination.
Load Length	The default is Legal .
Width	The total overall width of the hauling equipment.
Travel Height	The height of the hauling equipment as measured from a flat surface, ready for transport. Show the actual loaded height when operating greater than 14 feet. Otherwise, indicate 14'00" .
Overall Length	The overall length of the hauling equipment.
Front Overhang	The default is Legal .
Rear Overhang	The default is Legal .

Gross Weight	The default is Legal . The maximum gross weight for an unladen section of a single-trip permit is 98,000 pounds.
Description of Vehicles	A description of the hauling equipment being used, i.e.: 3-J2-S2-B2 for a 3-axle truck-tractor with a 2-axle jeep, 2-axle semitrailer and 2-axle booster.
Trailer Length	The length of the semitrailer, when fully deployed for transport. Fixed trailers cannot exceed 62 feet in length in this class of self-issued permit. If flip axles(s) are deployed, a flip neck extension is deployed or pinned axle(s) are added, the maximum trailer length is 65 feet. Stretch and Expanded trailers are allowed up to 65 feet in length. Special Use and Tow-away trailers are allowed up to 65 feet in length.
Trailer Type	Choose Fixed if the trailer is not reducible in length. Choose Stretch if the trailer is a telescoping stretch trailer. Choose Expanded if the trailer length has been expanded with deck extensions. Choose Special Use if the trailer is built to haul one type of commodity only. Choose Tow-away if the equipment is permanently mounted to a trailer. Select one of the following options for Fixed, Stretch or Expanded trailers in excess of 53 feet in length: <ol style="list-style-type: none"> 1. Choose Flip Axles(s) deployed if axles that can be flipped on the trailer are deployed to extend the hauling capacity of the trailer. 2. Choose Flip Neck Extension if a gooseneck at the front of the trailer is flipped down, to adjust axle weights of the combination. 3. Choose Pinned axle(s) if a separate vehicle is pinned to and does not pivot separately from the trailer, to add extra carrying capacity to the trailer. <p>Note: Both Flip Axle(s) deployed and Pinned axle(s) cannot be selected at the same time.</p> <p>Note: These three options are not available for Special Use or Tow-away trailers.</p>
Weight Table	For this class of permit, Weight Table 1 , 3 , or 4 are the only options.
Number of Axles	The number of axles on the ground. This is a required field if Weight Table 3 or 4 is selected.
List dimensions between axles...	This information is required for this class of self-issue permits, if Weight Table 3 or 4 is selected as part of the unladen authorization, and is used to calculate and confirm the appropriate weight table when unladen.
Group Axle Weights	This information is required for this class of self-issue permits, if Weight Table 3 or 4 is selected as part of the unladen authorization, and is used to calculate and confirm the appropriate weight table when unladen.

UNLADEN Route(s) Section	
Start Location	Choose Yes if the unladen move will begin at an Oregon border location. Choose the border location from the list. Choose No if the unladen move will begin in Oregon. Key the exact City, and Address, Cross Street, or Milepoint.
End Location	Choose Yes if the unladen move will end at an Oregon border location. Choose the border location from the list. Choose No if the unladen move will end in Oregon. Key the exact City, and Address, Cross Street, or Milepoint.
Route Description	Key the exact route, in order of travel. Include exit numbers where appropriate.

UNLADEN Pilot Vehicle Section	
2 Lane	Check None if no pilot vehicles are required for width, height, or overall length on any two-lane highways on the unladen route. Check Front if a front pilot vehicle is required for width, height, or overall length on any two-lane highways on the unladen route. Check Rear if a rear pilot vehicle is required for width on two-lane highways on the unladen route.
4 Lane	Check None if no pilot vehicles are required for width, height, or overall length on any multilane highways on the unladen route. Check Front if a front pilot vehicle is required for width, height, or overall length on any multilane highways on the unladen route. Check Rear if a rear pilot vehicle is required for width on multilane highways on the unladen route.

Vehicle Information	
Do you know...?	<p>Choose Yes if you know the power unit plate and/or unit number. Key a plate or unit number, and click Add Vehicle.</p> <p>Choose No if you do not know the power unit plate and/or unit number. Either choose a range of unit numbers, or Show All Vehicles. Select a power unit from the list.</p> <p>One and only one power unit is allowed on self-issue permits. Use of Equipment List is not allowed on self-issue permits. Use of multiple vehicles or option of vehicles is not allowed on self-issue permits.</p>

Special Provisions	
Pilot Vehicle Requirements	Key specific pilot vehicle requirements, based on the overall length, width, and height of the permitted move. If the pilot vehicle requirements checked above apply to the entire route, key or check the box "See above for pilot vehicle requirements for entire route."

Road Restrictions	Key specific road, ramp, and/or bridge restrictions that apply to the permit, based on the route, overall length, width, weight, and height of the permitted move. If no road restrictions apply, key or check the box "No additional road restrictions required for this route at these dimensions."
Other Special Provisions	Key other special provisions, or check one (or more) of the boxes below. If no additional special provisions, key or check the box "No additional special provisions required for this permit."
** Either certified flaggers...	Check this box if the permittee is required to straddle the centerline or use the certified rolling method to safely cross through a structure, due to the height and/or width. The ** is used in the Route to specify the structure where traffic control is required. The Certified Flagger Attachment will automatically be added as a requirement. The 18 locations where this is allowed are shown on Route Map 2 .
** Certified flaggers...	Check this box if the permittee is required to straddle the centerline to safely cross through a structure, due to the height and/or width. The ** is used in the Route to specify the structure where traffic control is required. The Certified Flagger Attachment will automatically be added as a requirement.
Front pilot vehicle must be equipped...	This checkbox will appear if the load is more than 14 feet 06 inches in height, and the carrier does not have a height declaration on file. The box cannot be unchecked.

Final Details	
Location	If TOL is chosen, the permit will only appear in the carrier's TOL reprint area. The carrier will need to log in to their TOL account to obtain the permit. If HOSTFAX is chosen, please provide a 10-digit fax number, or up to 4-digit INC code in the Hostfax Number field. In addition to the carrier's TOL reprint area, the permit will be sent to this fax number.
Checkbox	The person issuing the permit must read the text, and check the box, if they agree.

S43 – Solo Vehicle

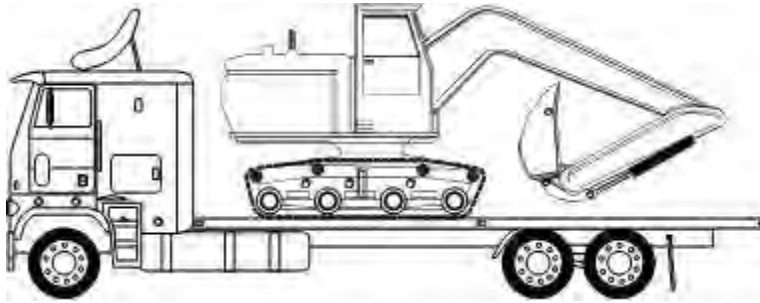

This permit class is intended for solo vehicles. Legal axle weights required if hauling multiple items. Operations allowed with heavy haul axle and/or group axle weights, up to [Weight Table 4](#), when hauling a single, non-divisible item.

Carrier Information Section	
Contact Name	First and last name of the person issuing the permit.
Phone Number	10-digit phone number of the person issuing the permit.
Email	When the self-issue permit is issued, an email will be sent to this email address, advising where to print it. The default email address is the email address assigned to the Oregon Trucking Online Account.
Permit Effective Date	The date that you want the self-issue permit to be effective. Self-issue permits are valid for up to 10 days, and must expire no more than 14 days from today's date.
Permit Expiration Date	The date that you want the self-issue permit to expire. Self-issue permits are valid for up to 10 days, and must expire no more than 14 days from today's date.

Non-Divisible Load Dimensions Section	
Commodity	The specific item being hauled. Examples of <u>acceptable</u> entries include Backhoe, D6 Dozer With Blade, or Air Handling Unit. Examples of <u>unacceptable</u> entries include Construction Equipment, Machinery, HVAC Parts, and Building Materials.
Load Length	If the load is 40 feet or less in length, enter 40 . If the load is greater than 40 feet in length, enter the total load length rounded up to the next foot. The maximum load length for this class of self-issue permit is 50 feet.
Width	The total overall width of the load or hauling equipment, whichever is greater. Round fractions of an inch up to the next highest inch. Legal width in Oregon is 8 feet 06 inches. Enter 8'06" if the width is 8 feet 06 inches or less. Enter the actual width if the width is more than 8 feet 06 inches. Hauling a legal width load on an overwidth vehicle is not allowed. The maximum width allowed in the Self-Issue Permits Program is 14 feet 00 inches.

<p>Travel Height</p>	<p>The highest point of the load when prepared and ready for transport, as measured from the ground on a level surface. Round fractions of an inch up to the next highest inch. Legal height in Oregon is 14 feet 00 inches. Enter 14'00" if the height is 14 feet 00 inches or less. Enter the actual height if the height is more than 14 feet 00 inches.</p> <p>The maximum height allowed in the Self-Issue Permits Program is 15 feet 00 inches.</p>
<p>Overall Length</p>	<p>Total length of the hauling equipment and the load, including any front and/or rear overhangs, rounded up to the nearest foot. Multiple items loaded end to end cannot exceed 3/4 wheelbase rear overhang, subject to allowable overall lengths.</p> <p>An error message will appear if the following are keyed:</p> <ul style="list-style-type: none"> • The overall length is less than the load length. • If weights and spacings are provided, the overall length is less than the sum of the spacings. <p>The maximum overall length allowed in the Self-Issue Permits Program for a solo vehicle is 50 feet.</p>
<p>Front Overhang</p>	<p>The distance that any part of the load extends beyond the forward most part of the body of the power unit. Legal front overhang is 4 feet 00 inches. Enter Legal if front overhang is 4 feet 00 inches or less. Enter the actual front overhang in feet when it exceeds 4'00 inches, rounded up to the next highest foot.</p> <p>A load cannot have both excessive front and rear overhang at the same time.</p> <p>Refer to pilot vehicle table on Attachment 82A for pilots required for front overhang.</p> <p>The maximum front overhang allowed in the Self-Issue Permits Program is 40 feet 00 inches.</p>
<p>Rear Overhang</p>	<p>Rear overhang is measured from the center of the last axle of the vehicle to the end of the load, and is subject to overall length limits. Wheelbase is the distance measured from the center of the first axle of the vehicle, to the center of the last axle of the vehicle. Items loaded end-to-end or overlapping are not allowed to exceed 3/4 wheelbase rear overhang.</p> <p>Choose 3/4WB if rear overhang is less than or equal to 3/4 of the wheelbase of the vehicle.</p> <p>Choose 100WB if rear overhang is more than 3/4, up to 100% of the wheelbase of the vehicle. The maximum rear overhang allowed in this class of Self-Issue Permits Program is 100% of the wheelbase, measured from the center of the last axle of the vehicle to the end of the load.</p> <p>Refer to Attachment 82A for flag and lighting requirements when a load extends off the rear of the vehicle.</p>

Gross Weight	If hauling multiple items, key LEGAL (which is 80,000 pounds). If hauling a single, non-divisible item, key the gross weight of the hauling equipment and load, in pounds. The maximum gross weight allowed in the Self-Issue Permits Program is 200,000 pounds.
Description of Vehicles	For this class of permit, Solo Vehicle is the only option, and cannot be edited.
Weight Table	For this class of permit, Weight Table 1 , 3 or 4 are the only options. When operating under Weight Table 3 or 4, the weight table chosen must match the weight table calculated by the weights and spacings provided below.
Number of Axles	The number of axles on the ground. This field is required when operating under Weight Table 3 or 4. When operating under Weight Table 3 or 4, all auxiliary axles must be deployed.
Optionally, select a saved Weight Analysis...	If you have a weight analysis saved from the Calculate Oregon Weights application in the OD Menu of TOL, select it from the list. You will still need to key the Weight Table, Number of Axles, and Gross Weight.
List dimensions between axles...	This information is required for this class of self-issue permit when operating under Weight Table 3 or 4, and is used to calculate and confirm the appropriate weight table.
Group Axle Weights	This information is required for this class of self-issue permit when operating under Weight Table 3 or 4, and is used to calculate and confirm the appropriate weight table.

Unladen Travel	
Unladen Travel Requested?	Choose Yes if unladen authorization is required because the hauling equipment (trailer and/or overall length) exceeds the legal length limits shown on Group Map 1 .
How many segments...?	Up to two unladen segments are allowed on each single-trip permits. If the gross weight is in excess of 98,000 pounds when unladen, a separate single-trip permit is required.

Route Section	
Start Location	Choose Yes if the laden move will begin at an Oregon border location. Choose the border location from the list. Choose No if the laden move will begin in Oregon. Key the exact City, and Address, Cross Street, or Milepoint.
End Location	Choose Yes if the laden move will end at an Oregon border location. Choose the border location from the list. Choose No if the laden move will end in Oregon. Key the exact City, and Address, Cross Street, or Milepoint.
Route Description	Key the exact route, in order of travel. Include exit numbers where appropriate.

Pilot Vehicle Section	
2 Lane	Check None if no pilot vehicles are required for width, height, or overall length on any two-lane highways on the laden route. Check Front if a front pilot vehicle is required for width, height, or overall length on any two-lane highways on the laden route. Check Rear if a rear pilot vehicle is required for width on any two-lane highways on the laden route.
4 Lane	Check None if no pilot vehicles are required for width, height, or overall length on any multilane highways on the laden route. Check Front if a front pilot vehicle is required for width, height, or overall length on any multilane highways on the laden route. Check Rear if a rear pilot vehicle is required for width or length on multilane highways on the laden route.

UNLADEN Load Dimensions Section	
Commodity	The default is Unladen Combination.
Load Length	The default is Legal .
Width	The total overall width of the hauling equipment.
Travel Height	The height of the hauling equipment as measured from a flat surface, ready for transport. Show the actual loaded height when operating greater than 14 feet 00 inches. Otherwise, indicate 14'00" .
Overall Length	The overall length of the hauling equipment.
Front Overhang	The default is Legal .
Rear Overhang	The default is Legal .
Gross Weight	The default is Legal . The maximum gross weight for an unladen section of a single-trip permit is 98,000 pounds.
Description of Vehicles	The default is Solo Vehicle .
Weight Table	For this class of permit, Weight Table 1 , 3 , or 4 are the only options.
Number of Axles	The number of axles on the ground. This is a required field if Weight Table 3 or 4 is selected. When operating under Weight Table 3 or 4, all auxiliary axles must be deployed.
List dimensions between axles...	This information is required for this class of self-issue permits, if Weight Table 3 or 4 is selected as part of the unladen authorization, and is used to calculate and confirm the appropriate weight table when unladen.
Group Axle Weights	This information is required for this class of self-issue permits, if Weight Table 3 or 4 is selected as part of the unladen authorization, and is used to calculate and confirm the appropriate weight table when unladen.

UNLADEN Route(s) Section	
Start Location	Choose Yes if the unladen move will begin at an Oregon border location. Choose the border location from the list. Choose No if the unladen move will begin in Oregon. Key the exact City, and Address, Cross Street, or Milepoint.
End Location	Choose Yes if the unladen move will end at an Oregon border location. Choose the border location from the list. Choose No if the unladen move will end in Oregon. Key the exact City, and Address, Cross Street, or Milepoint.
Route Description	Key the exact route, in order of travel. Include exit numbers where appropriate.

UNLADEN Pilot Vehicle Section	
2 Lane	Check None if no pilot vehicles are required for width, height, or overall length on any two-lane highways on the unladen route. Check Front if a front pilot vehicle is required for width, height, or overall length on any two-lane highways on the unladen route. Check Rear if a rear pilot vehicle is required for width on two-lane highways on the unladen route.
4 Lane	Check None if no pilot vehicles are required for width, height, or overall length on any multilane highways on the unladen route. Check Front if a front pilot vehicle is required for width, height, or overall length on any multilane highways on the unladen route. Check Rear if a rear pilot vehicle is required for width on multilane highways on the unladen route.

Vehicle Information	
Do you know...?	<p>Choose Yes if you know the power unit plate and/or unit number. Key a plate or unit number, and click Add Vehicle.</p> <p>Choose No if you do not know the power unit plate and/or unit number. Either choose a range of unit numbers, or Show All Vehicles. Select a power unit from the list.</p> <p>One and only one power unit is allowed on self-issue permits. Use of Equipment List is not allowed on self-issue permits. Use of multiple vehicles or option of vehicles is not allowed on self-issue permits.</p>

Special Provisions	
Pilot Vehicle Requirements	Key specific pilot vehicle requirements, based on the overall length, width, and height of the permitted move. If the pilot vehicle requirements checked above apply to the entire route, key or check the box "See above for pilot vehicle requirements for entire route."

Road Restrictions	Key specific road, ramp, and/or bridge restrictions that apply to the permit, based on the route, overall length, width, weight, and height of the permitted move. If no road restrictions apply, key or check the box "No additional road restrictions required for this route at these dimensions."
Other Special Provisions	Key other special provisions, or check one (or more) of the boxes below. If no additional special provisions, key or check the box "No additional special provisions required for this permit."
** Either certified flaggers...	Check this box if the permittee is required to straddle the centerline or use the certified rolling method to safely cross through a structure, due to the height and/or width. The ** is used in the Route to specify the structure where traffic control is required. The Certified Flagger Attachment will automatically be added as a requirement. The 18 locations where this is allowed are shown on Route Map 2 .
** Certified flaggers...	Check this box if the permittee is required to straddle the centerline to safely cross through a structure, due to the height and/or width. The ** is used in the Route to specify the structure where traffic control is required. The Certified Flagger Attachment will automatically be added as a requirement.
Front pilot vehicle must be equipped...	This checkbox will appear if the load is more than 14 feet 6 inches in height, and the carrier does not have a height declaration on file. The box cannot be unchecked.

Final Details	
Location	If TOL is chosen, the permit will only appear in the carrier's TOL reprint area. The carrier will need to log in to their TOL account to obtain the permit. If HOSTFAX is chosen, please provide a 10-digit fax number, or up to 4-digit INC code in the Hostfax Number field. In addition to the carrier's TOL reprint area, the permit will be sent to this fax number.
Checkbox	The person issuing the permit must read the text, and check the box, if they agree.

Appendix A: Height Restrictions

Spreadsheets of height restrictions over and under Interstate, US, and OR routes are included here. All known structures under 15 feet 00 inches vertical clearance are documented. No reference will be made to permissible height when clearance is over 15 feet 00 inches, as this is outside the blanket of the Self-Issue Permits Program. Carriers must order a single-trip permit from the Over-Dimension Permit Unit when operating in excess of 15 feet 00 inches height.

This information is only available to those that are certified in the [Self-Issue Permits Program](#).

Appendix B: Exit Numbers

Exit Numbers must be used when leaving a state highway. Except when:

- Exiting from one Interstate to another Interstate. Use of that exit number is allowed but not required.
- No exit number exists.

The following spreadsheets show required exit numbers. Note that exit numbers may be different depending on the direction of travel.

Interstate 5

SB I-5 Exit #	Description	NB I-5 Exit #
308	Jantzen Beach	308
307	OR99E, Marine Drive	307
306	Interstate Ave.	
	Expo Center, Victory Blvd.	306B
	Columbia Blvd.	306A
	WB US30 Bypass	305B
	EB US30 Bypass	305A
304	Rosa Parks Way	304
303	Swan Island, Killingsworth St.	303
	Greeley Ave, Swan Island	302C
302B	SB I-405, WB US30	302B
302A	Moda Center	302A
301	EB I-84	
	EB I-84	300
300B	EB US26, OR99E	
No Exit #	NB I-405	299B
	OR43, US26	299A
	Corbett Ave.	298
297	Terwilliger Blvd.	297
296B	Multnomah Blvd.	
296A	Barbur Blvd.	
295	Taylor's Ferry Road, Capitol Highway	295
294	Barbur Blvd, OR99W	294
293	Haines St	293

SB I-5 Exit #	Description	NB I-5 Exit #
292	OR217, Kruse Way	
	Kruse Way, 72nd Ave	292B
	NB OR217	292A
291	Carman Drive	291
290	Lower Boones Ferry Road	290
289	Tualatin-Sherwood Road, Nyberg St.	289
288	NB I-205	288
286	N Wilsonville (Boones Ferry Road/OR141)	286
283	Wilsonville	283
	Canby	282
282B	Charbonneau District	
282A	OR551, Canby	
278	Ehlen Road	278
271	OR214, OR219	271
263	Brooklake Road, Brooks	263
	Chemawa Road	260
260B	Chemawa Road	
260A	OR99E Business, Salem Parkway	
258	NB OR99E	258
256	Market St.	256
253	OR22/OR99E Business	253
252	Kuebler Blvd.	252
249	Commercial St.	249
248	Sunnyside, Turner	248
244	North Jefferson (OR164)	244
243	Ankeny Hill Road	243
242	Talbot Road	242
239	Dever-Connor Road	239
238	South Jefferson (OR164)	238
237	Viewcrest	
235	Century Drive, Millersburg	235
	Knox Butte Road	234

SB I-5 Exit #	Description	NB I-5 Exit #
234B	SB OR99E	
234A	Knox Butte Road	
233	US20	233
228	OR34	228
216	OR228	216
209	Diamond Hill Drive	209
199	Pearl St., Coburg	199
195	OR569	
	WB OR569	195B
	EB OR569	195A
194B	WB OR126	194B
194A	EB OR126	194A
192	NB OR99/OR126 Business	192
191	Glenwood Blvd.	191
189	30th Ave., McVay Highway (OR225)	189
188	EB OR58	
	Franklin Blvd.	188B
	EB OR58	188A
186	Goshen	186
182	Springfield, Creswell (OR222)	182
176	Saginaw	176
174	OR99, Row River Road	174
172	Yoncalla, Drain	
	NB OR99	170
163	Curtin, Lorane	163
162	OR38/OR99	162
	Anlauf, Lorane	161
160	Salt Springs Road	160
159	Anlauf	159
154	Scotts Valley, Elkhead	154
150	Yoncalla, Drain	150
148	Rice Hill	148

SB I-5 Exit #	Description	NB I-5 Exit #
146	Rice Valley	146
142	Metz Hill	142
140	Oakland	
	Oakland	138
136	OR138	136
135	Wilbur, Sutherlin	135
129	Del Rio Road	129
127	Edenbower Blvd.	127
125	Garden Valley Blvd.	125
124	OR138	124
123	Portland Ave.	123
121	McLain Ave.	121
120	Old Highway 99, South Roseburg	120
119	OR42	119
113	Clarks Branch Road	113
112	Old Highway 99, Dillard	112
110	Boomer Hill Road	110
108	Myrtle Creek Road	108
106	Weaver Road	106
103	Tri-City, Myrtle Creek, Riddle	103
102	Gazley Road	102
101	Riddle	101
99	North Canyonville	99
98	Days Creek, Canyonville	98
95	Canyon Creek	95
88	Azalea, Galesville Reservoir	88
86	Quines Creek Road	86
83	Barton Road	83
80	Glendale Valley Road	80
76	Wolf Creek	76
71	Sunny Valley	71
66	Monument Drive (Hugo)	66

SB I-5 Exit #	Description	NB I-5 Exit #
61	Monument Drive (Merlin)	61
58	OR99/US199	58
55	Grants Pass Parkway	55
48	Depot St., Rogue River	48
45B	Valley of the Rogue State Park	45B
45A	OR99	
43	OR99	43
40	Gold Hill (OR99/OR234)	40
35	Blackwell Road, OR99	35
33	E Pine St.	33
30	OR62	30
27	Barnett Road, Garfield St.	27
24	Fern Valley Road	24
21	West Valley View Road	21
19	South Valley View Road	19
14	OR66	14
	NB OR99	11
6	Mt Ashland (OR273)	6
	Siskiyou Hwy (OR273)	1

Interstate 82

SB I-82 Exit #	Description	NB I-82 Exit #
1	US730	1
5	Powerline Road	5
10	Westland Road	10

Interstate 84

EB I-84 Exit #	Description	WB I-84 Exit #
1	33rd Ave.	
	Lloyd Center	1
2	39th Ave.	
	43rd Ave.	2

EB I-84 Exit #	Description	WB I-84 Exit #
3	NE 58th Ave.	
4	NE 68th Ave.	
5	SE 82nd Ave.	
6	SB I-205	9
7	Halsey St.	
8	NB I-205	9
10	NE 122nd Ave.	
13	NE 181st Ave.	13
14	Fairview Parkway	14
16	NE 238th Drive	16
17	Marine Drive, 257th Ave., Troutdale	17
18	Jordan Road	18
22	Corbett	22
25	Rooster Rock State Park	25
28	Bridal Veil	
	Dalton Point	29
30	Benson State Recreation Area	
31	Multnomah Falls	31
35	Ainsworth State Park	35
	Warrendale	37
40	Bonneville Dam	40
41	Eagle Creek Recreation Area	
44	US30, Cascade Locks	44
	Forest Lane, Herman Creek	47
51	Wyeth	51
55	Starvation Creek Trailhead	
56	Viento State Park	56
58	Mitchell Point Overlook	58
60	US30, West Hood River	60
63	Hood River City Center	63
64	OR35, White Salmon	64
69	US30, Mosier	69

EB I-84 Exit #	Description	WB I-84 Exit #
76	Rowena	76
82	Columbia Gorge Discovery Center	82
83	West The Dalles	
84	The Dalles City Center	84
85	The Dalles City Center	85
87	US197	87
88	The Dalles Dam	88
97	OR206	97
104	US97	104
109	Rufus, John Day Dam	109
	John Day Viewpoint	112
114	John Day River	114
123	Phillipi Canyon	123
129	Blalock Canyon	129
131	Woelpern Road	
137	OR19, Arlington	137
147	OR74	147
151	Three Mile Canyon	151
159	Tower Road	159
164	Boardman	164
165	Port of Morrow	165
168	US730	168
171	Patterson Ferry Road	171
177	Umatilla Army Depot	177
179	I-82	179
180	Westland Road	180
182	OR207	182
188	US395, OR320	188
193	Echo Road	193
198	Lorenzen Road	198
199	Yoakum Road	199
202	Barnhart Road	202

EB I-84 Exit #	Description	WB I-84 Exit #
207	US30, Pendleton	207
209	US395	209
210	OR11	210
	US30, Pendleton	213
216	OR331 (Mission Cutoff)	216
224	Poverty Flat Road	224
228	Deadman Pass	228
234	Emigrant Springs State Park	234
238	Meacham	238
243	Summit Road	243
248	Spring Creek Road	248
252	OR244	252
256	Perry	257
259	US30, La Grande	
261	OR82	261
265	OR203, US30	265
268	Foothill Road	268
270	Ladd Creek Road	270
273	Frontage Road (Ladd Canyon Road)	273
278	Clover Creek	278
283	Wolf Creek Lane	283
285	US30, OR237, North Powder	285
298	OR203	298
302	OR86	302
304	OR7	304
306	US30, Baker City	306
313	Pleasant Valley	317
327	Durkee	327
330	Cement Plant Road	330
335	Weatherby	335
338	Lookout Mountain	338
340	Rye Valley	340

EB I-84 Exit #	Description	WB I-84 Exit #
342	US30, Lime	
345	US30, Huntington, Lime	345
353	US30, Fairwell Bend	353
356	OR201	356
362	Moore's Hollow Road	362
371	Stanton Blvd. (OR457)	371
374	OR201	374
376A	US30 Business	376A
376B	US30, Payette	376B

Interstate 105

EB I-105 Exit #	Description	WB I-105 Exit #
1	Delta Highway	1
2	Country Club Road, Coburg Road	2
4A	I-5 SB	4A
4B	I-5 NB	4B

Interstate 205

SB I-205 Exit #	Description	NB I-205 Exit #
24	Airport Way	
	EB Airport Way	24B
	WB Airport Way, Portland Airport	24A
23B	WB US30 Bypass	23B
23A	EB US30 Bypass	23A
22	EB I-84	22
21B	WB I-84	21B
21A	NE Glisan St.	21A
	Washington St., Stark St.	20
19	US26, Powell Blvd., Division St.	19
17	Foster Road	17
16	Johnson Creek Blvd.	16
14	Sunnyside Road, Sunnybrook Blvd.	14

SB I-205 Exit #	Description	NB I-205 Exit #
13	WB OR224, NB OR213	13
12B	Webster Road	
12A	EB OR212/OR224	12
11	82nd Drive, Gladstone	11
10	SB OR213	10
9	OR99E	9
8	OR43	8
6	10th St., West Linn	6
3	Stafford Road, Lake Oswego	3

Interstate 405

SB I-405 Exit #	Description	NB I-405 Exit #
3	WB US30	3
2B	Everett St.	2B
2A	Couch St., Burnside St.	
	Salmon St., PGE Park	2A
1D	WB US26	1D
1C	EB US26, Ross Island Bridge, 6th Ave.	1C
	4th Ave.	1B
	Naito Parkway	1A

US26

EB US26 Exit #	Description	WB US26 Exit #
55	Dersham Road, Mountaindale	55
57	Glencoe Road, North Plains	57
59	Jackson School Road	59
61	Helvetia Road, Brookwood Parkway	61
62	Cornelius Pass Road	
	SB Cornelius Pass Road	62A
	NB Cornelius Pass Road	62B
64	185th Ave.	64
65	Bethany Blvd., Cornell Road	65

EB US26 Exit #	Description	WB US26 Exit #
67	Murray Blvd.	67
68	Cedar Hills Blvd.	68
69A	OR217	69A
	Cedar Hills Blvd, Barnes Road	69B
	OR8	71A
71	Sylvan	71B
72	Zoo	72
73	Jefferson St.	

US97

SB US97 Exit #	Description	NB US97 Exit #
119	Canal Blvd.	119
135A	US20, US97 Business	135A
	Empire Blvd.	135B
136	Butler Market Road	
137	Revere Ave.	137
138	Downtown Bend	138
139	Reed Market Road	139
153	South Century Drive	153
247	OR422, Chiloquin	247

OR22

EB OR22 Exit #	Description	WB OR22 Exit #
1A	SB I-5	1A
1B	NB I-5	1B
2	Lancaster Drive	2
4	Deer Park Road, Gaffin Road	4
5	Joseph St.	5
7	OR214	7
9	Shaw, Aumsville	9
12	Golf Club Road	12

Appendix C: County Contact Information

It is the carrier's responsibility to obtain approval from the appropriate road authorities (i.e. cities, counties) prior to making the move. If approval is obtained, and the route is listed on the self-issue permit, include the name of the city/county, the approving person, and the fees associated with that approval.

Although the links can change without notice, ODOT maintains a list of County Public Works websites:

<https://www.oregon.gov/odot/Pages/County-Public-Works.aspx>

The phone numbers below are provided as a convenience to the motor carrier.

Appendix C – County Phone Number List			
County Name	Phone Number	County Name	Phone Number
Baker	541-523-6417	Lake	541-947-6048
Benton	541-766-6821	Lane	541-682-6902
Clackamas	888-387-8259	Lincoln	541-574-1202
Clatsop	503-325-8631	Linn	541-967-3919
Columbia	503-397-5090	Malheur	541-473-5191
Coos	541-396-7660	Marion	503-584-7710
Crook	541-447-4644	Morrow	541-989-9500
Curry	541-247-7097	Multnomah	503-988-3582
Deschutes	541-388-6581	Polk	503-623-9287
Douglas	541-440-4481	Sherman	541-565-3271
Gilliam	541-384-3998	Tillamook	503-842-3419
Grant	541-575-0138	Umatilla	541-278-5512
Harney	541-573-6356	Union	541-963-1016
Hood River	541-386-2616	Wallowa	541-426-3332
Jackson	541-774-8184	Wasco	541-506-2640
Jefferson	541-475-4459	Washington	503-846-7623
Josephine	541-474-5460	Wheeler	541-763-2911
Klamath	541-883-4696	Yamhill	503-434-7370